

Power Supply

IEI power supply solutions are complete and flexible. Normal (PS2, 1U, 2U) or redundant form, close or open frame, DC or AC input, AT or ATX model, 10 to 600 watts or higher, all of these features are available within a reliable and highly efficient power solution.

IEI's embedded system power supply solution is efficient and stable. IEI also provides customized power supply services to meet your demands.

Selection

■ Open Frame

- Fanless Chassis

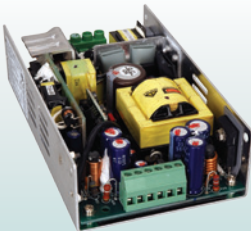

■ 1U Series

- 1U Chassis



■ 2U Series

- 1U ~ 2U Chassis



■ PS2 Series

- 2U ~ 4U Chassis



■ Redundant

- 2U ~ 4U Chassis



■ Adapter

- LCD Monitor
- AFL Series
- Embedded System



■ DC to DC Module

- Battery Backup System
- Embedded System
- Mobile Auto Solution

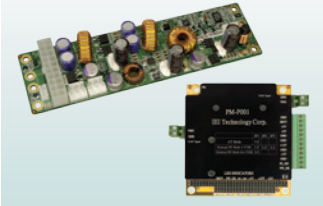

1

Industrial Computing Solutions

2

Video Capture Solutions

3

Industrial Computer Chassis

4

Open Frame Monitor

5

Power Supply/ Peripherals

6

All-in-One System



AC-DC Adapter



Type	Temperature
AC-DC Adapter	0°C ~ 40°C

Current

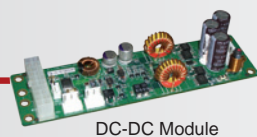
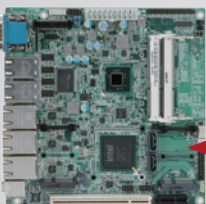

DC-DC Module



AC-DC Adapter



AC

Wide Temperature

0°C ~ 70°C

Item	Model	Watt	AC/DC
1U	ACE-717CX	170W	24 DC

Medical

Item	Model	Watt	AC/DC
PS/2	ACE-4840APM	400W	AC
	ACE-828M	280W	AC
Open Frame	ACE-713APM	130W	AC
	ACE-706AM	60W	AC

-20°C ~ 70°C

Item	Model	Watt	AC/DC
PS/2	ACE-A160A	600W	AC
	ACE-A140A	400W	AC
	ACE-A130B	300W	AC
	ACE-932A	300W	AC
	ACE-828A	280W	AC
	ACE-828M	280W	AC
1U	ACE-932T	300W	48 DC
	ACE-A225A	250W	AC
	ACE-716A	150W	AC
	ACE-716AP	150W	AC
2U	ACE-716C	150W	24 DC
2U	ACE-723T	200W	48 DC
Open Frame	ACE-713APM	130W	AC

80 PLUS & ErP

80 PLUS

The 80 PLUS power supply saves energy and money to keep up with the latest market trends.

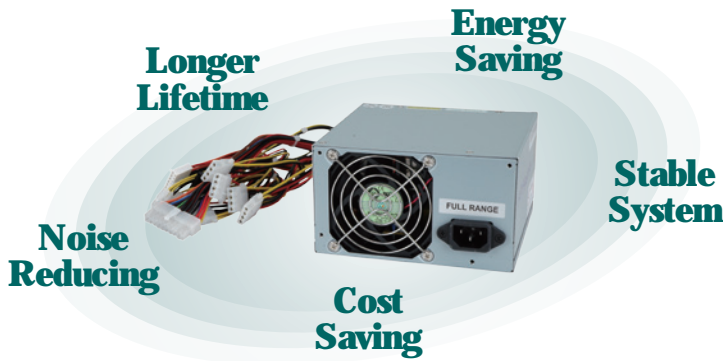

Efficiency Trend

Multiple output for computers and servers Eff. ≥ 80% at 20%, 50% and 100% of rated load PFC ≥ 0.9

	80 PLUS	80 PLUS BRONZE	80 PLUS SILVER
20% (loading)	80%	82%	85%
50% (loading)	80%	85%	88%
100% (loading)	80%	82%	85%

Energy Saving

A high efficiency power supply saves energy by reducing the amount of energy used during the current transferring process.

System Reliability

Reducing the heat output helps to lower the system temperature and increase system reliability.

Cost Saving

A high efficiency power supply reduces energy consumption, which means savings on your electric bills.

Noise Reducing

A high efficiency power supply can achieve a lower operating temperature. When the fan operates at a lower speed, it produces less noise.

Longer Lifetime

A high efficiency power supply can reduce heat generated inside the power supply and increase its operating hours.

ErP

ErP → Energy-Related Products

These products are aimed at improving energy efficiency and reducing energy consumption.

Scope: Anything that is Class B EMC (Class A out of scope)

Power Supply

Off mode & Standby mode

Off mode	≤ 1.0 W
Standby mode	≤ 1.0 W



Adapter

Maximum Energy Consumption in No-Load Mode

Output power	AC-DC external power supplies, except low voltage external power supplies	Low voltage external power supplies
≤ 51W	0.30W	0.30W
Po > 51W	0.50W	N/A

1

Industrial Computing Solutions

2

Video Capture Solutions

3

Industrial Computer Chassis

4

Open Frame Monitor

5

Power Supply/ Peripherals

6

All-in-One System

Open Frame Selection Guide

Safety (ITE Standard) - CB IEC 60950, UL 60950, CSA C 22.2 No. 60950, TUV EN 60950





Safety (Medical Standard) - CB IEC 60601, UL 60601, CSA C 22.2 No. 60601, TUV EN 60601

EMI - Meets EN 55022, FCC Part 15, CISPR 22

Meets EN 61000-3-2, EN 61000-3-3 (PFC function)

EMS - Meets EN 55024, EN 61000-4-2/3/4/5/6/8/11

* For detailed specs, please refer to official certification

AC Input													
Product	Model No.	Watt AT/ATX PFC	Input Range Voltage	Output Current Range					Efficiency	Operating Temperature	Safety	Dimensions (mm)	
				+5 V	+12 V	-5 V	-12 V	+5 Vsb					
	Medical ACE-713APM	130W ATX PFC	85 - 264 VAC	10 A (0.2 A min.)	6 A		0.5 A	0.5 A	80%	-20°C ~ 70°C	CB UL TUV CCC CE	152.4 x 89 x 39	
	ACE-890A	86W AT -	85 - 264 VAC	10 A	2.5 A		0.5 A		70%	0°C ~ 50°C	CSA CE	152.4 x 89 x 39	
	ACE-870A	70W AT -	85 - 264 VAC	7 A	2.5 A	0.3 A	0.3 A		70%	0°C ~ 50°C	UL	127 x 81 x 50	
	Medical ACE-706AM	60W AT -	90 - 264 VAC	3 A	3 A		0.3 A		82%	0°C ~ 70°C	CB UL TUV CCC CE	63.5 x 114.3 x 32.4	
DC Input													
	ACE-890C	86W AT -	24 VDC (18 - 36 VDC)	10 A	2.5 A		0.5 A		70%	0°C ~ 50°C	UL CSA TUV CE	152.4 x 89 x 39	

1 Industrial Computing Solutions

2 Video Capture Solutions

3 Industrial Computer Chassis

4 Open Frame Monitor

5 Power Supply/ Peripherals

6 All-in-One System

Open Frame AC Input ATX Type

ACE-713APM 130 W Medical Type ATX Power Supply with PFC



Dimensions (Unit: mm)

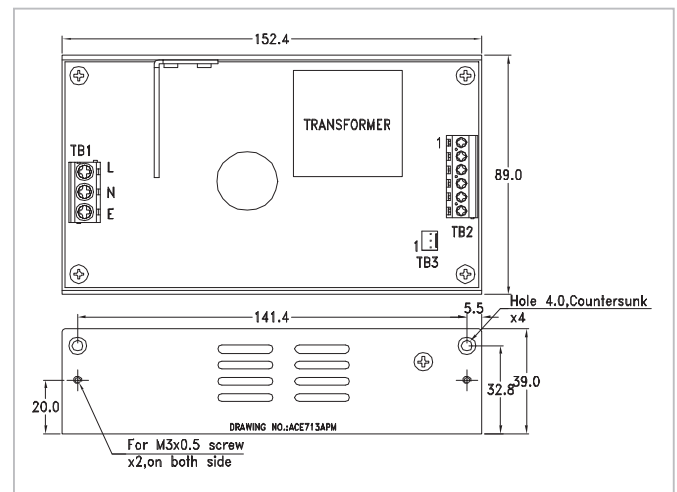

Input Type	85 - 264 VAC Full Range					
Input Frequency	47 Hz ~ 63 Hz					
Input Current	2A (RMS)@115VAC, 1A (RMS)@230VAC					
Inrush Current	30A max. for 115VAC, 60A max. for 230VAC					
Output Voltage	+3.3V	+5V	+12V	-5V	-12V	+5Vsb
		10A (0.2A min.)	6A		0.5A	0.5A
Efficiency	80%					
Temperature	Operating: -20°C ~ 70°C (50°C ~ 70°C derating curve) Storage: -40°C ~ 75°C					
MTBF (hrs)	143,000					
Output Connector	5VSB & PS_ON cable					
Dimensions (mm)	152.4 x 89 x 39					

Ordering Information

Part No.	Description
ACE-713APM-RS	130W AC-DC ATX Power Supply with PFC, meets medical standards

Option 1



Embedded Solution

PN: CB-709EB-RS
30 cm DC cable to backplane, with 20-pin ATX, HDD and SATA connectors

Open Frame AC Input AT Type

ACE-890A

86 W AC-DC Open Frame AT Power Supply



PFC



Input Type	85 ~ 264 VAC Full Range				
Input Frequency	47 Hz ~ 63 Hz				
Input Current	2A (RMS)@115VAC, 1A (RMS)@230VAC				
Inrush Current	25A max. for 115VAC, 50A max. for 230VAC				
Output Voltage	+5 V	+12 V	-5 V	-12 V	+24 V
ACE-890A	10 A	2.5 A		0.5 A	
Efficiency	70%				
Temperature	0°C ~ 50°C (Operating), -20°C ~ 85°C (Storage)				
MTBF (hrs)	268,000				
Output Connector	Optional cable				
Dimensions (mm)	152.4 x 89 x 39				

Ordering Information

Part No.	Description
ACE-890A-RS	86W AC-DC Open Frame AT Power Supply

Dimensions (Unit: mm)

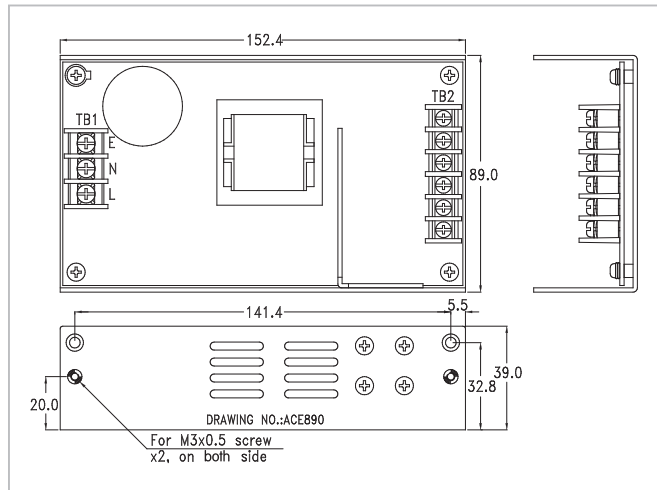

Option 1

AT P8P9 Backplane Solution



PN: CB-890P8P9-RS

30 cm DC cable AT power to P8P9, HDD and SATA connectors

ACE-870A

70 W AC-DC Open Frame AT Power Supply



PFC



Input Type	85 ~ 264VAC Full Range				
Input Frequency	47 Hz ~ 63 Hz				
Input Current	1.5A (RMS)@115VAC, 0.8A (RMS)@230VAC				
Inrush Current	25A max. for 115VAC, 50A max. for 230VAC				
Output Voltage	+5V	+12V	-5V	-12V	+24V
ACE-870A	7A	2.5A	0.3A	0.3A	
Efficiency	70%				
Temperature	0°C ~ 50°C (Operating), -20°C ~ 85°C (Storage)				
MTBF (hrs)	296,000				
Output Connector	Optional cable				
Dimensions (mm)	127 x 81 x 50				

Ordering Information

Part No.	Description
ACE-870A-RS	70W AC-DC Open Frame AT Power Supply

Dimensions (Unit: mm)

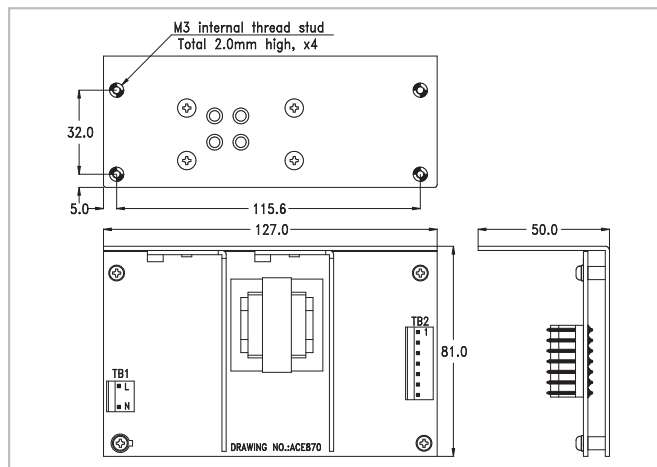

Option 1

AC Input Solution



PN: CB-870EC-RS

20 cm AC input cable with fuse

Option 2

AT P8P9 Backplane Solution



PN: CB-870P8P9-RS

30 cm DC cable AT power to P8P9, HDD and SATA connectors

1

Industrial Computing Solutions

2

Video Capture Solutions

3

Industrial Computer Chassis

4

Open Frame Monitor

5

Power Supply/ Peripherals

6

All-in-One System

ACE-706AM

60 W AC-DC Open Frame Medical AT Power Supply

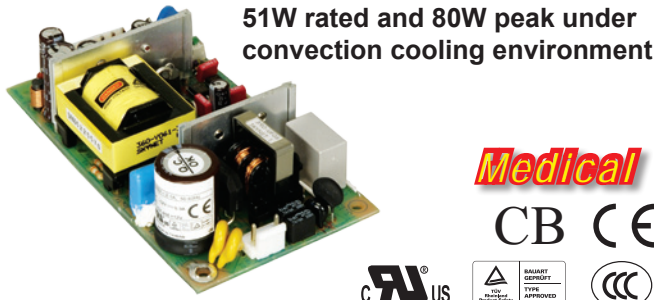

Dimensions (Unit: mm)

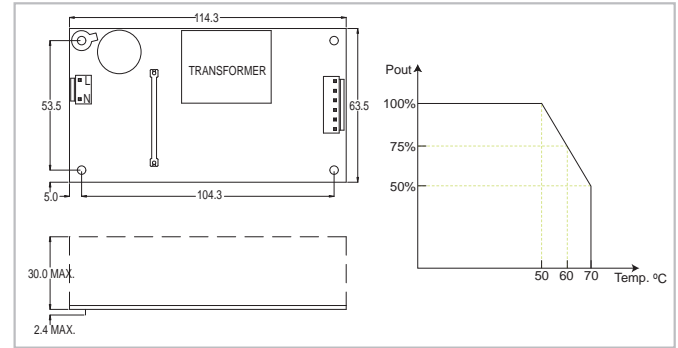

Input Type	90 ~ 264 VAC Full Range			
Input Frequency	47 Hz ~ 63 Hz			
Input Current	2 A (RMS) @ 115V, 1 A (RMS) @ 230V			
Inrush Current	30 A max. for 115VAC, 60 A max. for 230VAC			
Output Voltage	Voltage	Min. load	Max. load	Ripple & Noise
	+5 V	0 A	4.5 A	1%
	+12 V	0 A	4 A	1%
	-12 V	0 A	0.3 A	1%
Efficiency	82%			
Temperature	Operating: 0°C ~ 70°C, Storage: -40°C ~ 85°C			
MTBF (hrs)	100,000			
Output Connector	Optional cable			
Dimensions	63.5 x 114.3 x 32.4 (mm), 2.5 x 4.5 x 1.28 (inch)			

Ordering Information

Part No.	Description
ACE-706AM-RS	60W AC-DC Open Frame Medical AT Power Supply, RoHS

Option 1	AC Input Solution
	PN: CB-704EC-RS 20 cm AC input cable with fuse
Option 2	Embedded Solution
	PN: 32102-037300-100-RS Substitute of CB-704EB-RS, 30 cm DC cable to CPU board, with 4-pin 12 V CPU, HDD and SATA connectors



Open Frame DC Input AT Type

ACE-890C

DC Input Open Frame AT Power Supply



Dimensions (Unit: mm)

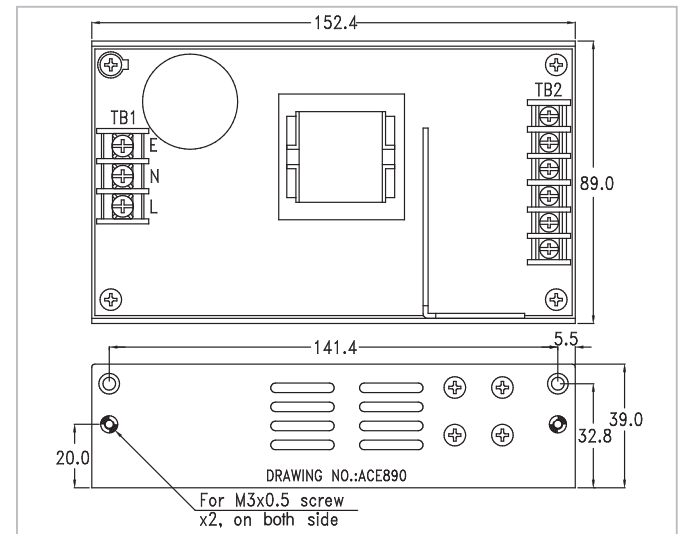

Input Type	18 ~ 36 VDC				
Output Voltage	+5 V	+12 V	-5 V	-12 V	+24 V
	10 A	2.5 A		0.5 A	
Efficiency	70%				
Temperature	0°C ~ 50°C (Operating), -20°C ~ 85°C (Storage)				
MTBF (hrs)	251,000 (ACE-890C), 265,000 (ACE-890P)				
Output Connector	Optional cable				
Dimensions (mm)	152.4 x 89 x 39				

Option 1	AT P8P9 Backplane Solution
	PN: CB-890P8P9-RS 30 cm DC cable AT power to P8P9, HDD and SATA connectors

Ordering Information

Part No.	Description
ACE-890C-RS	86W 24V DC Input Open Frame AT Power Supply

- Industrial Computing Solutions
- Video Capture Solutions
- Industrial Computer Chassis
- Open Frame Monitor
- Power Supply/ Peripherals
- All-in-One System

1U/2U Type Selection Guide

Safety (ITE Standard) - CB IEC 60950, UL 60950, CSA C 22.2 No. 60950, TUV EN 60950

Safety (Medical Standard) - CB IEC 60601, UL 60601, CSA C 22.2 No. 60601, TUV EN 60601

EMI - Meets EN 55022, FCC Part 15, CISPR 22

Meets EN 61000-3-2, EN 61000-3-3 (PFC function)

EMS - Meets EN 55024, EN 61000-4-2/3/4/5/6/8/11

* For detailed specs, please refer to official certification

1U AC Input

Products	Model No.	Watt ATX ATX PFC	Input Range Voltage	Output Current Range							Efficiency	ErP	Operating Temperature	Safety	Dimensions (mm)
				+3.3 V	+5 V	+12 V	-5 V	-12 V	+5 Vsb	+24 V					
	ACE-A630B	300W ATX -	90 ~ 265 VAC	16 A (0.5 A min.)	18 A (0.5 A min.)	15 A (0.5 A min.)		0.5 A	3 A		 82%	V	0°C ~ 50°C	CB/UL/ TUV/ CCC/ CE/FCC	150 x 81.5 x 40.5
	ACE-A627A	270W ATX PFC	90 ~ 264 VAC	16 A (0.5 A min.)	18 A (0.5 A min.)	V1: 16 A (1A) V2: 10A (1A)		0.8 A	2.5 A		 80%	V	0°C ~ 50°C	CB/UL/ TUV/ CCC/ CE/FCC	150 x 81 x 40
	ACE-A225A	250W ATX PFC	90 ~ 264 VAC	14 A (0.3 A)	16 A (0.3 A)	V1: 16 A (0.5 A) V2: 16 A (0.5 A)	0.3 A	0.5 A	3 A		 82%	V	-5°C ~ 50°C	CB/UL/ TUV/ CCC/ CE/FCC	190 x 100 x 40
	ACE-A622B	220W ATX -	90 ~ 264 VAC	10 A (0.1 A min.)	14 A (0.2 A min.)	14 A (0.6 A min.)		0.3 A	2.5 A		 85%	V	0°C ~ 50°C	CB/UL/ TUV/ CCC/ CE/FCC	150 x 81.5 x 40.5
	ACE-A622A	220W ATX PFC	90 ~ 264 VAC	14 A (0.5 A min.)	16 A (0.5 A min.)	V1: 16 A (1A) V2: 10 A (1A)		0.8 A	2.5 A		 80%	V	0°C ~ 50°C	CB/UL/ TUV/ CCC/ CE/FCC	150 x 81 x 40
	ACE-A618B	180W ATX -	90 ~ 264 VAC	10 A (0.1 A min.)	14 A (0.2 A min.)	10 A (0.6 A min.)		0.3 A	2.5 A		 85%	V	0°C ~ 50°C	CB/UL/ TUV/ CCC/ CE/FCC	150 x 81.5 x 40.5
	ACE-A618A	180W ATX PFC	90 ~ 264 VAC	14 A (0.3 A min.)	16 A (0.3 A min.)	14 A (1.5 A min.)		0.5 A	2 A		68%	V	0°C ~ 50°C	CB/UL/ TUV/ CCC/ CE/FCC	150 x 81 x 40
	ACE-A615B	150W ATX -	90 ~ 264 VAC	10 A (0.1 A min.)	14 A (0.2 A min.)	10 A (0.6 A min.)		0.3 A	2.5 A		 85%	V	0°C ~ 50°C	CB/UL/ TUV/ CCC/ CE/FCC	150 x 81.5 x 40.5

1

Industrial
Computing
Solutions

2

Video
Capture
Solutions

3

Industrial
Computer
Chassis

4

Open
Frame
Monitor

5

Power Supply/
Peripherals

6

All-in-One
System

1U/2U Type Selection Guide

Safety (ITE Standard) - CB IEC 60950, UL 60950, CSA C 22.2 No. 60950, TUV EN 60950

Safety (Medical Standard) - CB IEC 60601, UL 60601, CSA C 22.2 No. 60601, TUV EN 60601





EMI - Meets EN 55022, FCC Part 15, CISPR 22

Meets EN 61000-3-2, EN 61000-3-3 (PFC function)



EMS - Meets EN 55024, EN 61000-4-2/3/4/5/6/8/11

* For detailed specs, please refer to official certification

1U AC Input

Products	Model No.	Watt AT/ ATX PFC	Input Range Voltage	Output Current Range							Efficiency	ErP	Operating Temperature	Safety	Dimensions (mm)
				+3.3 V	+5 V	+12 V	-5 V	-12 V	+5 Vsb	+24 V					
	ACE-A615A	150W ATX PFC	90 ~ 264 VAC	10 A (0.3 A min.)	13 A (0.3 A min.)	10 A (1A min.)		0.5 A	2 A		68%	V	0°C ~ 50°C	CB/UL/ TUV/ CCC/ CE/FCC	150 x 81 x 40
	ACE-916AP	150W AT PFC	90 ~ 264 VAC		16 A (1 A min.)	6 A (0.5 A min.)		0.3 A			68%		0°C ~ 35°C	CB/UL/ TUV/ CCC/ NEMKO/ BSMI/ CE/FCC	150 x 81.5 x 40.5
	ACE-716A	150W AT -	85 ~ 135 VAC 180 ~ 265 VAC		18 A (1 A min.)	4 A	0.5 A	1 A			75%		-20°C ~ 70°C	UL	198 x 97 x 40.5
	ACE-716AP	150W AT PFC	85 ~ 265 VAC		18 A (1 A min.)	4 A	0.5 A	1 A			75%		-20°C ~ 70°C	UL TUV CE	198 x 97 x 40.5

1U DC Input

Products	Model No.	Watt AT/ ATX PFC	Input Range Voltage	Output Current Range							Efficiency	Operating Temperature	Safety	Dimensions (mm)	
				+3.3 V	+5 V	+12 V	-5 V	-12 V	+5 Vsb	+24V					
	ACE-717CX	170W ATX -	24 VDC (19 ~ 32 VDC)	6 A	8 A (1 A min.)	8 A (1 A min.)		0.5 A	1 A		75%		0°C ~ 70°C	CB UL TUV CCC CE	198 x 97 x 39
	ACE-4520C	200W ATX -	24 VDC (18 ~ 36 VDC)	12 A	12 A (1 A min.)	15.4 A (0.5 A min.)		0.5 A	2 A		78%		0°C ~ 50°C	CB UL TUV CCC NEMKO CE FCC	150 x 81.5 x 40.5
	ACE-716C	150W AT -	24 VDC (19 ~ 30 VDC)		18 A (2 A min.)	4 A	0.5 A	1 A			70%		-20°C ~ 70°C	UL TUV CE	198 x 97 x 40.5

2U AC Input

	ACE-D825A	252W AT PFC	90 ~ 264 VAC			15 A (0.1 A min.)				8 A	80%		0°C ~ 50°C	CB UL TUV CCC CE FCC	140 x 150 x 86
---	-----------	-------------	--------------	--	--	-------------------	--	--	--	-----	-----	--	------------	----------------------	----------------

1

Industrial Computing Solutions

2

Video Capture Solutions

3

Industrial Computer Chassis

4

Open Frame Monitor

5

Power Supply/ Peripherals

6

All-in-One System

1U AC Input ATX Type

ACE-A630B

1U Flex ATX 300 W Power Supply



Dimensions (Unit: mm)

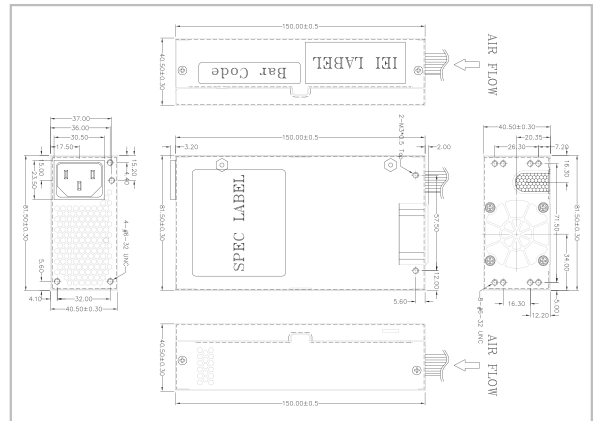

Specifications

Input Type	90~264VAC Full Range				
Output Voltage	+3.3 V	+5 V	+12 V	-12 V	+5 Vsb
	16 A (0.5 A min.)	18 A (0.5 A min.)	15 A (0.5 A min.)	0.5 A	3 A
Efficiency	82%				
Temperature	Operating: 0°C ~ 50°C, Storage: -20°C ~ 80°C				
MTBF (hrs)	100,000				
Output Connector	20+4-pin ATX, 4-pin 12V CPU, 1x FDD, 2 x HDD, 2 xSATA				
Dimensions (mm)	150 x 81.5 x 40.5				

Ordering Information

Part No.	Description
ACE-A630B-RS-R10	1U Flex ATX 300W Power Supply, 90~264 VAC, ErP, CCL, RoHS

ACE-A627A

270 W 1U Type ATX Power Supply



Dimensions (Unit: mm)

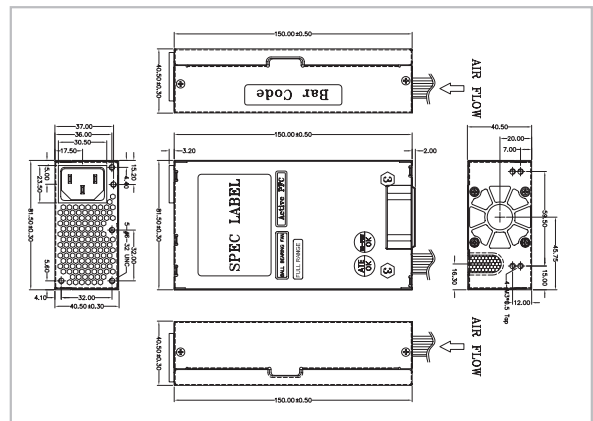

Specifications

Input Type	90~264 VAC Full Range					
Output Voltage	+3.3 V	+5 V	+12 V	+12 V 2	-12 V	+5 Vsb
	16 A (0.5 A min.)	18 A (0.5 A min.)	16 A (1 A min.)	10 A (1 A min.)	0.8 A (0 A min.)	2.5 A (0 A min.)
Efficiency	80%					
Temperature	Operating: 0°C ~ 50°C, Storage: -20°C ~ 80°C					
MTBF (hrs)	100,000					
Output Connector	20-pin ATX, 4-pin 12 V, FDD and three HDD					
Dimensions (mm)	150 x 81.5 x 40.5					

Ordering Information

Part No.	Description
ACE-A627A-RS-R11	270W AC-DC 1U flex ATX Power Supply, with PFC/ErP, meets 80 PLUS

1

Industrial Computing Solutions

2

Video Capture Solutions

3

Industrial Computer Chassis

4

Open Frame Monitor

5

Power Supply/Peripherals

6

All-in-One System

ACE-A225A

1U 250 W ATX Power Supply with ErP



Specifications

Input	Voltage	90~264 VAC Full Range		
	Frequency	47 Hz ~ 63 Hz		
	Input Current	4A (RMS)@115VAC, 2A (RMS)@230VAC		
	Inrush Current	50A max for 115VAC 100A max for 230VAC		
Output	Voltage	Min. load	Max. load	Ripple & Noise
	+3.3V	0.3 A	14 A	50mV
	+5V	0.3 A	16 A	50mV
	+12V1	0.5 A	16 A	120mV
	+12V2	0.5 A	16 A	120mV
	-12V	0 A	0.5 A	120mV
	+5VSB	0 A	3 A	50mV
	-5V	0 A	0.3 A	100mV
The +3.3V and +5V total output shall not exceed 110 watts.				
Total output for this power supply is 250 watts.				
Over Voltage Protection	+3.3V: 3.5V-4.8V			
	+5V: 5.5V-7V			
	+12V1 ~ +12V2: 13.4V-16V			
Short Circuit Protection	+3.3V, +5V, +12V shutdown and latch off			
General Specifications	Watt	250W		
	PFC	Active		
	Hold-up Time	17 ms min.		
	Efficiency	85%		
	MTBF	100,000 hours		
	Temperature	Operating: -5°C ~ 50°C Storage: -20°C ~ 80°C		
	Dimensions (mm)	100 x 190 x 40		
	Output Connector	20+4-pin ATX, 4-pin 12V, 4 x HDD, 2 x SATA, 1 x FDD		

Dimensions (Unit: mm)

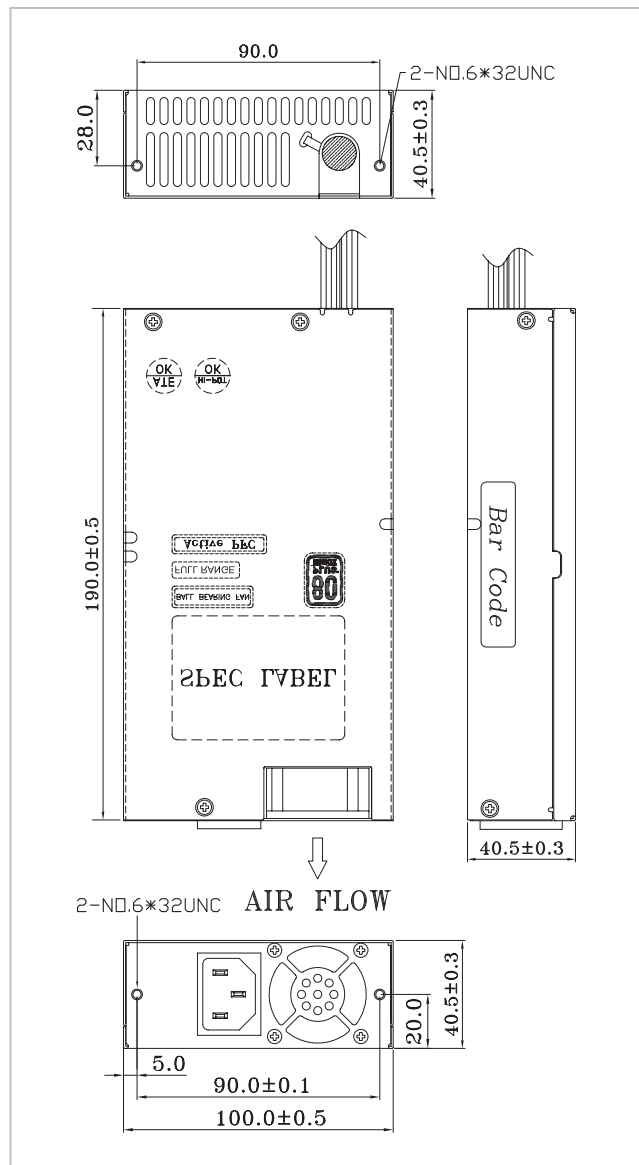

Ordering Information

Part No.	Description
ACE-A225A-R11	250W AC-DC 1U ATX Power Supply with ErP, meets 80 PLUS (Bronze)

1

Industrial Computing Solutions

2

Video Capture Solutions

3

Industrial Computer Chassis

4

Open Frame Monitor

5

Power Supply/ Peripherals

6

All-in-One System

ACE-A622A/B 220 W 1U Type ATX Power Supply



Dimensions (Unit: mm)

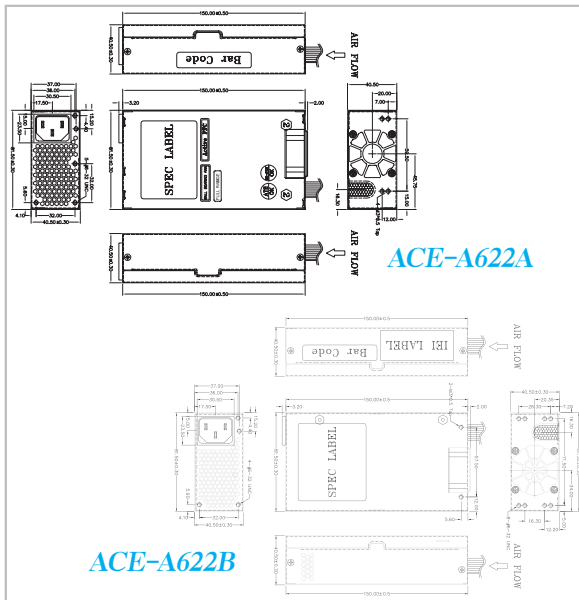

Specifications

Input Type	90~264 VAC Full Range					
Output Voltage	+3.3 V	+5 V	+12 V	+12 V 2	-12 V	+5 Vsb
	ACE-A622A	14 A (0.5 A min.)	16 A (0.5 A min.)	16 A (1 A min.)	10 A (1 A min.)	0.8 A (0 A min.)
ACE-A622B	10 A (0.1 A min.)	14 A (0.2 A min.)	14 A (0.6 A min.)		0.3 A	2.5 A
Efficiency	ACE-A622A: 80% / ACE-A622B: 85%					
Temperature	Operating: 0°C ~ 50°C, Storage: -20°C ~ 80°C					
MTBF (hrs)	100,000					
Output Connector	ACE-A622A: 20-pin ATX, 4-pin 12 V, 3 x HDD, 1 x FDD ACE-A622B: 20+4-pin ATX, 4-pin 12V CPU, 1 x FDD, 2 x HDD, 2 xSATA					
Dimensions (mm)	150 x 81.5 x 40.5					

Ordering Information

Part No.	Description
ACE-A622A-RS-R11	220W AC-DC 1U Flex ATX Power Supply, with PFC/ErP, meets 80 PLUS
ACE-A622B-RS-R10	1U Flex ATX 220W Power Supply, 90~264VAC, ErP, CCL, RoHS

ACE-A618A/B 180 W 1U Type ATX Power Supply



Dimensions (Unit: mm)

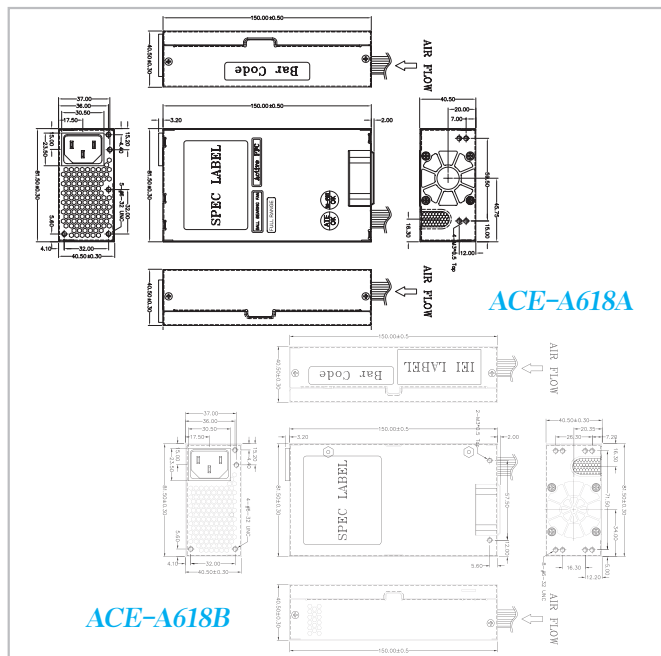

Specifications

Input Type	90~264 VAC Full Range				
Output Voltage	+3.3 V	+5 V	+12 V	-12 V	+5 Vsb
	ACE-A618A	14 A (0.3 A min.)	16 A (0.3 A min.)	14 A (1.5 A min.)	0.5 A (0 A min.)
ACE-A618B	10 A (0.1 A min.)	14 A (0.2 A min.)	10 A (0.6 A min.)	0.3 A	2.5 A
Efficiency	ACE-A618A: 68% / ACE-A618B: 85%				
Temperature	Operating: 0°C ~ 50°C, Storage: -20°C ~ 80°C				
MTBF (hrs)	100,000				
Output Connector	ACE-A618A: 20-pin ATX, 4-pin 12 V, 3 x HDD, 1 x FDD ACE-A618B: 20+4-pin ATX, 4-pin 12V CPU, 1 x FDD, 2 x HDD, 2 xSATA				
Dimensions (mm)	150 x 81.5 x 40.5				

Ordering Information

Part No.	Description
ACE-A618A-RS-R11	180W AC-DC 1U Flex ATX Power Supply, with PFC/ErP
ACE-A618B-RS-R10	1U Flex ATX 180W Power Supply, 90~264VAC, ErP, CCL, RoHS

1

Industrial Computing Solutions

2

Video Capture Solutions

3

Industrial Computer Chassis

4

Open Frame Monitor

5

Power Supply/ Peripherals

6

All-in-One System

ACE-A615A/B 150 W 1U Type ATX Power Supply



Dimensions (Unit: mm)

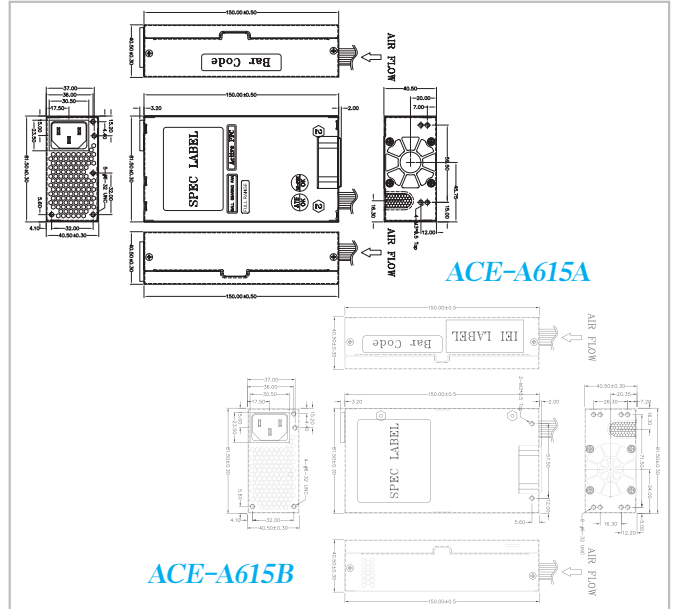

Specifications

Input Type	90~264 VAC Full Range					
Output Voltage		+3.3 V	+5 V	+12 V	-12 V	+5 Vsb
	ACE-A615A	10 A (0.3 A min.)	13 A (0.3 A min.)	10 A (1 A min.)	0.5 A (0 A min.)	2.0 A (0 A min.)
	ACE-A615B	10 A (0.1 A min.)	14 A (0.2 A min.)	10 A (0.6 A min.)	0.3 A	2.5 A
Efficiency	ACE-A615A: 68% / ACE-A615B: 85%					
Temperature	Operating: 0°C ~ 50°C, Storage: -20°C ~ 80°C					
MTBF (hrs)	100,000					
Output Connector	ACE-A615A	20-pin ATX, 4-pin 12 V CPU, FDD, 3 x HDD				
	ACE-A615B	20+4-pin ATX, 4-pin 12V CPU, 1 x FDD, 2 x HDD, 2 x SATA				
Dimensions (mm)	150 x 81.5 x 40.5					

Ordering Information

Part No.	Description
ACE-A615A-RS-R11	150W AC-DC 1U Flex ATX Power Supply, with PFC/ErP
ACE-A615B-RS-R10	1U Flex ATX 150W Power Supply, 90~264VAC, ErP, CCL, RoHS

1 Industrial Computing Solutions

1U AC Input AT Type

2 Video Capture Solutions

ACE-916AP 150 W 1U Type AT Power Supply



3 Industrial Computer Chassis



4 Open Frame Monitor

Dimensions (Unit: mm)

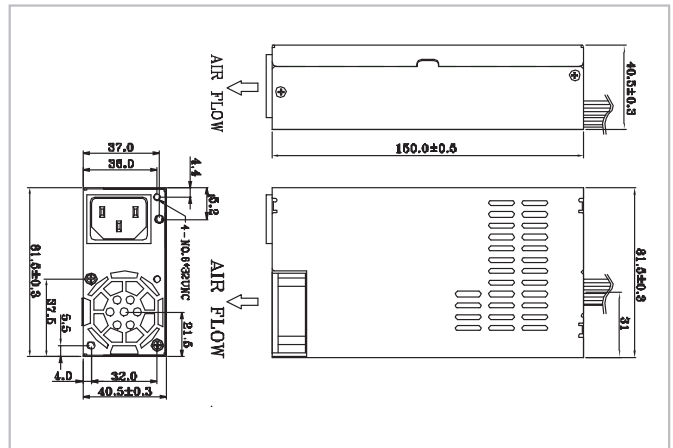

5 Power Supply/Peripherals

Specifications

Input Type	90 ~ 264 VAC Full Range				
Output Voltage	+5V	+12V	-5V	-12V	+24V
	16 A (1 A min.)	6 A (0.5 A min.)		0.3 A	
Efficiency	68%				
Temperature	0°C ~ 50°C (Operating), -20°C ~ 80°C (Storage)				
MTBF (hrs)	100,000				
Output Connector	P8P9, FDD, 3 x HDD				
Dimensions (mm)	150 x 81.5 x 40.5				

6 All-in-One System

Ordering Information

Part No.	Description
ACE-916AP-RS	150W AC-DC AT Power Supply, with PFC

ACE-716A/AP

150 W 1U Type AT Power Supply



Specifications

Input Type	85 ~ 135 VAC, 180 ~ 265 VAC Auto Range (ACE-716A) 85 ~ 265 VAC Full Range (ACE-716AP)			
Output Voltage	+5V 18 A (1 A min.)	+12V 4 A	-5V 0.5 A	-12V 1 A
Efficiency	75%			
Temperature	Operating: -20°C ~ 70°C (50°C ~ 70°C derating curve) Storage: -20°C ~ 85°C			
MTBF (hrs)	149,000			
Output Connector	Optional cable			
Dimensions (mm)	198 x 97 x 40.5			

Ordering Information

Part No.	Description
ACE-716A-RS	150W AC-DC AT Power Supply
ACE-716AP-RS	150W AC-DC AT Power Supply, with PFC

Dimensions (Unit: mm)

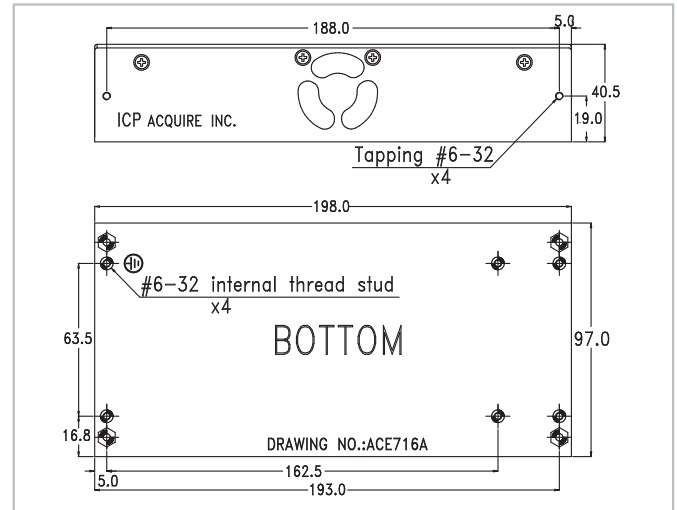

Option 1 Embedded Solution



PN: CB-716EB-RS
30 cm DC cable to CPU card with 4-pin 12 V CPU, HDD and SATA connectors

Option 2 AT P8P9 Backplane Solution



PN: CB-716P8P9-RS
30 cm DC cable AT power to P8P9 with HDD and SATA connectors

1U DC Input ATX Type

ACE-717CX

1U 24V DC Input ATX Power Supply



Specifications

Input Type	19 ~ -32 VDC					
Output Voltage	+3.3V 6 A	+5V 8 A (1 A min.)	+12V 8 A (1 A min.)	-5V 0.5 A	-12V 0.5 A	+5Vsb 1 A
Efficiency	75%					
Temperature	Operating: 0°C ~ 70°C (can be started up at -20°C) Storage: -40°C ~ 75°C					
MTBF (hrs)	100,000					
Output Connector	5VSB & PS_ON cable					
Dimensions (mm)	198 x 97 x 39					

Option 1 ATX Backplane Solution



PN: CB-717BP-RS
30 cm DC cable for ACE-715VX/717CX power to backplane, with 20-pin ATX, HDD and SATA connector

Dimensions (Unit: mm)

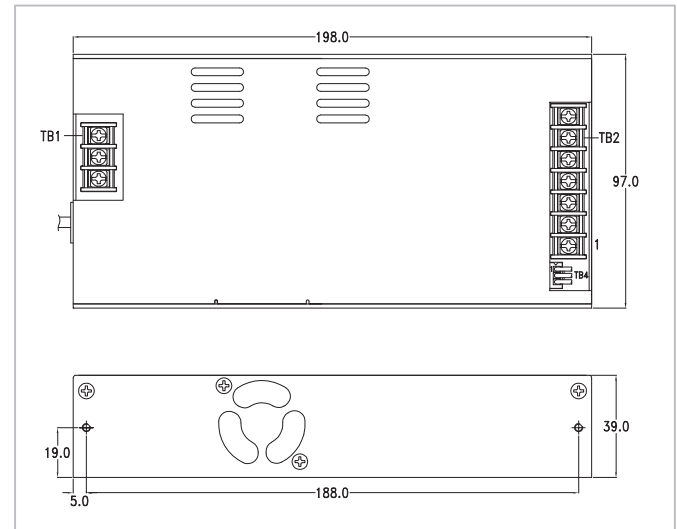

Ordering Information

Part No.	Description
ACE-717CX-RS	170W 24V DC input ATX Power Supply

1 Industrial Computing Solutions

2 Video Capture Solutions

3 Industrial Computer Chassis

4 Open Frame Monitor

5 Power Supply/ Peripherals

6 All-in-One System

ACE-4520C

200 W 24V DC input 1U ATX Power Supply

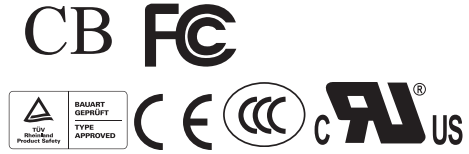

High power capacity 200W in 1U size!!
Meets ATX revision 2.0 with 20+4-pin ATX power and SATA

Features

1. High efficiency
2. Low ripple & noise
3. Output overvoltage protection
4. Short circuit protection on all output
5. 100% burn-in under high ambient temperature (50°C)
6. Vacuum-impregnated transformer
7. MTBF: 100K hours at 25°C
8. 100% hi-pot tested
9. Line input fuse protection

PICMG 1.0 Form Factor Backplane

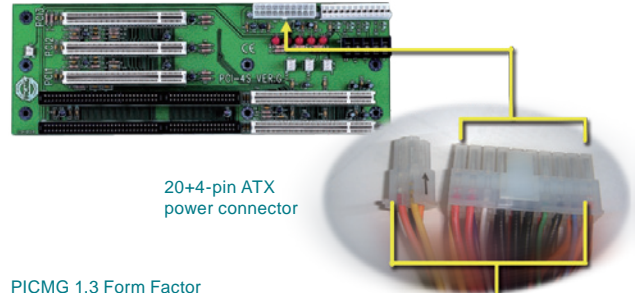

20+4-pin ATX power connector

PICMG 1.3 Form Factor Backplane PE-10S/6S

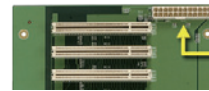

Specifications

Input	Voltage	18 ~ 36 VDC input			
	Input Current	15 A (RMS) @ -24 VDC			
	Inrush Current	100 A max. for -24 VDC			
Output	Voltage	Min. Load	Max. Load	Ripple & Noise	
	+5 V	1 A	12 A	50 mV P-P	
	+12 V	0.5 A	15.4 A	120 mV P-P	
	-12 V	0 A	0.5 A	120 mV P-P	
	+3.3 V	0 A	12 A	50 mV P-P	
	+5 Vsb	0 A	2 A	50 mV P-P	
	+3.3V, +5V, +12V total current not exceed 184W				
	Overvoltage Protection	+5 V output: 5.7 V ~ 6.5 V +12 V output: 13.1 V ~ 14.5 V +3.3 V output: 3.7 V ~ 4.1 V			
	Over Circuit Protection	+5 V output: 13.2 V ~ 18 V +12 V output: 17.6 V ~ 24 V +3.3 V output: 13.2 V ~ 18 V			
	Short Circuit Protection	+3.3 V, +5 V, +12 V shut down and latch off			
General Specifications	Output Rise Time	20 ms max.			
	Efficiency	78%			
	MTBF	100,000 hours on max. load at +25°C			
	Temperature	Operating: 0°C ~ 50°C Storage: -20°C ~ 80°C			
	Relative Humidity	5% ~ 95% RH non-condensing			
	Output Connector	20+4-pin ATX, 4-pin 12 V CPU, FDD, SATA, 2 x HDD			

Dimensions (Unit: mm)

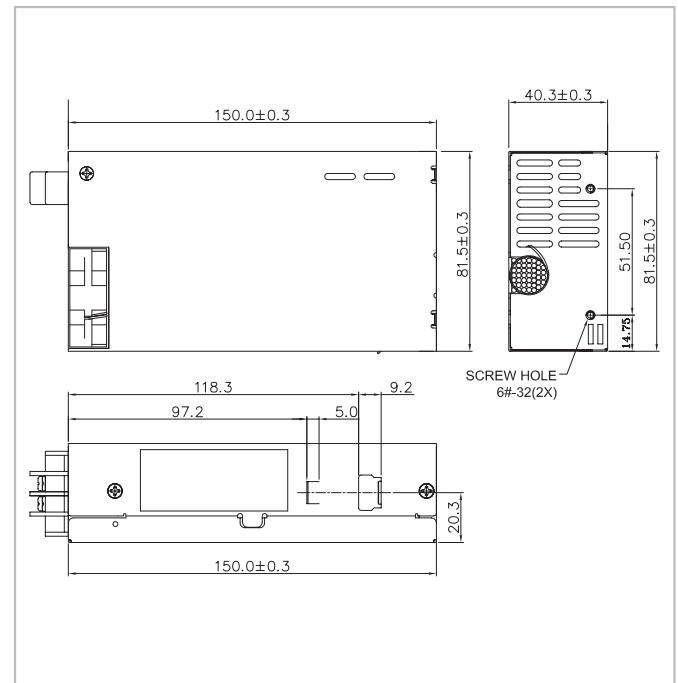

Ordering Information

Part No.	Description
ACE-4520C-RS	200W 24 V DC Input 1U ATX Power Supply

1

Industrial Computing Solutions

2

Video Capture Solutions

3

Industrial Computer Chassis

4

Open Frame Monitor

5

Power Supply/ Peripherals

6

All-in-One System

ACE-716C

150 W 24V DC Input AT Power Supply



Input Type	19 ~ 30 VDC				
Output Voltage	+5 V	+12 V	-5 V	-12 V	+24 V
	18 A (2 A min.)	4 A	0.5 A	1 A	
Efficiency	70%				
Temperature	Operating: -20°C ~ 70°C (50°C ~ 70°C derating curve) Storage: -20°C ~ 85°C				
MTBF (hrs)	210,000				
Output Connector	Optional cable				
Dimensions (mm)	198 x 97 x 40.5				

Dimensions (Unit: mm)

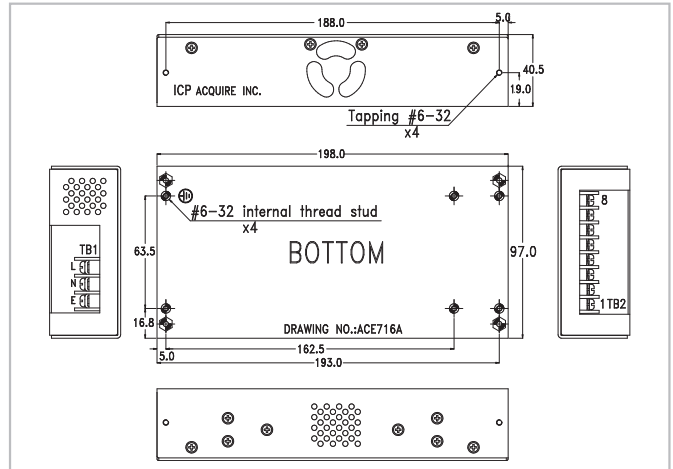

Output terminal block connectors

Pin 1, 2	Pin 3, 4	Pin 5	Pin 6	Pin 7	Pin 8
5 V	GND	-5 V	-12 V	GND	+12 V

Ordering Information

Part No.	Description
ACE-716C-RS	150 W 24 V DC Input AT Power Supply

Option 1	Embedded Solution	Option 2	AT P8P9 Backplane Solution
	PN: CB-716EB-RS 30 cm DC cable to CPU card with 4-pin 12 V CPU, HDD and SATA connectors		PN: CB-716P8P9-RS 30 cm DC cable AT power to P8P9 with HDD and SATA connectors

2U AC Input ATX Type

ACE-D825A

252 W Flex Power Supply



ACE-D825A-H:
Rubber sleeve exterior is ideal for desktop applications, such as AC-DC power adaptor.

ACE-D825A

Specifications

Input Type	90~264 VAC Full Range	
Output Voltage	+12 V	+24 V
	15 A (1 A min.)	3 A (0 A min.), peak load 8 A
Efficiency	80%	
Temperature	Operating: 0°C ~ 50°C Storage: -20°C ~ 80°C	
MTBF (hrs)	100,000	
Output Connector	1 x 5-pin molex 39-01-2100 1 x 4-pin power mini-DIN for +12 V 1 x 3-pin power mini-DIN for +24 VDC	
Dimensions (mm)	140 x 150 x 86	

Dimensions (Unit: mm)

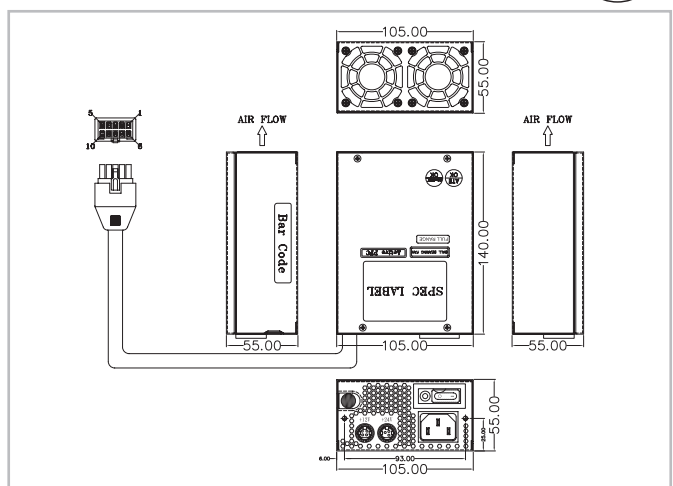

Output Pin Definitions

GND	GND	GND		5	6	7	8	9	10
COM	COM	COM	COM	+24V	+12V	+12V	+12V	+12V	+24V
				+24Vs	+12Vs				

Ordering Information

Part No.	Description
ACE-D825A-RS	252W Flex Power Supply
ACE-D825A-H-RS	252W Flex Power Supply, with rubber sleeve

- 1 Industrial Computing Solutions
- 2 Video Capture Solutions
- 3 Industrial Computer Chassis
- 4 Open Frame Monitor
- 5 Power Supply/Peripherals
- 6 All-in-One System

PS/2 Selection Guide

Safety (ITE Standard) - CB IEC 60950, UL 60950, CSA C 22.2 No. 60950, TUV EN 60950

Safety (Medical Standard) - CB IEC 60601, UL 60601, CSA C 22.2 No. 60601, TUV EN 60601

EMI - Meets EN 55022, FCC Part 15, CISPR 22

Meets EN 61000-3-2, EN 61000-3-3 (PFC function)

EMS - Meets EN 55024, EN 61000-4-2/3/4/5/6/8/11

* For detailed specs, please refer to official certification

AC Input

Product	Model No.	Watt AT/ATX PFC	Input Range Voltage	Output Current Range						Efficiency	ErP	Operating Temperature	Safety
				+3.3 V	+5 V	+12 V	-5 V	-12 V	+5 Vsb				
	ACE-A160A	600W ATX PFC	90-264 VAC	25 A (1.5 A)	25 A (1 A)	V1: 16 A (1 A) V2: 16 A (1 A) V3: 16 A (1 A) V4: 16 A (0.5 A)	0.5 A	4 A	 85%	v	-5°C ~ 50°C	CB / UL / TUV CCC / CE / FCC	
	Medical ACE-4840APM	400W ATX PFC	90 ~ 265 VAC	30 A (0.5 A min.)	30 A (0.3 A min.)	V1: 17 A (1 A min.) V2: 17 A (1 A min.)	0.3 A	0.8 A	2 A	68%		0°C ~ 50°C	CB / UL CCC / VDE
	ACE-A140A	400W ATX PFC	90 ~ 264 VAC	21 A (0.1 A)	20 A (0.2 A)	V1: 16 A (0.1 A) V2: 16 A (0.5 A)	0.3 A	0.5 A	3 A	 85%	v	-5°C ~ 50°C	CB / UL / TUV CCC / CE / FCC
	ACE-A130B	300W ATX PFC	90 ~ 264 VAC	19 A (0.3 A)	16 A (0.5 A)	V1: 17 A (0.5 A) V2: 17 A (0.5 A)	0.2 A	0.3 A	3 A (0.1 A)	 85%	v	-5°C ~ 50°C	CB / UL / TUV CCC / CE / FCC
	ACE-828A	280W ATX -	90 ~ 130 VAC 180 ~ 260 VAC	8 A	25 A (2 A min.)	10 A (0.1 A min.)	0.5 A	0.5 A	0.72 A	65%		-20°C ~ 70°C	CSA / TUV / CE
	Medical ACE-828M	280W ATX -	90 ~ 130 VAC 180 ~ 260 VAC	8 A	25 A (2 A min.)	10 A (0.1 A min.)	0.5 A	0.5 A	0.72 A	65%		-20°C ~ 70°C	UL / TUV / CE
	ACE-T140A	400W AT PFC	95 ~ 264 VAC		42 A (2 A min.)	15 A (1 A min.)	0.3 A	0.8 A		75%		0°C ~ 50°C	CB / UL / TUV CCC / CE / FCC
	ACE-932A	300W AT -	85 ~ 130 VAC 180 ~ 265 VAC		33 A (3 A min.)	8 A (0.1 A min.)	0.5 A	3 A		68%		-20°C ~ 70°C	UL / CSA
	ACE-925A	200W AT -	85 ~ 265 VAC		22 A (1 A min.)	7 A (0.1 A min.)	0.5 A	0.7 A		68%		0°C ~ 50°C	UL
	ACE-935AL	300W AT -	85 ~ 140 VAC 170 ~ 270 VAC		40 A (3 A min.)	8 A (0.1 A min.)	0.3 A	0.7 A		68%		0°C ~ 50°C	UL / CE
	ACE-925AP-U	250W AT PFC	90 ~ 265 VAC		22 A (1 A min.)	11 A (1 A min.)	0.5 A	0.7 A		70%		0°C ~ 50°C	CB / UL / TUV CCC / CE

DC Input

	ACE-828C	250W ATX -	24 VDC (18 ~ 32 VDC)	8 A	25 A (2 A min.)	7 A (0.1 A min.)	0.5 A	1 A	0.72 A	65%		0°C ~ 50°C	CB / CSA TUV / CCC CE
---	-----------------	------------------	-------------------------	-----	--------------------	---------------------	-------	-----	--------	-----	--	------------	-----------------------------

1

Industrial
Computing
Solutions

2

Video
Capture
Solutions

3

Industrial
Computer
Chassis

4

Open
Frame
Monitor

5

Power Supply/
Peripherals

6

All-in-One
System

PS/2 AC Input ATX Type

ACE-A160A

600W PS/2 ATX Power Supply with ErP

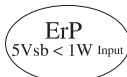

Ordering Information

Part No.	Description
ACE-A160A-R11	600W AC-DC PS/2 ATX Power Supply with ErP, meets 80 PLUS (Bronze)

Dimensions (Unit: mm)

REF. ID.	PIN NO.	SIGNAL	WIRE COLOR	CABLE LENGTH
P1 24	1	+3.3VDC	ORANGE	400±15mm
	2	+3.3VDC	ORANGE	
	3	COM	BLACK	
	4	+5VDC	RED	
	5	COM	BLACK	
	6	+5VDC	RED	
	7	COM	BLACK	
	8	PW-OK	GRAY	
	9	+5Vsb	PURPLE	
	10	+12V3	Yel/Blue	
	11	+12V3	Yel/Blue	
	12	+3.3VDC	ORANGE	
	13	+3.3VDC	ORANGE	
	14	+3.3V _{sense}	BROWN	
	15	+12VDC	BLUE	
	16	COM	BLACK	
	17	PS-ON	GREEN	
	18	COM	BLACK	
	19	COM	BLACK	
	20	-5V	WHITE	
	21	+5VDC	RED	
	22	+5VDC	RED	
	23	+5VDC	RED	
	24	COM	BLACK	
P2	1	COM	BLACK	400±15mm
	2	COM	BLACK	
	3	COM	BLACK	
	4	+5VDC	RED	
P3	1	COM	BLACK	500±15mm
	2	COM	BLACK	
	3	+12V1	YELLOW	
	4	+12V1	YELLOW	
PA	1	+3.3VDC	ORANGE	400±15mm
	2	COM	BLACK	
	3	+5V	RED	
	4	COM	BLACK	
	5	+12V3	Yel/Blue	
PB	1	+3.3VDC	ORANGE	155±10mm
	2	COM	BLACK	
	3	+5V	RED	
	4	COM	BLACK	
	5	+12V3	Yel/Blue	
PI	1	+12V4	Yel/White	400±15mm
	2	COM	BLACK	
	3	COM	BLACK	
	4	+5V	RED	
PJ	1	+12V4	Yel/White	155±10mm
	2	COM	BLACK	
	3	COM	BLACK	
PK	1	+5V	RED	150±10mm
	2	COM	BLACK	
	3	COM	BLACK	
	4	+12V4	Yel/White	
PC	1	+12V2	Yel/Black	400±15mm
	2	COM	BLACK	
	3	COM	BLACK	
	4	+5V	RED	
PD	1	+12V2	Yel/Black	155±10mm
	2	COM	BLACK	
	3	COM	BLACK	
	4	+5V	RED	
PE	1	+5V	RED	150±10mm
	2	COM	BLACK	
	3	COM	BLACK	
	4	+12V2	Yel/Black	

Specifications

Input	Voltage	90~265 VAC Full Range		
	Frequency	47 Hz ~ 63 Hz		
	Input Current	10A (RMS)@115VAC, 5A (RMS)@230VAC		
	Inrush Current	40A max. for 115VAC 80A max. for 230VAC		
Output	Voltage	Min. load	Max. load	Ripple & Noise
	+3.3V	1.5 A	25 A	50mV
	+5V	1 A	25 A	50mV
	+12V1	1 A	16 A	120mV
	+12V2	1 A	16 A	120mV
	+12V3	1 A	16 A	120mV
	+12V4	0.5 A	16 A	120mV
	-12V	0 A	0.5 A	120mV
	+5VSB	0 A	4.0 A	50mV
	Maximum continuous combined load on +3.3VDC and +5VDC outputs shall not exceed 150W.			
Maximum continuous total DC output power should not exceed 600W				
General Specifications	Over Voltage Protection	5V: 5.7V-6.5V 12V1 ~ 12V4: 13.3V-16.7V 3.3V: 3.9V-4.5V		
	Short Circuit Protection	+3.3V, +5V, +12V1, +12V2, +12V3, +12V4, 24V or -12V shutdown and latch off		
Watt	600W			
PFC	Active			
Hold-up Time	16 ms min.			
Efficiency	85%			
MTBF	100,000 hours			
Temperature	Operating: -5°C ~ 50°C Storage: -40°C ~ 80°C			
Dimensions (mm)	140 x 150 x 86			
Output Connector	1 x 20+4-pin ATX, 1 x 4-pin 12V CPU, 9 x HDD/CDROM, 2 x FDD, 2 x SATA, 1 x Extra +5V (P10)			

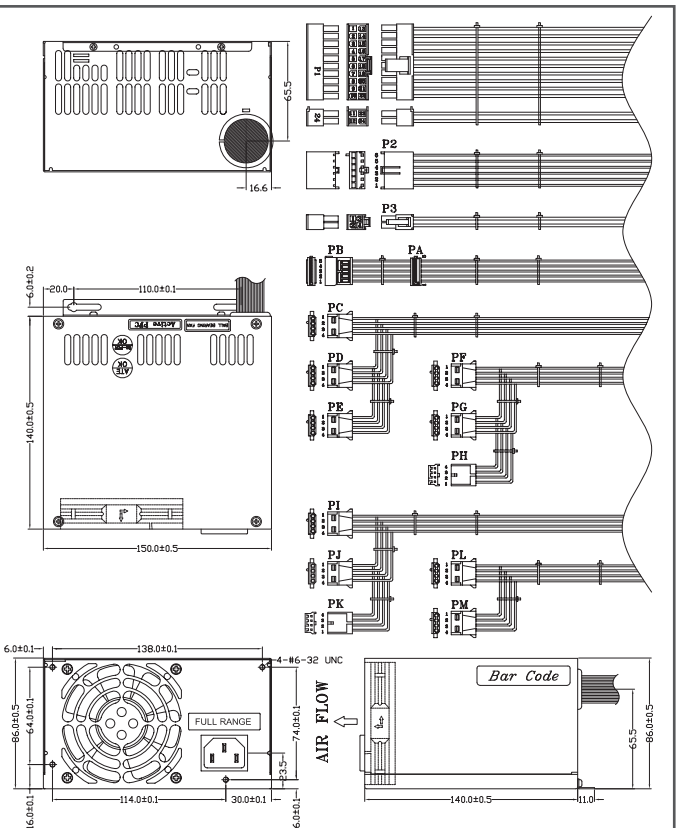

- 1 Industrial Computing Solutions
- 2 Video Capture Solutions
- 3 Industrial Computer Chassis
- 4 Open Frame Monitor
- 5 Power Supply/Peripherals
- 6 All-in-One System

ACE-4840APM

400 W PS/2 Medical Type ATX Power Supply



Medical



New Version 20+4 Pins Power Supply



Features

1. Internal 8 cm fan
2. Meets medical safety standards
3. Line input fuse protection
4. Output overvoltage protection
5. Short circuit protection on all outputs
6. Total +12 V output up to 34 A

PICMG 1.0 Form Factor Backplane

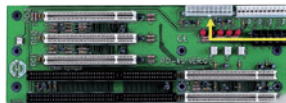

20+4-pin ATX power connector

PICMG 1.3 Form Factor Backplane PE-10S/6S



Specifications

Input Voltage	90 ~ 265 VAC Full Range			
Input Frequency	47 Hz ~ 63 Hz			
Input Current	8 A (RMS) for 115 VAC, 4 A (RMS) for 230 VAC			
Inrush Current	60 A max. for 115 VAC, 100 A max. for 230 VAC			
Output Voltage	Voltage	Min. load	Max. load	Ripple & Noise
	+3.3 V	0.5 A min	30 A	50 mV
	+5 V	0.3 A min	30 A	50 mV
	+12 V1	1 A min	17 A	120 mV
	+12 V2	1 A min	17 A	120 mV
	-5 V		0.3 A	100 mV
	-12 V		0.8 A	120 mV
+5 V sb		2 A	50 mV	
+3.3 V & +5 V total output not exceed 180 W +3.3 V & +5 V & +12 V total output not exceed 380 W				
Overvoltage Protection	+5 V +3.3 V +12 V	5.7 V ~ 6.5 V 3.7 V ~ 4.5 V 13.3 V ~ 15.6 V		
Hold Up Time	20 ms min.			
MTBF	100,000 hours			
Operating Temperature	0°C ~ 50°C			
Storage Temperature	-20°C ~ 80°C			
Efficiency	68%			
Dimensions (mm)	140 x 150 x 86			
Output Connector	1 x 20+4-pin ATX, 1 x 4-pin 12V CPU, 5 x HDD/CDROM, 2 x FDD, 2 x SATA, 1 x Extra +5V (P10)			

Ordering Information

Part No.	Description
ACE-4840APM-RS	400 W AC-DC PS/2 ATX Power Supply, meets medical standard, with PFC

Power Connector + 12 V

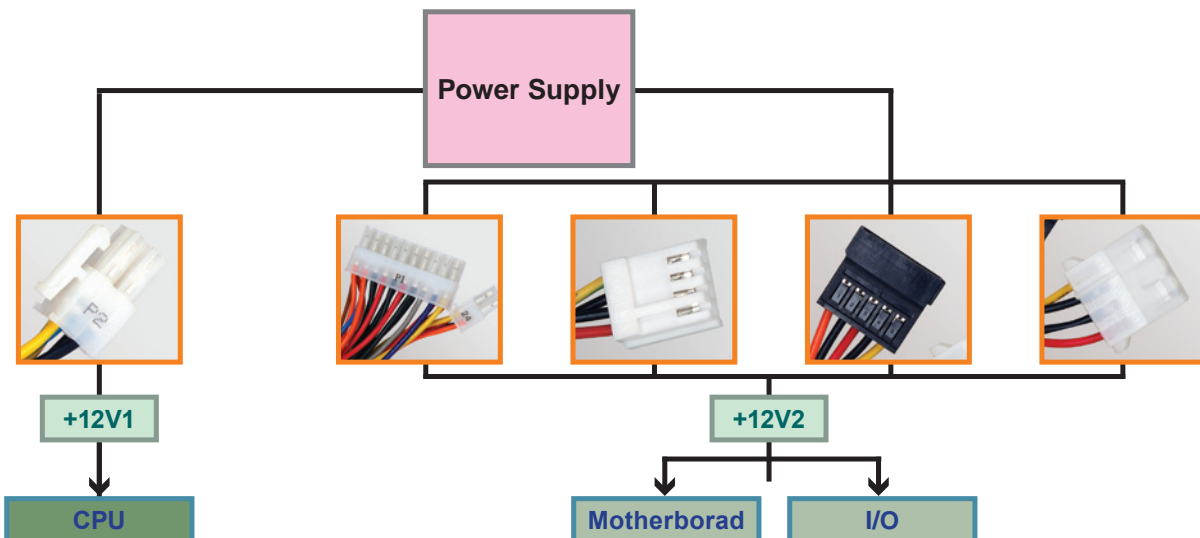

1

Industrial Computing Solutions

2

Video Capture Solutions

3

Industrial Computer Chassis

4

Open Frame Monitor

5

Power Supply/ Peripherals

6

All-in-One System

ACE-A140A

400 W PS/2 ATX Power Supply with ErP

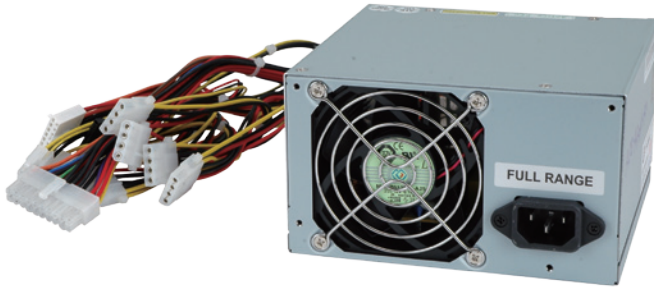

Specifications

Input	Voltage	90-264 VAC Full Range		
	Frequency	47 Hz ~ 63 Hz		
	Input Current	6A (RMS)@115VAC, 3A (RMS)@230VAC		
	Inrush Current	65A max. for 115VAC 147A max. for 230VAC		
Output	Voltage	Min. load	Max. load	Ripple & Noise
	+3.3V	0.1 A	21 A	50mV
	+5V	0.2 A	20 A	50mV
	+12V1	0.1 A	16 A	120mV
	+12V2	0.5 A	16 A	120mV
	-12V	0 A	0.5 A	120mV
	-5V	0 A	0.3 A	50mV
	+5VSB	0 A	3 A	50mV

The +3.3V and +5V total output shall not exceed 130 watts.
Total output for this power supply is 400 watts.

General Specifications	Over Voltage Protection	+3.3V: 3.5V-4.5V +5V: 5.5V-6.82V +12V1 and +12V2: 13.4V-15.6V
	Short Circuit Protection	+3.3V, +5V, +12V or -12V shutdown and latch off
	Watt	400W
	PFC	Active
	Hold-up Time	17 ms Min.
	Efficiency	85%
	MTBF	100000 hours
	Temperature	Operating: -5°C ~ 50°C Storage: -20°C ~ 80°C
	Dimensions (mm)	140 x 150 x 86
	Output Connector	1 x 20+4-PIN ATX, 1 x 4-pin 12V CPU, 8 x HDD/CDROM, 2 x FDD, 1 x Extra +5V (P10)

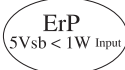

Ordering Information

Part No.	Description
ACE-A140A-R11	400W AC-DC PS/2 ATX Power Supply with ErP, meets 80 PLUS (Bronze)

Dimensions (Unit: mm)

REF. ID.	PIN NO.	SIGNAL	WIRE COLOR	GAUGE	CONNECTOR TYPE	CABLE LENGTH
P1 24	1	+3.3VDC	ORANGE	18	WST P80 14002K11D+P4 14002K11D or EQUIV.	600±15mm
	2	+3.3VDC	ORANGE	18		
	3	COM	BLACK	18		
	4	+5VDC	RED	18		
	5	COM	BLACK	18		
	6	+5VDC	RED	18		
	7	COM	BLACK	18		
	8	PW-OK	GRAY	22		
	9	+5Vsb	PURPLE	18		
	10	+12V2	YELLOW	18		
	11	+12V1	YELLOW	18		
	12	+3.3VDC	ORANGE	18		
	13	+3.3VDC	ORANGE	18		
	14	+3.3Vsb	BROWN	22		
	15	-12VDC	BLUE	18		
	16	COM	BLACK	18		
	17	PS-ON	GREEN	22		
	18	COM	BLACK	18		
	19	COM	BLACK	18		
	20	-5V	WHITE	22		
	21	+5VDC	RED	18		
	22	+5VDC	RED	18		
	23	+5VDC	RED	18		
	24	COM	BLACK	18		
P2	1	COM	BLACK	18	MOLEX 90331-0010 or EQUIV.	500±15mm
	2	COM	BLACK	18		
	3	COM	BLACK	18		
	4	+3.3VDC	ORANGE	18		
P3	1	COM	BLACK	18	MOLEX 39-01-2040 or EQUIV.	500±15mm
	2	COM	BLACK	18		
	3	+12V1	Yel/Black	18		
PA	1	+12V1	Yel/Black	18	AMP 1-480424-0 or EQUIV.	400±15mm
	2	COM	BLACK	18		
PB	1	+12V2	YELLOW	18	AMP 1-480424-0 or EQUIV.	200±10mm
	2	COM	BLACK	18		
PC	1	+12V2	YELLOW	18	AMP 1-480424-0 or EQUIV.	200±10mm
	2	COM	BLACK	18		
PD	1	+5V	RED	18	AMP 171822-4 or EQUIV.	200±10mm
	2	COM	BLACK	20		
PE	1	+12V1	Yel/Black	20	AMP 1-480424-0 or EQUIV.	400±15mm
	2	COM	BLACK	20		
PF	1	+12V2	YELLOW	20	AMP 1-480424-0 or EQUIV.	200±10mm
	2	COM	BLACK	20		
PG	1	+5V	RED	22	AMP 171822-4 or EQUIV.	200±10mm
	2	COM	BLACK	22		
PH	1	+12V1	Yel/Black	20	AMP 1-480424-0 or EQUIV.	400±15mm
	2	COM	BLACK	20		
PI	1	+12V1	Yel/Black	20	AMP 1-480424-0 or EQUIV.	200±10mm
	2	COM	BLACK	20		
PJ	1	+5V	RED	22	AMP 171822-4 or EQUIV.	200±10mm
	2	COM	BLACK	22		
PK	1	+12V1	Yel/Black	20	MOLEX SD-67926-0311 or EQUIV.	400±15mm
	2	COM	BLACK	20		
PL	1	+3.3VDC	ORANGE	20	MOLEX SD-67582-0011 or EQUIV.	155±10mm
	2	COM	BLACK	20		
PL	3	+5V	RED	20		
	4	COM	BLACK	20		
	5	+12V1	Yel/Black	20		

- 1 Industrial Computing Solutions
- 2 Video Capture Solutions
- 3 Industrial Computer Chassis
- 4 Open Frame Monitor
- 5 Power Supply/Peripherals
- 6 All-in-One System

ACE-A140A-S

400 W PS/2 ATX Power Supply with ErP



Specifications

Input	Voltage	90-264 VAC Full Range		
	Frequency	47 Hz ~ 63 Hz		
	Input Current	6A (RMS)@115VAC, 3A (RMS)@230VAC		
	Inrush Current	65A max. for 115VAC 147A max. for 230VAC		
Output	Voltage	Min. load	Max. load	Ripple & Noise
	+3.3V	0.1 A	21 A	50mV
	+5V	0.2 A	20 A	50mV
	+12V1	0.1 A	16 A	120mV
	+12V2	0.5 A	16 A	120mV
	-12V	0 A	0.5 A	120mV
	-5V	0 A	0.3 A	50mV
	+5VSB	0 A	3 A	50mV
The +3.3V and +5V total output shall not exceed 130 watts.				
Total output for this power supply is 400 watts.				
Over Voltage Protection	+3.3V: 3.5V-4.5V			
	+5V: 5.5V-6.82V			
	+12V1 and +12V2: 13.4V-15.6V			
Short Circuit Protection	+3.3V, +5V, +12V or -12V shutdown and latch off			
General Specifications	Watt	400W		
	PFC	Active		
	Hold-up Time	17 ms Min.		
	Efficiency	85%		
	MTBF	100000 hours		
	Temperature	Operating: -5°C ~ 50°C Storage: -20°C ~ 80°C		
	Dimensions (mm)	140 x 150 x 86		
	Output Connector	1 x 20+4-PIN ATX, 1 x 4-pin 12V CPU, 8 x HDD/CDROM, 2 x FDD, 1 x Extra +5V (P10)		



Ordering Information

Part No.	Description
ACE-A140A-S-R11	400W PS/2 ATX Power Supply with ErP & on/off switch, meets 80 PLUS (Bronze)

Dimensions (Unit: mm)

REF. ID.	PIN NO.	SIGNAL	WIRE COLOR	GAUGE	CONNECTOR TYPE	CABLE LENGTH
P1 24	1	+3.3VDC	ORANGE	18	WST P20-142002K11D+ P4-142002K11D or EQUIV.	400±15mm
	2	+3.3VDC	ORANGE	18		
	3	COM	BLACK	18		
	4	+5VDC	RED	18		
	5	COM	BLACK	18		
	6	+5VDC	RED	18		
	7	COM	BLACK	18		
	8	PW-ON	GRAY	22		
	9	+5Vsb	PURPLE	18		
	10	+12V2	YELLOW	18		
	11	+12V2	YELLOW	18		
	12	+3.3VDC	ORANGE	18		
	13	+3.3VDC	ORANGE	18		
	14	-12VDC	BROWN	22		
	15	COM	BLACK	18		
	16	PS-ON	GREEN	22		
	17	COM	BLACK	18		
	18	COM	BLACK	18		
	19	COM	BLACK	18		
	20	-5VDC	WHITE	22		
	21	+5VDC	RED	18		
	22	+5VDC	RED	18		
	23	+5VDC	RED	18		
	24	COM	BLACK	18		
P2	1	COM	BLACK	18	MOLEX 39-01-2040 or EQUIV.	430±15mm
	2	COM	BLACK	18		
	3	+12V1	Yel/Black	18		
	4	+12V1	Yel/Black	18		
PA	1	+12V2	YELLOW	18	AMP 1-480424-0 or EQUIV.	400±15mm
	2	COM	BLACK	18		
	3	COM	BLACK	18		
	4	+5V	RED	18		
PB	1	+12V2	YELLOW	18	AMP 1-480424-0 or EQUIV.	210±10mm
	2	COM	BLACK	18		
	3	COM	BLACK	18		
	4	+5V	RED	18		
PC	1	+12V2	YELLOW	18	AMP 1-480424-0 or EQUIV.	350±15mm
	2	COM	BLACK	18		
	3	COM	BLACK	18		
	4	+5V	RED	18		
PD	1	+5V	RED	22	AMP 171822-4 or EQUIV.	150±10mm
	2	COM	BLACK	22		
	3	COM	BLACK	22		
	4	+12V2	YELLOW	22		
PE	1	+12V2	YELLOW	18	AMP 1-480424-0 or EQUIV.	230±15mm
	2	COM	BLACK	18		
	3	COM	BLACK	18		
	4	+5V	RED	18		
PF	1	+12V2	YELLOW	18	AMP 1-480424-0 or EQUIV.	150±10mm
	2	COM	BLACK	18		
	3	COM	BLACK	18		
	4	+5V	RED	18		
PH	1	+3.3VDC	ORANGE	18	MOLEX SD-67926-0011 or EQUIV.	400±15mm
	2	COM	BLACK	18		
	3	+5V	RED	18		
	4	COM	BLACK	18		
PI	5	+12V1	Yel/Black	18	MOLEX SD-67582-001 or EQUIV.	155±10mm
	1	+3.3VDC	ORANGE	18		
	2	COM	BLACK	18		
	3	+5V	RED	18		
	4	COM	BLACK	18		

- 1 Industrial Computing Solutions
- 2 Video Capture Solutions
- 3 Industrial Computer Chassis
- 4 Open Frame Monitor
- 5 Power Supply/ Peripherals
- 6 All-in-One System

ACE-A130B

300 W PS/2 ATX Power Supply with ErP

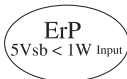

Specifications

Input	Voltage	90-264 VAC Full Range		
	Frequency	47 Hz ~ 63 Hz		
	Input Current	6A (RMS)@115VAC, 3A (RMS)@230VAC		
	Inrush Current	80A max. for 115VAC, 160A max. for 230VAC		
Output	Voltage	Min. load	Max. load	Ripple & Noise
	+3.3V	0.3 A	19 A	50mV
	+5V	0.5 A	16 A	50mV
	+12V1	0.5 A	17 A	120mV
	+12V2	0.5 A	17 A	120mV
	-12V	0A	0.3 A	120mV
	+5VSB	0.1 A	3 A	50mV
	-5V	0 A	0.2 A	100mV
	Total combined output of +3.3V and +5V is ≤105W			
Total output for this power supply is 300 watts				
Over Voltage Protection	+3.3V: 3.7V-4.8V			
	+5V: 5.7V-7.0V +12V1 and +12V2: 13.3V-16V			
Short Circuit Protection	+3.3V, +5V, +12V shutdown and latch off			
	Watt			
General Specifications	300W			
	PFC Active			
	Hold-up Time 13 ms min.			
	Efficiency 85%			
	MTBF 100,000 hours			
	Temperature Operating: -5°C ~ 50°C Storage: -40°C ~ 70°C			
	Dimensions (mm) 140 x 150 x 86			
	Output Connector 1 x 20+4-PIN ATX, 1 x 4-pin 12V CPU, 6 x HDD/CDROM, 1 x FDD, 1 x Extra +5V (P10), 2 x SATA			

Ordering Information

Part No.	Description
ACE-A130B-R10	300W AC-DC PS/2 ATX Power Supply with ErP/PFC, meets 80 PLUS (Bronze)

Dimensions (Unit: mm)

REF. ID.	PIN NO.	SIGNAL	WIRE COLOR	GAUGE	CONNECTOR TYPE	CABLE LENGTH
P1	1	+3.3VDC	ORANGE	20	WST P20-142002K11D+ P4-142002K11D or EQUIV.	500±15mm
	2	+3.3VDC	ORANGE	20		
	3	COM	BLACK	20		
	4	+5VDC	RED	20		
	5	COM	BLACK	20		
	6	+5VDC	RED	20		
	7	COM	BLACK	20		
	8	PW-OK	GRAY	22		
	9	+5Vsb	PURPLE	20		
	10	+12V2	YELLOW	20		
	11	+12V2	YELLOW	20		
	12	+3.3VDC	ORANGE	20		
	13	+3.3VDC	ORANGE	20		
	14	-12VDC	BLUE	22		
	15	COM	BLACK	20		
	16	PS-ON	GREEN	22		
	17	COM	BLACK	20		
	18	COM	BLACK	20		
	19	COM	BLACK	20		
	20	-5VDC	WHITE	22		
21	+5VDC	RED	20			
22	+5VDC	RED	20			
23	+5VDC	RED	20			
24	COM	BLACK	20			
P2	1	COM	BLACK	20	MOLEX 90331-0010 or EQUIV.	500±15mm
	2	COM	BLACK	20		
	3	COM	BLACK	20		
	4	+3.3VDC	ORANGE	20		
P3	1	COM	BLACK	20	MOLEX 39-01-2040 or EQUIV.	500±15mm
	2	COM	BLACK	20		
	3	+12V1	YEL/BLACK	20		
PA	1	+12V1	YEL/BLACK	20	MOLEX SD-67926-0011 or EQUIV.	400±15mm
	2	COM	BLACK	20		
PB	1	+3.3VDC	ORANGE	20	MOLEX SD-67582-001 or EQUIV.	200±10mm
	2	COM	BLACK	20		
	3	+5V	RED	20		
PC	1	+12V1	YEL/BLACK	20	AMP 1-480424-0 or EQUIV.	400±15mm
	2	COM	BLACK	20		
	3	+5V	RED	20		
PG	1	+12V2	YELLOW	20	AMP 1-480424-0 or EQUIV.	200±10mm
	2	COM	BLACK	20		
	3	COM	BLACK	20		
	4	+5V	RED	20		
PJ	1	+5V	RED	20	AMP 171822-4 or EQUIV.	200±10mm
	2	COM	BLACK	20		
	3	COM	BLACK	20		
	4	+12V2	YELLOW	20		

- 1 Industrial Computing Solutions
- 2 Video Capture Solutions
- 3 Industrial Computer Chassis
- 4 Open Frame Monitor
- 5 Power Supply/Peripherals
- 6 All-in-One System

ACE-A130B-S

300 W PS/2 ATX Power Supply with ErP

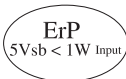

Specifications

Input	Voltage	90-264 VAC Full Range		
	Frequency	47 Hz ~ 63 Hz		
	Input Current	6A (RMS)@115VAC, 3A (RMS)@230VAC		
	Inrush Current	80A max. for 115VAC, 160A max. for 230VAC		
Output	Voltage	Min. load	Max. load	Ripple & Noise
	+3.3V	0.3 A	19 A	50mV
	+5V	0.5 A	16 A	50mV
	+12V1	0.5 A	17 A	120mV
	+12V2	0.5 A	17 A	120mV
	-12V	0A	0.3 A	120mV
	+5VSB	0.1 A	3 A	50mV
	-5V	0 A	0.2 A	100mV
Total combined output of +3.3V and +5V is ≤105W				
Total output for this power supply is 300 watts				
Over Voltage Protection	+3.3V: 3.7V-4.8V			
	+5V: 5.7V-7.0V +12V1 and +12V2: 13.3V-16V			
Short Circuit Protection	+3.3V, +5V, +12V shutdown and latch off			
General Specifications	Watt	300W		
	PFC	Active		
	Hold-up Time	13 ms min.		
	Efficiency	85%		
	MTBF	100,000 hours		
	Temperature	Operating: -5°C ~ 50°C Storage: -40°C ~ 70°C		
	Dimensions (mm)	140 x 150 x 86		
	Output Connector	1 x 20+4-PIN ATX, 1 x 4-pin 12V CPU, 6 x HDD/CDROM, 1 x FDD, 1 x Extra +5V (P10), 2 x SATA		

Ordering Information

Part No.	Description
ACE-A130B-S-R10	300W AC-DC PS/2 ATX Power Supply with ErP/PFC & on/off switch, meets 80 PLUS (Bronze)

Dimensions (Unit: mm)

REF. ID.	PIN NO.	SIGNAL	WIRE COLOR	GAUGE	CONNECTOR TYPE	CABLE LENGTH
P1	1	+3.3VDC	ORANGE	20	WST P20-142002K11D+ P4-142002K11D or EQUIV.	500±15mm
	2	+3.3VDC	ORANGE	20		
	3	COM	BLACK	20		
	4	+5VDC	RED	20		
	5	COM	BLACK	20		
	6	+5VDC	RED	20		
	7	COM	BLACK	20		
	8	PW-OK	GRAY	22		
	9	+5Vsb	PURPLE	20		
	10	+12V2	YELLOW	20		
	11	+12V2	YELLOW	20		
	12	+3.3VDC	ORANGE	20		
	13	+3.3VDC	ORANGE	20		
	14	-12VDC	BLUE	22		
	15	COM	BLACK	20		
	16	PS-ON	GREEN	22		
	17	COM	BLACK	20		
	18	COM	BLACK	20		
	19	COM	BLACK	20		
	20	-5VDC	WHITE	22		
	21	+5VDC	RED	20		
	22	+5VDC	RED	20		
	23	+5VDC	RED	20		
	24	COM	BLACK	20		
P2	1	COM	BLACK	20	MOLEX 90331-0010 or EQUIV.	500±15mm
	2	COM	BLACK	20		
	3	COM	BLACK	20		
	4	+3.3VDC	ORANGE	20		
P3	1	COM	BLACK	20	MOLEX 39-01-2040 or EQUIV.	500±15mm
	3	+12V1	YEL/BLACK	20		
	4	+12V1	YEL/BLACK	20		
PA	1	+3.3VDC	ORANGE	20	MOLEX SD-67926-0011 or EQUIV.	400±15mm
	2	COM	BLACK	20		
	3	+5V	RED	20		
	4	COM	BLACK	20		
	5	+12V1	YEL/BLACK	20		
PB	1	+3.3VDC	ORANGE	20	MOLEX SD-67582-001 or EQUIV.	200±10mm
	2	COM	BLACK	20		
	3	+5V	RED	20		
	4	COM	BLACK	20		
PC	1	+12V2	YELLOW	20	AMP 1-480424-0 or EQUIV.	400±15mm
	2	COM	BLACK	20		
	3	COM	BLACK	20		
	4	+5V	RED	20		
PD	1	+12V2	YELLOW	20	AMP 1-480424-0 or EQUIV.	200±10mm
	2	COM	BLACK	20		
	3	COM	BLACK	20		
	4	+5V	RED	20		
PH	1	+5V	RED	20	AMP 171822-4 or EQUIV.	200±10mm
	2	COM	BLACK	20		
	3	COM	BLACK	20		
	4	+12V2	YELLOW	20		

- 1 Industrial Computing Solutions
- 2 Video Capture Solutions
- 3 Industrial Computer Chassis
- 4 Open Frame Monitor
- 5 Power Supply/ Peripherals
- 6 All-in-One System

ACE-828A



Specifications

Input Type	90 ~ 130 VAC, 180 ~ 260 VAC Auto Range					
Output Voltage	+3.3V	+5V	+12V	-5V	-12V	+5Vsb
	8A	25A (2A min.)	10A (0.1A min.)	0.5A	0.5A	0.72A
Efficiency	65%					
Temperature	Operating: -20°C ~ 70°C (40°C ~ 70°C derating curve) Storage: -40°C ~ 75°C					
MTBF (hrs)	110,000					
Output Connector	1 x 20-pin ATX, 5 x HDD/CDROM, 2 x FDD					

Ordering Information

Part No.	Description
ACE-828A-RS	280W AC-DC PS/2 ATX Power Supply

ACE-828M



Medical



Specifications

Input Type	90 ~ 130 VAC, 180 ~ 260 VAC Auto Range					
Output Voltage	+3.3V	+5V	+12V	-5V	-12V	+5Vsb
	8A	25A (2A min.)	10A (0.1A min.)	0.5A	0.5A	0.72A
Efficiency	65%					
Temperature	Operating: -20°C ~ 70°C (40°C ~ 70°C derating curve) Storage: -40°C ~ 75°C					
MTBF (hrs)	170,000					
Output Connector	1 x 20-pin ATX, 5 x HDD/CDROM, 2 x FDD					

Ordering Information

Part No.	Description
ACE-828M-RS	280W AC-DC PS/2 ATX Power Supply, meets medical standard

PS/2 AC Input AT Type

ACE-932A



Specifications

Input Type	85 ~ 130 VAC, 180 ~ 265 VAC Auto Range					
Output Voltage	+3.3 V	+5 V	+12 V	-5 V	-12 V	+5 Vsb
		33A (3 A min.)	8A (0.2 A min.)	0.5 A	3 A	
Efficiency	68%					
Temperature	Operating: 0°C ~ 50°C (50°C ~ 70°C derating curve) Storage: -40°C ~ 75°C					
MTBF (hrs)	120,000					
Output Connector	1 x P8+P9, 1 x Extra +5V (P10), 4 x HDD/CDROM, 2 x FDD					

Ordering Information

Part No.	Description
ACE-932A-RS	300 W AC-DC PS/2 AT Power Supply

ACE-935AL



Specifications

Input Type	85 ~ 140 VAC, 170 ~ 270 VAC Auto Range					
Output Voltage	+3.3 V	+5 V	+12 V	-5 V	-12 V	+5 Vsb
		40 A (3A min.)	8 A (0.1A min.)	0.3 A	0.7 A	
Efficiency	68%					
Temperature	0°C ~ 50°C (Operating), -40°C ~ 75°C (Storage)					
MTBF (hrs)	100,000					
Output Connector	1 x P8+P9, 1 x Extra +5V (P10), 5 x HDD/CDROM, 2 x FDD					

Ordering Information

Part No.	Description
ACE-935AL-RS	300 W AC-DC PS/2 AT Power Supply, AC select switch

1

Industrial Computing Solutions

2

Video Capture Solutions

3

Industrial Computer Chassis

4

Open Frame Monitor

5

Power Supply/ Peripherals

6

All-in-One System

ACE-925AP-U 250 W PS/2 Type AT Power Supply



High reliability magnetic bearing cooling system features low noise, high operating temperature and longer MTBF

Specifications

Input	Voltage	90 ~ 265 VAC Full Range			
	Frequency	47 Hz ~ 63 Hz			
Output	Voltage	+5 V	+12 V	-5 V	-12 V
	Max. Load	22 A	11 A	0.5 A	0.7 A
General	MTBF	100,000 hours			
	Temperature	Operating: 0°C ~ 50°C Storage: -25°C ~ 70°C			
	Dimensions (mm)	140 x 150 x 86			
	Output Connector	1 x P8+P9, 4 x HDD/CDROM, 2 x FDD, 2 x SATA			

Ordering Information

Part No.	Description
ACE-925AP-U-RS	250 W AC-DC PS/2 AT Power Supply, with PFC

ACE-925A 200 W PS/2 Type AT Power Supply



Specifications

Input Type	85 ~ 265 VAC Full Range					
Output Voltage	+3.3 V	+5 V	+12 V	-5 V	-12 V	+5 Vsb
		22 A (1A min.)	7 A (0.1A min.)	0.5 A	0.7 A	
Efficiency	68%					
Temperature	0°C ~ 50°C (Operating), -40°C ~ 75°C (Storage)					
MTBF (hrs)	130,000					
Output Connector	1 x P8+P9, 5 x HDD/CDROM, 2 x FDD					

Ordering Information

Part No.	Description
ACE-925A-RS	200 W AC-DC PS/2 AT Power Supply

PS/2 DC Input ATX Type

ACE-828C 250 W PS/2 24 V DC Input ATX Type

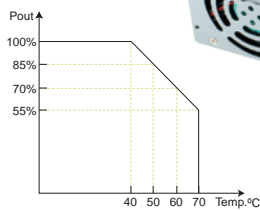

Specifications

Input Type	18 ~ 32 VDC					
Input Current	20 A (RMS)@24VDC			Inrush Current		
				5A Max for 24VDC		
Output Voltage	+3.3 V	+5 V	+12 V	-5 V	-12 V	+5 Vsb
	8 A	25 A (2A min.)	7 A (0.1 min.)	0.5 A	1 A	0.72 A
Ripple & Noise	+5 V, +3.3 V output are less than 50mV +12 V, -5 V, -12 V, +5 Vsb output are less than 100mV					
Overvoltage Protection	+5 V: 5.7 V ~ 7.0 V					
Short Circuit Protection	Yes			Overload Protection		Yes
Efficiency	65%					
Temperature	-20°C ~ 70°C (Operating), -40°C ~ 75°C (Storage)					
MTBF (hrs)	120,000					
Power Good Signal	Turn on delay time: 100 ms to 500 ms					
Output Connector	1 x P8+P9, 1 x Extra +5V (P10), 4 x HDD/CDROM, 2 x FDD					

Ordering Information

Part No.	Description
ACE-828C-RS	250 W 24V DC Input PS/2 Type ATX Power Supply

1

Industrial Computing Solutions

2

Video Capture Solutions

3

Industrial Computer Chassis

4

Open Frame Monitor

5

Power Supply/ Peripherals

6

All-in-One System

Optional Power Supply Cables

■ AC Input Solution

20 cm AC input cable with I/O connector and fuse

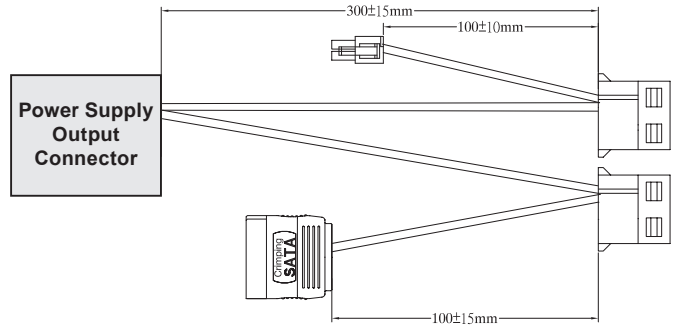
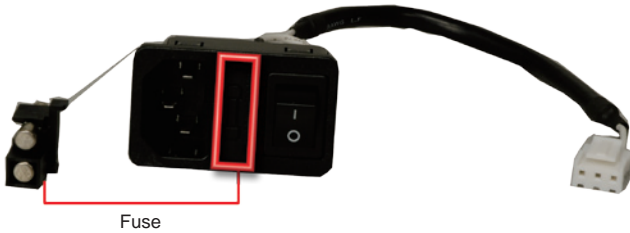

■ Embedded Solution

30 cm cable with SATA, 12 V and IDE device connectors

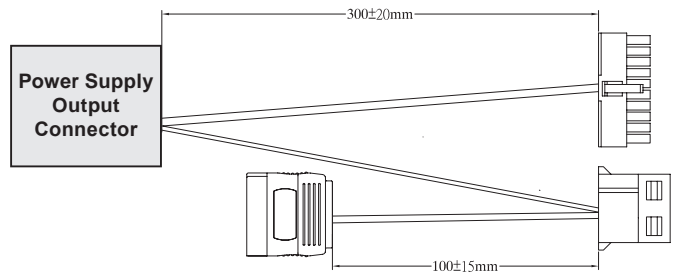

■ ATX Backplane Solution

30 cm cable with IDE, ATX and SATA device connectors

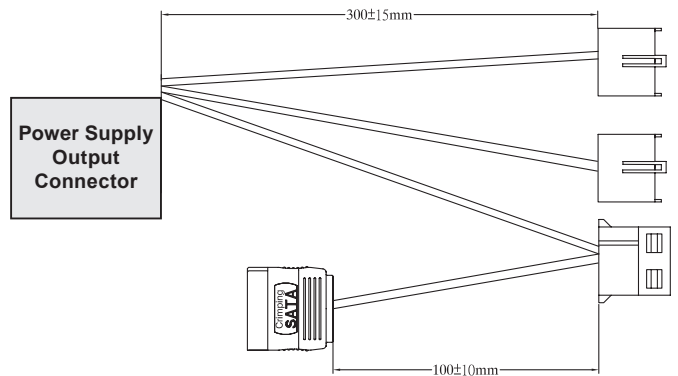
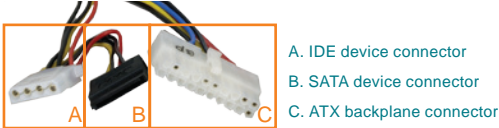

■ AT P8P9 Backplane Solution

30 cm cable with SATA, IDE and P8P9 AT device connectors

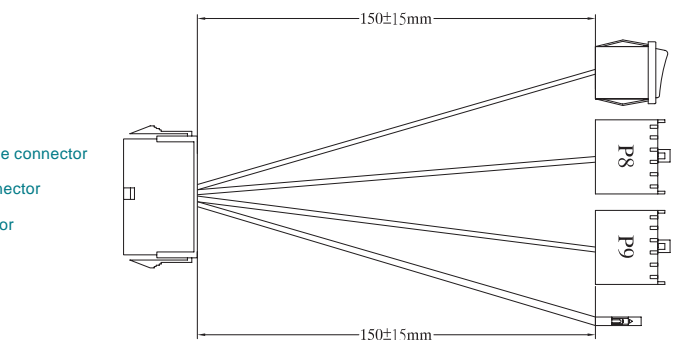

■ AT Backplane with ATX Power Supply Solution

15 cm cable with ATX, P8P9 and 5VSB connectors, and on/off switch



1 Industrial Computing Solutions

2 Video Capture Solutions

3 Industrial Computer Chassis

4 Open Frame Monitor

5 Power Supply/ Peripherals

6 All-in-One System

Optional Power Supply Cables

CB-704EC-RS



CB-870EC-RS



32102-037300-100-RS



CB-709EB-RS



CB-716EB-RS



CB-717BP-RS



CB-855EB-RS

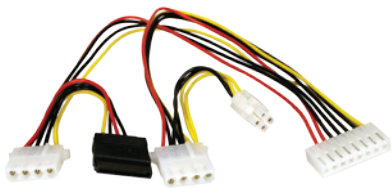

CB-716P8P9

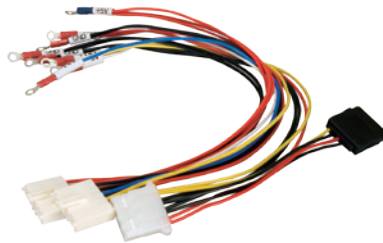

CB-870P8P9

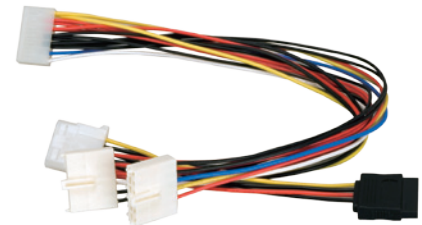

CB-890P8P9

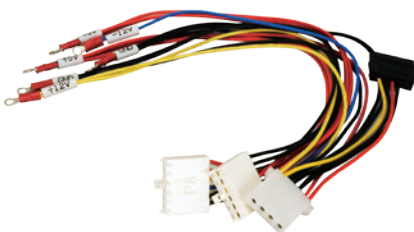

1

Industrial Computing Solutions

2

Video Capture Solutions

3

Industrial Computer Chassis

4

Open Frame Monitor

5



Power Supply/ Peripherals

6

All-in-One System

Redundant Type Selection Guide

AC Input

Product	Model No.	Watt AT/ATX PFC	Input Range Voltage	Output Current Range						Efficiency	Operating Temperature	Safety	Dimensions (mm)
				+3.3 V	+5 V	+12 V	-5 V	-12 V	+5 Vsb				
	ACE-R4140AP	400W ATX PFC	90 ~ 264 VAC	25 A (2 A min.)	25 A (2 A min.)	30 A (2.5 A min.)		0.8 A (0.1 A min.)	2 A (0.1 A min.)	65%	0°C ~ 40°C	UL, TUV, CCC, BSMI, CE, FCC	150 x 85 x 190
	ACE-R4130AP	300W ATX PFC	90 ~ 264 VAC	18 A (1 A min.)	25 A (3 A min.)	16 A (2 A min.)	0.5A	0.5 A	2 A (0.1 A min.)	65%	0°C ~ 50°C	CB, UL, TUV, CCC, CE, FCC	185 x 150 x 86

ACE-R4140AP

400 W ATX Mini Redundant Power Supply



Dimensions (Unit: mm)

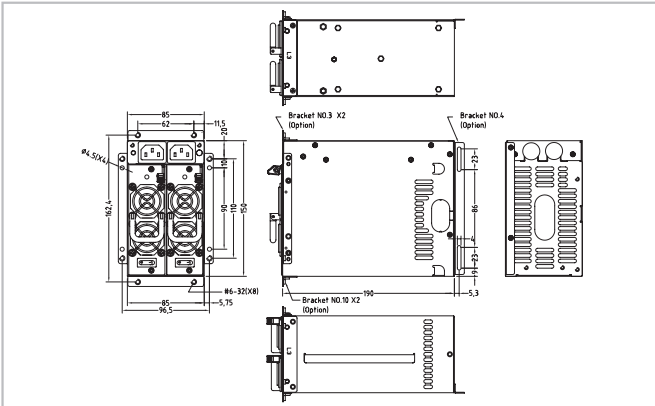

Specifications

Input	Voltage	90 ~ 264 VAC Full Range		
	Frequency	47 Hz ~ 63 Hz		
	Input Current	8 A (RMS) @ 100 VAC, 4 A (RMS) @ 240 VAC		
	Inrush Current	34.4A Max for 100 VAC, 68A Max for 264VAC		
Output	Voltage	Min. load	Max. load	Ripple & Noise
	+5 V	2 A	25 A	50 mV P-P
	+12 V	2.5 A	30 A	120 mV P-P
	-12 V	0.1 A	0.8 A	120 mV P-P
	+3.3 V	2 A	25 A	50 mV P-P
	+5 Vsb	0.1 A	2 A	50 mV P-P
	+5 V, +12 V total current not exceed 150 W +3.3 V, +5 V, +12 V total current not exceed 440 W			
General Specification	Hold up Time	17 ms min.		
	Efficiency	65% min		
	MTBF	100,000 hours on max. load at +25°C		
	Temperature	Operating: 0°C ~ 50°C, Storage: -40°C ~ 70°C		
	Dimensions	150 x 85 x 190 (mm)		
	Output Connector	1 x 20+4-pin ATX, 1 x 4-pin 12V CPU, 8 x HDD/CDROM, 2 x FDD, 2 x SATA, 1 x Buzzer reset, 1 x T.T.L signal, 1 x LED power		

Ordering Information

Part No.	Description
ACE-R4140AP-RS	400W Mini Redundant ATX Power Supply, with PFC
ACE-R4140AP1-RS	400W AC-DC ATX Redundant Module, for ACE-R4140AP, with PFC

ACE-R4130AP

300 W ATX Mini Redundant Power Supply



Dimensions (Unit: mm)

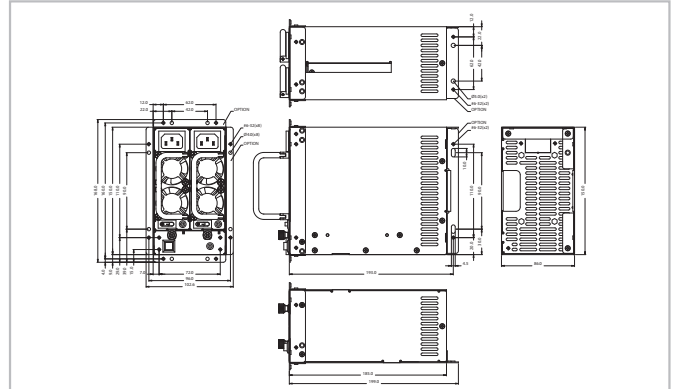

Specifications

Input	Voltage	90 ~ 264 VAC Full Range		
	Frequency	47 Hz ~ 63 Hz		
	Input Current	6 A (RMS) @ 110 VAC, 3 A (RMS) @ 220 VAC		
	Inrush Current	60 A max. for 110 VAC, 80 A max. for 220 VAC		
Output	Voltage	Min. load	Max. load	Ripple & Noise
	+5 V	3 A	25 A	50mV P-P
	+12 V	2 A	16 A	120mV P-P
	-5 V	0 A	0.5 A	150mV P-P
	-12 V	0 A	0.5 A	150mV P-P
	+3.3 V	1 A	18 A	50mV P-P
	+5 Vsb	0.1 A	2 A	60mV P-P
*Total current of +5 V and +3.3 V not exceed 35 A *Total current of +5 V, +3.3 V and +12 V not exceed 282 W				
General Specifications	Watt	300 W		
	Hold-up Time	16 ms min.		
	Efficiency	65% min.		
	MTBF	160,000 hours		
	Temperature	Operating: 0°C ~ 50°C, Storage: -20°C ~ 80°C		
	Dimensions	185 x 150 x 86 (mm), 7.28 x 5.91 x 3.39 (inch)		
Output Connector	1 x 20+4-pin ATX, 1 x 4-pin 12V CPU, 8 x HDD/CDROM, 2 x FDD, 2 x SATA, 1 x Buzzer reset, 1 x T.T.L signal, 1 x LED power			

Ordering Information

Part No.	Description
ACE-R4130AP-RS	300 W Mini Redundant ATX Power Supply, with PFC
ACE-R4130AP1-RS	300 W AC-DC ATX Redundant Module, for ACE-R4130AP, with PFC

1 Industrial Computing Solutions

2 Video Capture Solutions

3 Industrial Computer Chassis

4 Open Frame Monitor

5 Power Supply/ Peripherals

6 All-in-One System

Adapter Type Selection Guide

Safety (ITE Standard) - CB IEC 60950, UL 60950, CSA C 22.2 No. 60950, TUV EN 60950

Safety (Medical Standard) - CB IEC 60601, UL 60601, CSA C 22.2 No. 60601, TUV EN 60601









EMI - Meets EN 55022, FCC Part 15, CISPR 22

Meets EN 61000-3-2, EN 61000-3-3 (PFC function)

EMS - Meets EN 55024, EN 61000-4-2/3/4/5/6/8/11

* For detailed specs, please refer to official certification

AC Input

Product	Model No.	Watt	Input Range	Output Current Range			Plug Type	Efficiency	Operating Temperature	Safety	Dimensions (mm)
			Voltage	+5V	+12 V	+19 V					
	FSP120-ABBN2	120W	90~264 VAC			6.32 A		91.57%	0°C ~ 40°C	UL/TUV/CCC/CE/GS/PSE	75.6 x 15.3 x 25.4
	FSP096-AHAN2	96W	90~264 VAC		8 A			89%	0°C ~ 40°C	UL/TUV/CCC/CE/GS/PSE	75.6 x 15.3 x 25.4
	FSP090-DIEBN2	90W	90~264 VAC			4.74 A		87%	0°C ~ 40°C	UL/TUV/CCC/CE/GS/PSE/KC/BSMI/RCM/EAC/PSB	51 x 129 x 30.9
	FSP065-REBN2	65W	90~264 VAC			3.42 A		89.54%	0°C ~ 40°C	UL/TUV/CCC/CE/BSMI/PSE/PSB/GS/EAC/NOM/RCM/IRAM/Nrcan/Nemko	46.3 x 108.3 x 30
	Medical 63040-010060-020	60W	90~264 VAC		5V			85%	0°C ~ 60°C	CB/UL/TUV/CCC/BSMI/CE/FCC	147 x 75 x 49
	FSP060-DIBAN2	60W	90 ~ 264 VAC		5V			88.57%	0°C ~ 40°C	UL/TUV/CCC/GS/PSE/PSB/RCM/EAC/CE/Nrcan/KC/BSMI	62 x 110 x 31.5
	FSP036-RBBN2	36W	90 ~ 264 VAC		3 A			86%	0°C ~ 40°C	UL/TUV/CCC/GS/CE/BSMI/PSE/RCM	37.8 x 89.8 x 27

1

Industrial Computing Solutions

2

Video Capture Solutions

3

Industrial Computer Chassis

4

Open Frame Monitor

5

Power Supply/Peripherals

6

All-in-One System

FSP120-ABBN2

120 W AC/DC Adapter

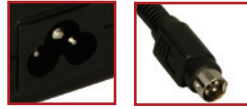

Plug Type: Power mini-DIN (4P)

****Meet ErP**



Specifications

- Input Voltage Range: 90-264 VAC
- Input Frequency: 47-63 Hz
- Output Voltage: 19 V
- Output Current: 6.32 A
- Output Watts: 120 W
- Efficiency: 91.57%
- Operating Temperature: 0°C ~ 40°C
- Storage Temperature: -20°C ~ 80°C

Optional Cable



PN: CB-MD4P4-RS
16 cm cable for power mini-DIN connector adapter

Dimensions (Unit: mm)

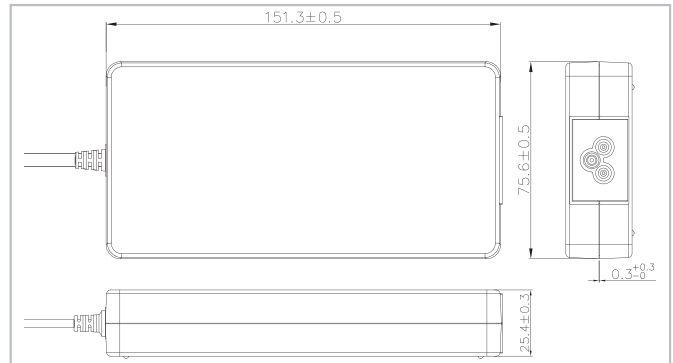

Ordering Information

Part No.	Description
63000-FSP120AAB-RS	19 V 120W power adapter, 90-264 VAC input, ErP, PSE

FSP096-AHAN2

96 W AC/DC Adapter

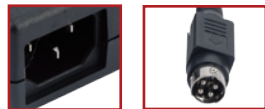

Plug Type: øin 2.5 mm / øout 5.5 mm

****Meet ErP & PSE**



Specifications

- Input Voltage Range: 90-264 VAC
- Input Frequency: 47-63 Hz
- Output Voltage: 12 V
- Output Current: 8 A
- Output Watts: 96 W
- Efficiency: 89%
- Operating Temperature: 0°C ~ 40°C
- Storage Temperature: -20°C ~ 80°C

Optional Cable



PN: CB-MD4P4-RS
16 cm cable for power mini-DIN connector adapter

Dimensions (Unit: mm)

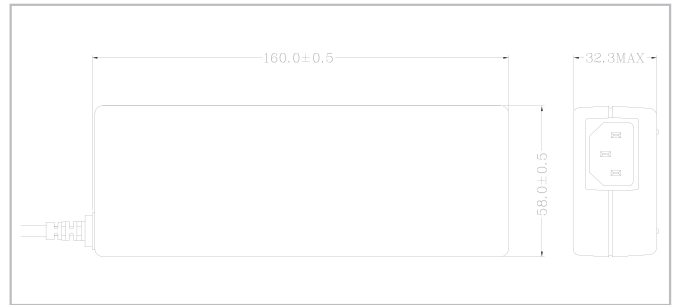

Ordering Information

Part No.	Description
63040-010096-100-RS	12V 96W power adapter with DIN 4-pin/lock 90-264 VAC input, ErP, PSE

FSP090-DIEBN2

87 W AC/DC Adapter



Plug Type: Power mini-DIN (4P)

****Meet ErP & PSE**



Specifications

- Input Voltage Range: 90-264 VAC
- Input Frequency: 47-63 Hz
- Output Voltage: 19 V
- Output Current: 4.74 A
- Output Watts: 87 W
- Efficiency: 86%
- Operating Temperature: 0°C ~ 40°C
- Storage Temperature: -30°C ~ 60°C

Optional Cable



PN: CB-MD4P4-RS
16 cm cable for power mini-DIN connector adapter

Dimensions (Unit: mm)

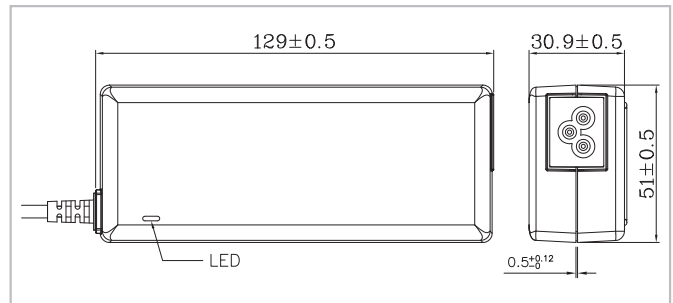

Ordering Information

Part No.	Description
63040-010090-020-RS	19V 90W power adapter with DIN 4-pin/lock 90-264 VAC input, ErP

1

Industrial Computing Solutions

2

Video Capture Solutions

3

Industrial Computer Chassis

4

Open Frame Monitor

5

Power Supply / Peripherals

6

All-in-One System

FSP065-REBN2

65 W AC/DC Adapter



Plug Type: ϕ in 2.1 mm / ϕ out 5.5 mm

****Meet ErP & PSE**



Specifications

- Input Voltage Range: 90-264 VAC
- Input Frequency: 47-63 Hz
- Output Voltage: 19 V
- Output Current: 3.42 A
- Output Watts: 65 W
- Efficiency: 89.54%
- Operating Temperature: 0°C ~ 40°C
- Storage Temperature: -20°C ~ 75°C

Dimensions (Unit: mm)

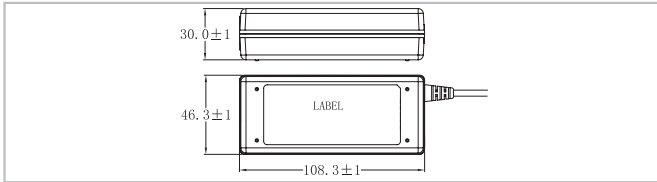

Ordering Information

Part No.	Description
63040-010065-010-RS	19V 65W power adapter with Φ 2.1/ Φ 5.5/lock 90-264 VAC input, ErP, PSE

FSP060-DIBAN2

60 W AC/DC Adapter



Plug Type: ϕ in 2.5 mm / ϕ out 5.5 mm

****Meet ErP & PSE**



Specifications

- Input Voltage Range: 90-264 VAC
- Input Frequency: 47-63 Hz
- Output Voltage: 12 V
- Output Current: 5 A
- Output Watts: 60 W
- Efficiency: 88.9%
- Operating Temperature: 0°C ~ 40°C
- Storage Temperature: -20°C ~ 65°C

Dimensions (Unit: mm)



Ordering Information

Part No.	Description
63040-010060-120-RS	12 V 60W power adapter with lock screw 90-264 VAC input, ErP, PSE
63040-010060-130-RS	12V 60W power adapter with none lock 90-264 VAC input, ErP, PSE

63040-010060-020

60 W AC/DC Adapter



Plug Type: ϕ in 2.5 mm / ϕ out 5.5 mm

Medical

****Meet ErP**



Specifications

- Input Voltage Range: 90-264 VAC
- Input Frequency: 47-63 Hz
- Output Voltage: 12 V
- Output Current: 5 A
- Output Watts: 60 W
- Efficiency: 85%
- Operating Temperature: 0°C ~ 60°C
- Storage Temperature: -40°C ~ 85°C

Optional Cable



PN: CB-P1LP4-RS

20 cm cable for 5.5 x 2.5 DC Plug with screw

Dimensions (Unit: mm)

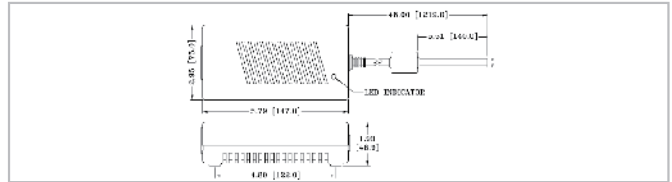

Ordering Information

Part No.	Description
63040-010060-020-RS	12V 60W medical power adapter with Φ 2.5/ Φ 5.5 90-264 VAC input, ErP

FSP036-RBBN2

36 W AC/DC Adapter



Plug Type: ϕ in 2.5 mm / ϕ out 5.5 mm

****Meet ErP & PSE**



Specifications

- Input Voltage Range: 90-264 VAC
- Input Frequency: 47-63 Hz
- Output Voltage: 12 V
- Output Current: 3 A
- Output Watts: 36 W
- Efficiency: 86%
- Operating Temperature: 0°C ~ 40°C
- Storage Temperature: -20°C ~ 70°C

Optional Cable



PN: CB-P1LP4-RS

20 cm cable for 5.5 x 2.5 DC Plug with screw

Dimensions (Unit: mm)

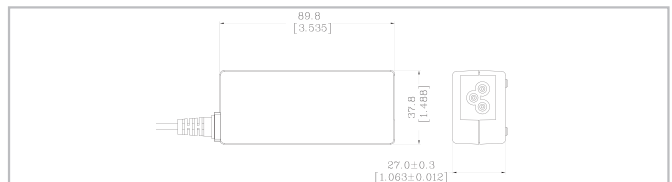

Ordering Information

Part No.	Description
63040-010036-121-RS	12V 36W Power adapter with lock screw, 90-264VAC input, ErP, PSE
63040-010036-111-RS	12V 36W Power adapter without lock, 90-264VAC input, ErP, PSE

1

Industrial Computing Solutions

2

Video Capture Solutions

3

Industrial Computer Chassis

4

Open Frame Monitor

5

Power Supply/ Peripherals

6

All-in-One System

How to Configure the IDD & PM_P Series

AT Mode

1. Power supply without any control signal
2. Power is controlled directly by the power supply's on/off switch.

■ Installation

Step 1. Set the jumper on the power modules and SBC to AT mode (if available)

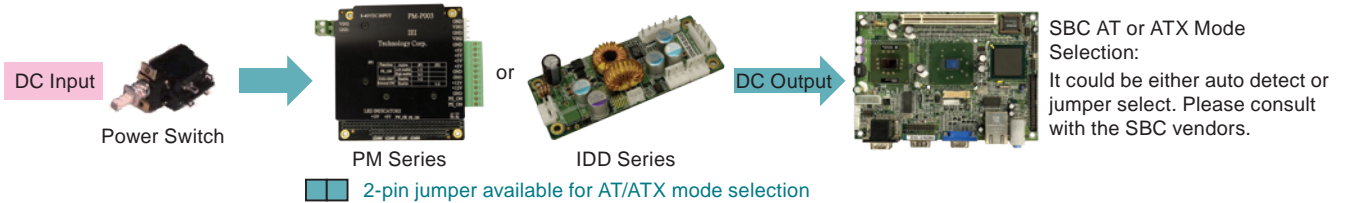

Step 2. Connect all input and output power cables **Step 3.** Wire/Isolate DC input by power switch **Step 4.** Power up by switch

ATX Mode (supports normal Windows® OS power down)

1. Required 5VSB (5V standby power) to SBC.
2. Power supply on/off control by "PS_On#" signal.
3. PS_On# is an active low signal that turns on all power rails.

■ Installation

Step 1. Set the jumper on the power modules and SBC to ATX mode (if available)

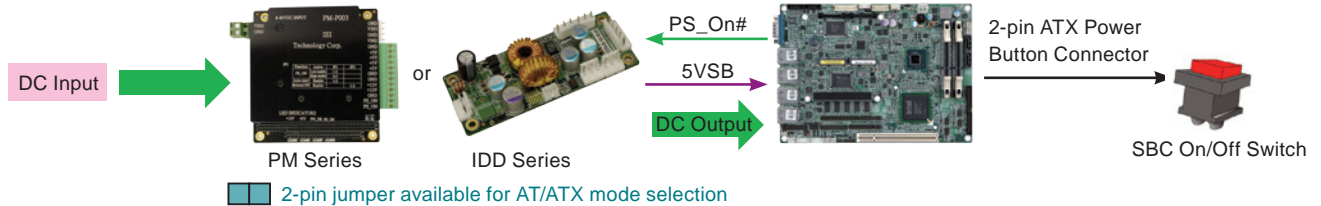

Step 2. Wire 5VSB and PS_ON# from power module to SBC **Step 3.** Wire all input, output power cables **Step 4.** Power up system by SBC on/off switch

Simulated AT Mode

1. The 5 V standby power is not provided to the SBC.
2. Power supply power is controlled by the "PS_On#" signal.
3. The power switch is connected to the power supply.

■ Installation

Step 1. Set the jumper on the power modules to ATX mode and set the jumper on the SBC to AT mode (if available)

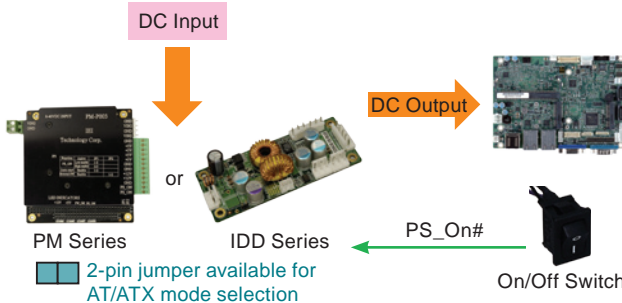

Step 2. Connect 5VSB & PS_ON# from the power module to the SBC.
Step 3. Connect all input and output power cables.
Step 4. Power up the system using the power switch connected to the SBC.

From Scratch to Sustain - Commitment

A partnership with IEI does not end at product shipment. We're beside you with ongoing product support as your products evolve and change to meet emerging market requirements.

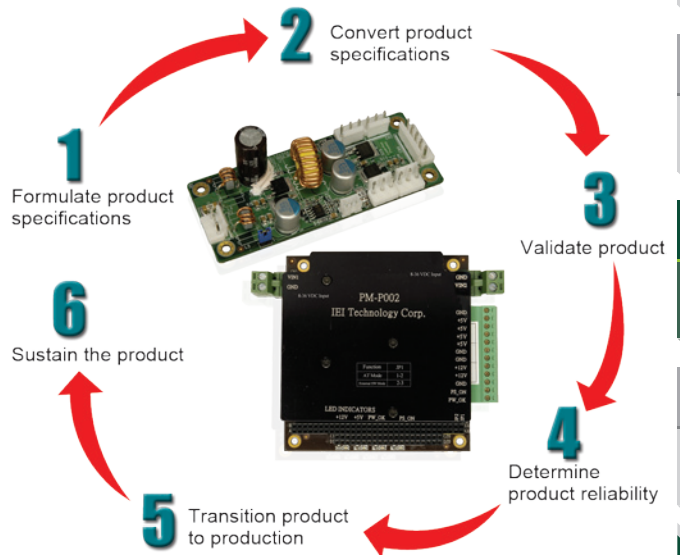

- 1 Industrial Computing Solutions
- 2 Video Capture Solutions
- 3 Industrial Computer Chassis
- 4 Open Frame Monitor
- 5 Power Supply/ Peripherals
- 6 All-in-One System

Product List

Model No.	Dimensions	Maximum Output Power	Input Voltage	Maximum Output Current						
				12V	5V	3.3V	-12V	5VSB	16V	20V
IDDV-6304140A	45 mm x 160 mm	140 W	6 ~ 30 V	4 A	10 A	10 A	0.15 A	1.5 A	-	-
IDD-9364120A	45 mm x 160 mm	120 W	9 ~ 36 V	4 A	10 A	8 A	0.3 A	2 A	-	-
IDD-241100	40 mm x 100 mm	100 W	24 V	8.3 A	-	-	-	-	-	-
IDD-936160	25 mm x 82 mm	60 W	9 ~ 36 V	5 A	-	-	-	-	-	-
PM-P006UPS	3.775" x 3.55"	65 W	6 ~ 36 V	4 A	10 A	8 A	-	1 A	-	-
IDD-930160-KIT	42 mm x 103 mm x 31 mm	60 W	9 ~ 30 V	5 A	-	-	-	-	-	-
IDD-936260A	40 mm x 100 mm	60 W	9 ~ 36 V	3 A	10 A	-	-	0.5 A	-	-
IDD-12250A	40 mm x 100 mm	50 W + 60 W	12 V	5 A	10 A	-	-	0.5 A	-	-

Naming Conventions:

PM-P xxx yy

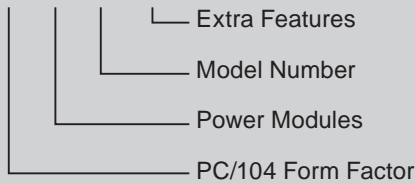

IDD xx - 630 4 120 A

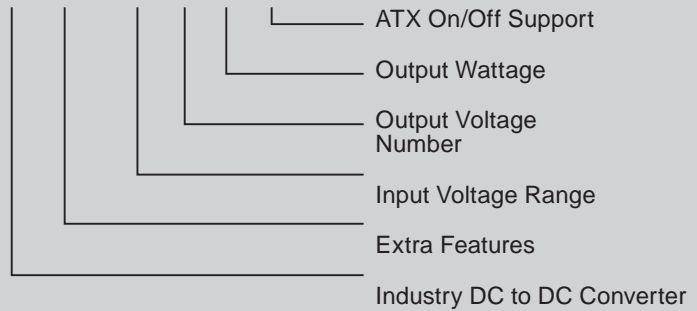

Output Power Calculation

P (Wattage) = V (Voltage) x I (Current)

P_t = Total Output Power

I_1 = Current of Output Voltage1

I_n = Current of Output Voltagen

V_1 = Output Voltage1

V_n = Output Voltagen

$P_t = V_1 \times I_1 + V_2 \times I_2 + \dots + V_n \times I_n$

P_t must be less than max. output power and individual output current must not exceed max. output current.

1

Industrial Computing Solutions

2

Video Capture Solutions

3

Industrial Computer Chassis

4

Open Frame Monitor

5

Power Supply/ Peripherals

6

All-in-One System

Dedicated Engineering Team - Professional

Our dedicated team offers application-specific integrated solutions and will design a customized product that will put you out in front of the competition.

Our solutions include standard/non-standard voltages, isolated/non-isolated, any form factor, power sequencing, battery chargers, electromechanical interference protection, thermal management, remote on/off and I/O interface.



Advanced Test Equipment – Precision & Reliability



Timing/Noise Analyzer Chroma 6011



Electronic Load Chroma 6312 Series



Power Analyzer Chroma 6632

IDDV-6304140A

140 W DC/DC Smart ATX Converter Module for Vehicle

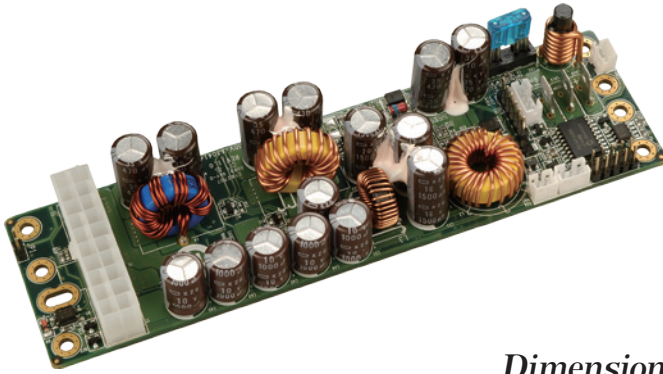

Dedicated ATX power for car PC and battery powered applications

Designed to provide power and to control power on/off switch of a motherboard based on the ignition status.

Dimensions (Unit: mm)

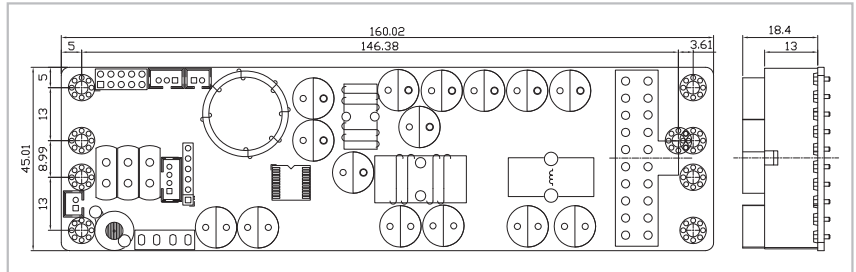

Features

1. Wide input range: 6-30 VDC
2. Smart system on/off control
3. Six selectable power on/off timing modes
4. Load down protection
5. Over voltage protection
6. Short circuit protection
7. Over current protection
8. Battery voltage monitor
9. Amplifier on-delay control
10. RoHS compliant
11. Compact size
12. Infrared remote off (optional)

Specifications

- Output (max.): 5 V@10 A, 3.3 V@10 A, 12 V@4 A, -12 V@0.15 A & 5VSB@1.5 A
- Max. total output: 140 W
- Input: 6 VDC to 30 VDC
Min. input operating voltage: 5.7 V
Max. input operating voltage: 30 V
- Deep-discharge shut down voltage: 10.6 V
- Startup voltage: 8 V
- Efficiency: up to 90%
- Dimensions (mm): 45 x 160
- Weight (NW): 118 g
- Operating temperature: -20°C ~ 85°C
- Storage temperature: -25°C ~ 90°C

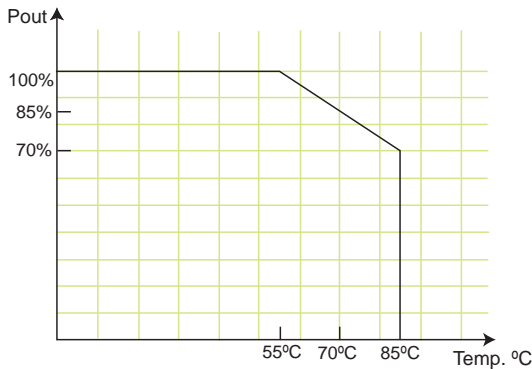

Pin Assignments

Input Power Connector

CN15	Batt (+)
CN16	ACC ON
CN17	Batt (-)

Output Power Connector

J1	Standard 20-pin ATX
----	---------------------

Wire Harness Selection Guide

SBC Main Power (J1)



PN: CB-ATX20PIO-RS
20-pin ATX to 20-pin ATX / SATA / HDD cables

Input Power Connector (CN15, 16, 17)



PN: CB-BATACC-RS
Wire to battery and ACC on

Packing Information

- 1 x IDDV-6304140A
- 1 x QIG
- 1 x Wire cable for PWR/SW and MB/SW (P/N: 32100-153400-RS)
- 1 x Wire cable for LED/AMP (P/N: 32100-153500-RS)

Ordering Information

Part No.	Description
IDDV-6304140A-R10	140 W DC/DC 6-30 VDC input, vehicle converter module
CB-ATX20PIO-RS	30 cm, 20-pin ATX to 20-pin ATX / SATA (20 cm) / HDD cables
CB-BATACC-RS	30 cm, wire to battery and ACC on

1

Industrial Computing Solutions

2

Video Capture Solutions

3

Industrial Computer Chassis

4

Open Frame Monitor

5

Power Supply/ Peripherals

6

All-in-One System

■ PCs Still Consume Power While Off

A typical PC consumes 500mW of power when the system is powered off. The current computer market trend demands more and more standby power.

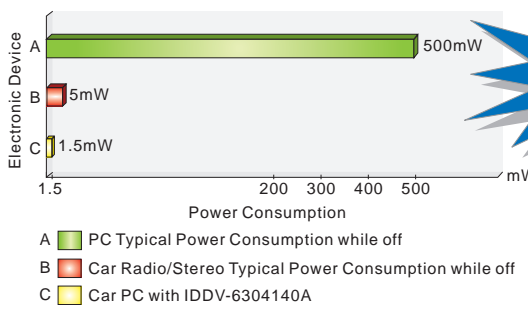

333 Times



Standard ATX Power Supply will Drain the Car Battery!

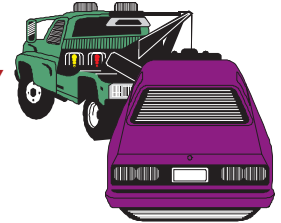

How the IDDV-6304140A works to keep your battery alive

- Step1. Ignition=Off**
The IDDV-6304140A cuts off all the power rails including 5VSB. The internal μ P power consumption keeps less than 1.5mW.
- Step2. Ignition=On (ACC On)**
The IDDV-6304140A waits for 10 seconds then turns on the 5VSB rail.
Auto On (jumper selectable) - After 1 second, the μ P sends an "ON" signal to the motherboard via the two wires connected to the motherboard's on/off pins.
Manual On (jumper selectable) - Nothing happens until the power button on the IDDV-6304140A is pushed.
- Step3. Ignition=On**
During driving: acts like a regular PC, turns on/off anytime by pushing the on/off button.
- Step4. Ignition=Soft Off**
The IDDV-6304140A waits for "10-40" seconds (jumper selectable), and then μ P sends a signal to turn off the motherboard. The computer should turn off gracefully during the shutdown procedure. During this period, normal power will be available for the system to perform normal shutdown.
- Step5. Ignition=Hard Off**
5VSB is still available for 0 seconds, 45 seconds, 1 hour, or never (jumper selectable) before being cut off by μ P. At this stage, the system will keep minimum power consumption so that the system won't drain the car battery.

1

Industrial Computing Solutions

■ 12V Battery Vehicle Load Dump Transients

'Load dump' transients occur when a battery are disconnected from the charging system during charge. The alternator, with a finite response time of 40ms to 400ms, generates power with nowhere to go. This damages electronic devices.

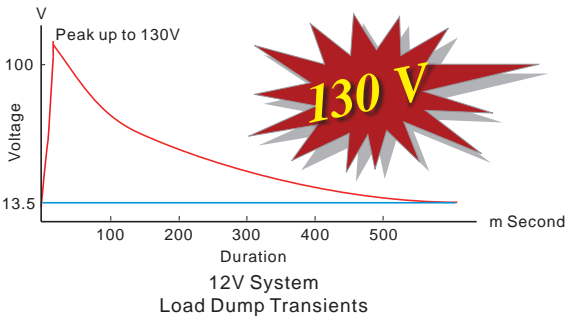

Load dump transients typically reach peak voltages of 130 volts in 12 volt systems with relatively slow rise times.

2

Video Capture Solutions

3

Industrial Computer Chassis

EMI sprays and RFI sparking is everywhere. Electrical transients run zapping embedded electronic components. The electronic components located in a vehicle must withstand 600V transients and "load dump" situations.

4

Open Frame Monitor

■ IDDV-6304140A Wiring Diagram

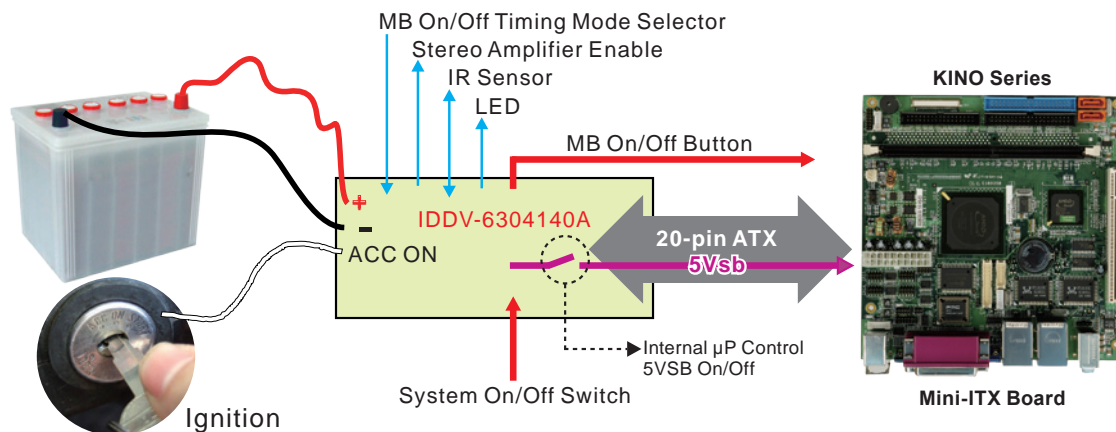

5

Power Supply/ Peripherals

6

All-in-One System

IDD-9364120A

120 W DC/DC Converter Module

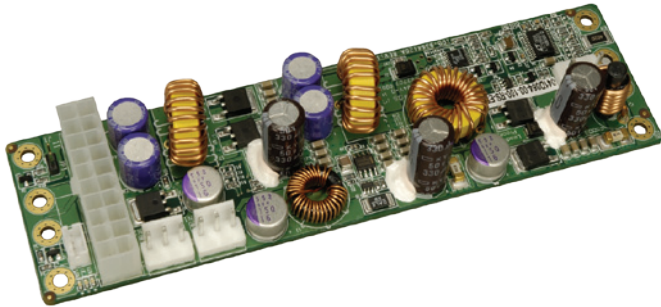

Features

1. Wide input range: 9-36 VDC
2. AT or ATX mode on/off
3. Output voltage protection
4. Up to 90% efficiency
5. RoHS compliant
6. Compact size

Dimensions (Unit: mm)

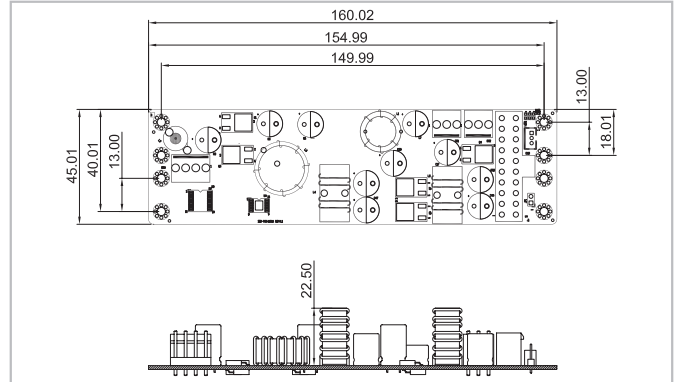

Specifications

- Output (max.): 12 V@4 A, 5 V@10 A, 3.3 V@8 A, -12 V@0.3 A & 5VSB@2 A
- Max. total output: 120 W
- Input: 9 VDC to 36 VDC
- Performance characteristics
 - Noise & ripple: <240 mV
 - Line regulation: <50 mV
 - Load regulation: <100 mV
 - Efficiency: Up to 90%
- Dimensions (mm): 45 x 160
- Weight (NW): 104 g
- Operating temperature: -20°C ~ 70°C
- Storage temperature: -25°C ~ 75°C

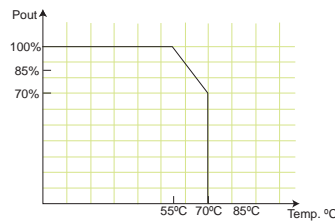

Pin Assignments

Input Power Connector

CN4	Pin 1	Pin 2	Pin 3	Pin 4
	VIN	VIN	GND	GND

Output Power Connector

CN1, CN2	Pin 1	Pin 2	Pin 3
	+5 V	GND	+12 V

J1	Standard 2-pin ATX

ATX Mode Connector

CN3	Pin 1	Pin 2	Pin 3
	5VSB	GND	PS_ON

Wire Harness Selection Guide

DC Input (CN4)



Option 1.
PN: CB-P1LP4-RS
 Cable for FSP0601AD101C 60 W/ UP0451E12P 45 W/UP0251E12PL 25W AC-DC adapter



Option 2.
PN: CB-MD4P4-RS
 Cable for 63000-FSP120AAB-RS 120 W AC-DC adapter



Option 3.
PN: CB-NOLP4-RS
 Cable for terminal block

SBC Main Power (J1)



Option 1.
PN: 32102-021500-200-RS
 20-pin ATX to 20-pin ATX cable

I/O Power (CN1 & CN2)



Option 1.
PN: CB-3PSATA-RS
 Cable for SATA



Option 2.
PN: CB-3PIDE-RS
 Cable for IDE HDD or any STD 4-pin I/O devices

Power On/Off (CN3)



Option 1.
PN: CB-JST3PSW-RS
 Cable with on/off switch



Option 2.
PN: CB-JST3P001-RS
 Cable to SBC (5VSB & PS_ON)

Packing Information

1 x IDD-9364120A

1 x QIG

Ordering Information

Part No.	Description
IDD-9364120A-R11	120 W DC/DC 9~36 V input, 12 V, 5 V, 3.3 V, -12 V & 5VSB output
CB-JST3PSW-RS	30 cm cable on/off switch
CB-JST3P001-RS	30 cm 5VSB, PS_ON wire to SBC
CB-3PSATA-RS	10 cm cable for SATA power
CB-3PIDE-RS	10 cm cable for IDE HDD power
CB-P1LP4-RS	20 cm cable for FSP0601AD101C 60 W/UP0451E12P 45 W/UP0251E12PL 25 W AC-DC adapter
CB-MD4P4-RS	16 cm cable for 63000-FSP120AAB-RS 120 W AC-DC adapter
CB-NOLP4-RS	20 cm cable for terminal block DC input
32102-021500-200-RS	30 cm 20-pin ATX to 20-pin ATX cable

1

Industrial Computing Solutions

2

Video Capture Solutions

3

Industrial Computer Chassis

4

Open Frame Monitor

5

Power Supply/ Peripherals

6

All-in-One System

IDD-241100

100 W DC/DC Converter Module

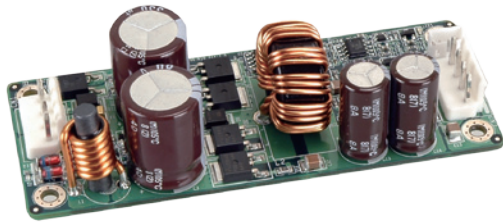

Features

1. 100W total power
2. AT mode on/off
3. Up to 90% efficiency
4. RoHS compliant
5. Compact size

Specifications

- Output (max.): 12 V@8.33 A
- Max. total output: 100 W
- Input: 24 VDC
- Performance characteristics
 - Noise & ripple: <240 mV
 - Load regulation: <240 mV
 - Efficiency: Up to 90%
- Dimensions (mm): 40 x 100
- Weight (NW): 60 g
- Operating temperature: -20°C ~ 70°C

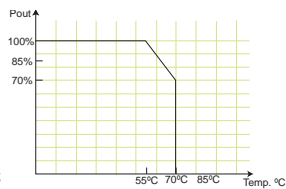

Wire Harness Selection Guide

DC Input (CN1)

PN: **CB-NOLP4-RS**
Cable for terminal block



Power On/off (CN1)

PN: **CB-JST3PSW-RS**
Cable with on/off switch



Dimensions (Unit: mm)

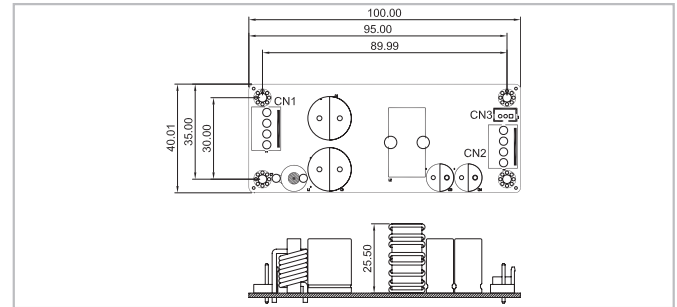

Packing Information

1 x IDD-241100 1 x QIG

Ordering Information

Part No.	Description
IDD-241100-R10	100 W DC/DC 24 V input, 12 V output with 100W total power
CB-JST3PSW-RS	30 cm cable on/off switch
CB-NOLP4-RS	20 cm cable for terminal block DC input

Pin Assignments

Input Power Connector

CN1	Pin 1	Pin 2	Pin 3	Pin 4
	VIN	VIN	GND	GND

Output Power Connector

CN2	Pin 1	Pin 2	Pin 3	Pin 4
	+12 V	+12V	GND	GND

Power on/off, LED Connector

CN3	Pin 1	Pin 2	Pin 3
	SHDN# (Shut down output power function, short Pin1 & Pin2)	GND	LEDA (Disable LED function, short Pin2 & Pin3)

1 Industrial Computing Solutions

2 Video Capture Solutions

3 Industrial Computer Chassis

4 Open Frame Monitor

5 Power Supply/Peripherals

6 All-in-One System

IDD-936160

60 W DC/DC Converter Module



IDD-936160 60W DC/DC Converter Module is a high performance buck-boost switching regulator power module. The constant frequency current mode architecture allows a phaselockable frequency of up to 400 kHz. With a wide 9V to 36V input and 12V output and seamless transfers between operating modes, the IDD-936160 is ideal for embedded systems with limited space.

Features

1. Wide input range: 9-36 VDC
2. 12 VDC output up to 5 Amp
3. Compact size
4. Efficiency up to 95%
5. RoHS compliant

Specifications

- Output (max.): 12 V@5 A
- Max. total output: 60 W
- Input: 9 VDC to 36 VDC
- Performance characteristics
 - Noise & ripple: <300 mV
 - Line regulation: <300 mV
 - Load regulation: <85 mV
 - Efficiency up to 95%
- Dimensions (mm): 82 x 25
- Weight (NW): 28 g
- Operating temperature: -40°C ~ 85°C

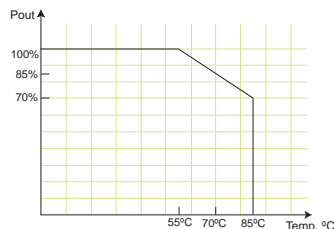

Dimensions (Unit: mm)

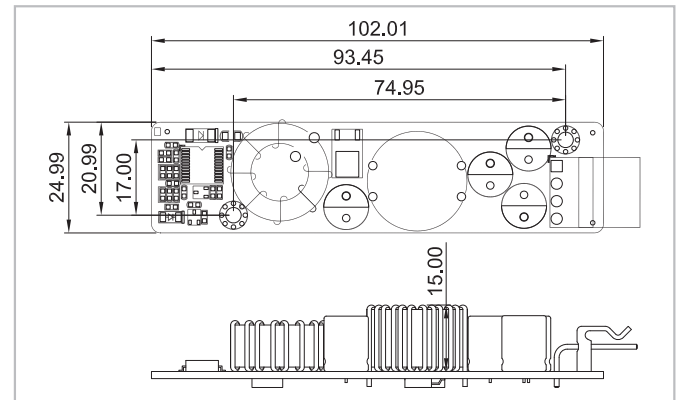

Pin Assignments

Input/Output Connector

VOUT1	Pin1	Pin2	Pin3
	+12 V Output	GND	Vin



P/N: 32102-015700-100-RS

Packing Information

1 x IDD-936160 1 x QIG
1 x 300 mm wire cable (P/N: 32102-015700-100-RS)

Ordering Information

Part No.	Description
IDD-936160-R20	60 W DC/DC 9-36 V input, 12 V output

PM-P006UPS

65 W DC/DC Converter Module, with UPS

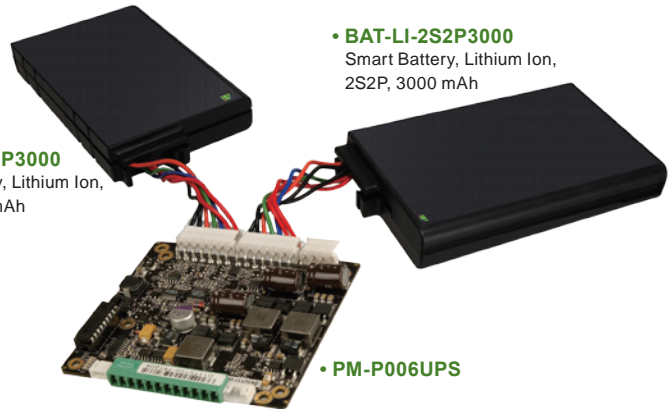
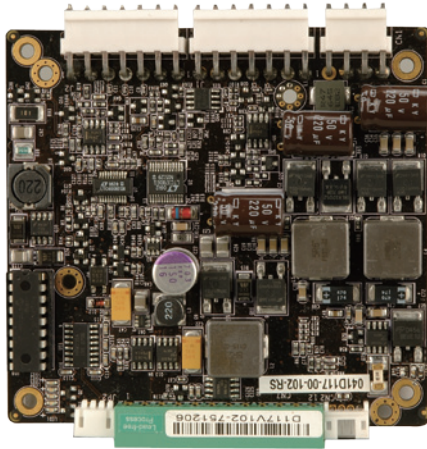

• **BAT-LI-2S2P3000**
Smart Battery, Lithium Ion,
2S2P, 3000 mAh

• **BAT-LI-2S2P3000**
Smart Battery, Lithium Ion,
2S2P, 3000 mAh

• **PM-P006UPS**

Features

1. Load down protection
2. Over voltage protection
3. Short circuit protection
4. Over current protection
5. Smart battery charger for lithium ion
6. I/O interface: SMBus/I²C & RS-232
7. Support up to two battery packs
8. AT/ATX modes
9. Utility program: pull data out through RS-232 to a system

Specifications

- Output (max.): 12 V@4 A, 5 V@10 A, 3.3 V@8 A, 5VSB@1 A, & -12 V @0.1 A
- Max. total output: 65 W
- Input: 6 VDC to 36 VDC
- Battery charge voltage: 12 V ~ 36 V
- Efficiency: up to 90%
- Dimensions (mm): 90 x 96
- Weight (NW): 178 g
- Operating temperature: -20°C ~ 85°C (without smart battery)
Operating temperature: -10°C ~ 60°C (with smart battery)
- Storage temperature: -35°C ~ 95°C

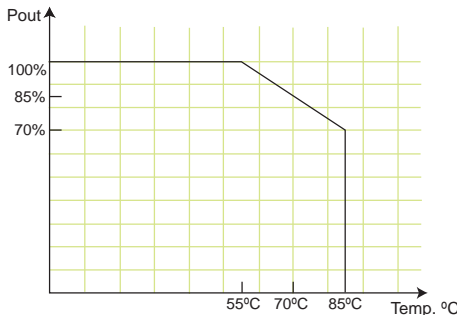

Applications



Battery backup system



Portable equipment



Power sensitive equipment

Dimensions (Unit: mm)

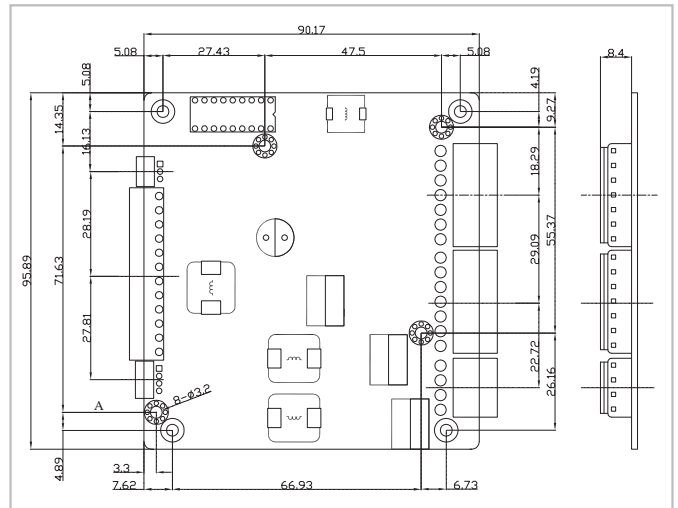

Packing Information

- 1 x PM-P006UPS
- 1 x QIG
- 1 x Utility CD
- 1 x DB-9 pin connector cable (32100-157200-RS)

Ordering Information

Part No.	Description
PM-P006UPS-R10	65 W ATX DC/DC 6-36 VDC input, 12 V, 5 V, 3.3 V, -12 V and 5VSB PC/104 power module with UPS
BAT-LI-2S2P3000-R10	Smart Battery, lithium ion, 2S2P, 3000 mAh
CB-JST3PSW001-RS	30 cm power on/off switch cable
CB-P1LP4-RS	20 cm cable for FSP0601AD101C 60 W/UP0451E12P 45 W/UP0251E12PL 25 W AC-DC adapter
CB-MD4P4-RS	16 cm cable for 63000-FSP120AAB-RS 120 W AC-DC adapter
CB-NOLP4-RS	20 cm cable for terminal block DC input

1

Industrial Computing Solutions

2

Video Capture Solutions

3

Industrial Computer Chassis

4

Open Frame Monitor

5

Power Supply/Peripherals

6

All-in-One System

High Energy Density, Light Weight and Compact DC/DC UPS & Power Module

- Protects your precious equipment from damage
- Reduces the risk of losing your valuable data

An uninterruptible power supply provides emergency backup power when the main power is lost.

Benefits:

- Provides power for a certain amount of time after a power failure has occurred
- Provides stable power to equipment during line sags and spikes
- Absorbs power surges and transients
- Smooths out noisy power sources

The utility software displays the following information:

- Current power source
- Battery status
- Charging status
- Remaining battery percentage



Battery Capacity Status

Level 2 Smart Battery Charger & Power Modules

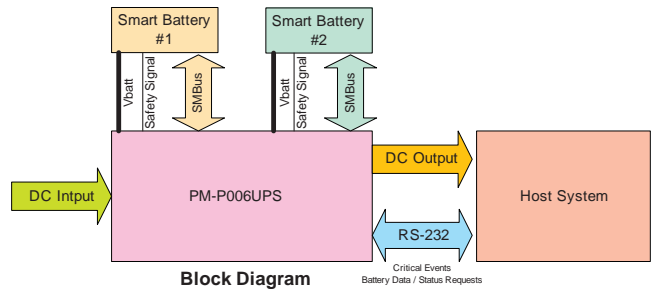

Block Diagram

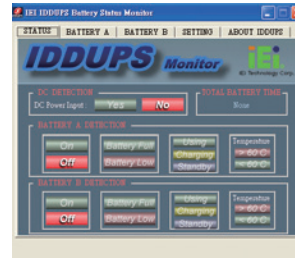

Battery Monitoring Utility



Battery Monitoring Connection Cable (PN: 32100-157200-RS)

Battery Pack (P/N: BAT-LI-2S2P3000)



Battery Type	Lithium Ion			
Pout (W)	100	80	60	40
Time (min.)	8	14	18	27
Dimensions (mm)	148 x 89 x 20			
Capacity	3000 mAh			

Pin Assignments

Input Power Connector

CN1	Pin 1	Pin 2	Pin 3	Pin 4
	VIN	VIN	Gnd	Gnd

I/O Interface RS-232 Connector

JP2	Pin 1	Pin 2	Pin 3
	Gnd	TX	RX

Output Power Connector

CN7	Pin 1	Pin 2	Pin 3	Pin 4	Pin 5	Pin 6	Pin 7	Pin 8	Pin 9	Pin 10	Pin 11	Pin 12
	N12V	Gnd	12 V	Gnd	3 V	3 V	Gnd	5 V	5 V	Gnd	5 VSB	Gnd

ATX Mode Connector

CN2	Pin 1	Pin 2	Pin 3	Pin 4
	PWROK	5 VSB	Gnd	PS_ON

Battery Connector

J1, J2	Pin 1	Pin 2	Pin 3	Pin 4	Pin 5	Pin 6	Pin 7
	BAT+	BAT+	Clock	Data	Temp	Gnd	Gnd

Wire Harness Selection Guide

DC Input



Option 1.
PN: CB-P1LP4-RS
 Cable for FSP0601AD101C 60 W / UP0451E12P 45 W/UP0251E12PL 25 W AC-DC adapter



Option 2.
PN: CB-MD4P4-RS
 Cable for 63000-FSP120AAB-RS 120 W AC-DC adapter



Option 3.
PN: CB-NOLP4-RS
 Cable for terminal block

Power On/Off



PN: CB-JST3PSW001-RS
 Cable to SBC (power ok & 5VSB)
 Pin 1 = Power ok
 Pin 2 = 5VSB
 Pin 3, 4 = Connector switch

IDD-930160-KIT

60 W DC/DC Converter Module for AFOLUX Panel PC and Monitor



Specifications

- Input voltage: 9-30 VDC
- Input current: Max. 8.2 A at 9 VDC
- Output: 12 V@5 A
- Max. total output: 60W
- Performance characteristics:
Noise and ripple: <120 mV
Line regulation: <2.5%
Load regulation: <2.5%
- Transient toggle rate: 250 Hz (50% duty ratio)
- Transient current step:
From 0% to 50% and 50% to 100% of max. current
- Efficiency: typ. 95% (Vin=12 V, 80% of full load)
- Dimensions (mm): 42 x 103 x 31
- Mounting kit: 12 mm x 80 mm
- Cable length: 180 cm
- Operating temperature: -10°C ~ 55°C
- Load down protection

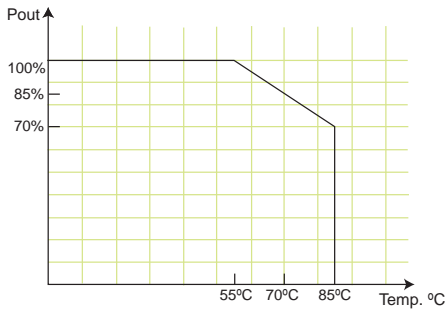

Typical Applications

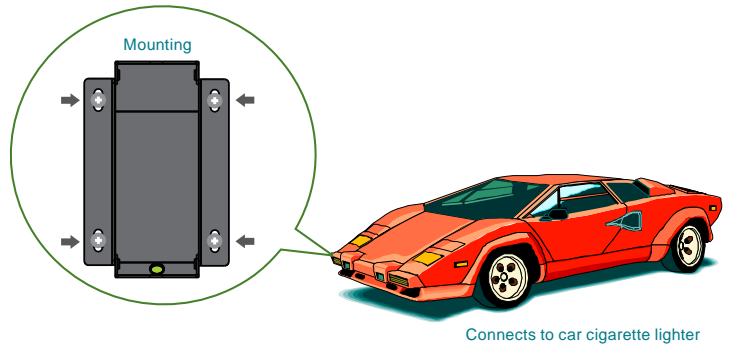

Dimensions (Unit: mm)

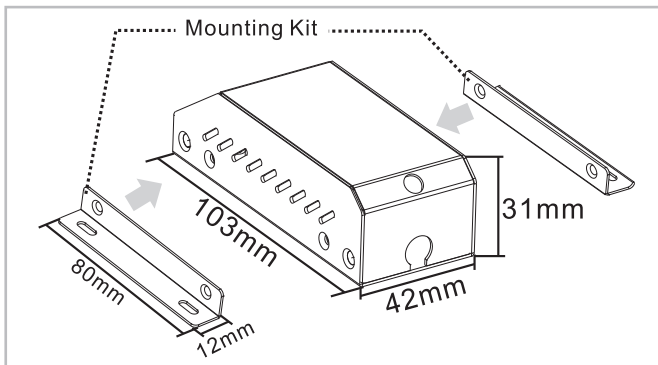

Packing Information

- 1 x IDD-930160-KIT-R20
- 1 x Mounting kit
- 1 x Screw kit
- 1 x Anti-slip strip
- 1 x Utility CD

Ordering Information

Part No.	Description
IDD-930160-KIT-R20	60 W DC/DC 9-30 VDC input vehicle power adapter

1

Industrial Computing Solutions

2

Video Capture Solutions

3

Industrial Computer Chassis

4

Open Frame Monitor

5

Power Supply/ Peripherals

6

All-in-One System

IDD-936260A

60 W DC/DC Converter Module

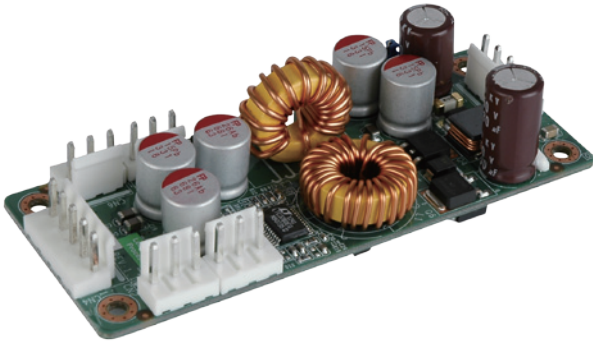

Features

1. Wide input range: 9-36 VDC
2. AT or ATX mode on/off
3. Up to 90% efficiency
4. RoHS compliant
5. Compact size

Dimensions (Unit: mm)

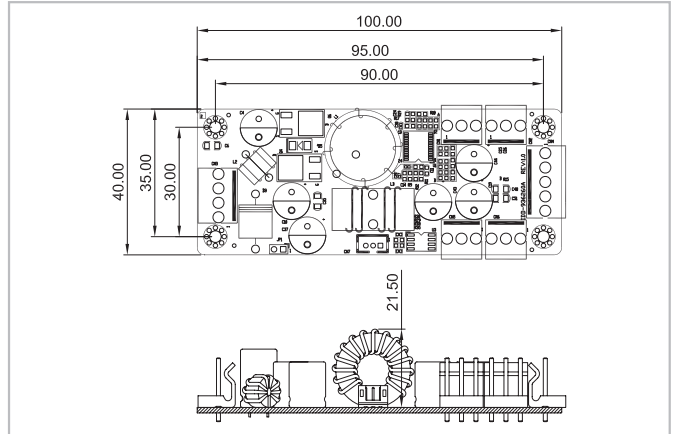

Specifications

- Output (max.): 12 V@3 A, 5 V@10 A & 5VSB@0.5 A
- Max. total output: 60 W
- Input: 9 VDC to 36 VDC
- Performance characteristics
 - Noise & ripple: <240 mV
 - Line regulation: <50 mV
 - Load regulation: <100 mV
 - Efficiency: Up to 90%
- Dimensions (mm): 40 x 100
- Weight (NW): 58 g
- Operating temperature: -20°C ~ 70°C

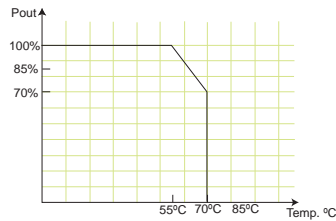

Packing Information

1 x IDD-936260A

1 x QIG

Ordering Information

Part No.	Description
IDD-936260A-R11	60 W DC/DC 9-36 V input, 12 V, 5 V & 5VSB output
CB-5PSBC-RS	20 cm cable to SBC power input
CB-JST3PSW-RS	30 cm cable on/off switch
CB-JST3P001-RS	30 cm 5VSB, PS_ON wire to SBC
CB-3PSATA-RS	10 cm cable for SATA power
CB-3PIDE-RS	10 cm cable for IDE HDD power
CB-P1LP4-RS	20 cm cable for FSP0601AD101C 60 W/UP0451E12P 45 W/UP0251E12PL 25 W AC-DC adapter
CB-MD4P4-RS	16 cm cable for 63000-FSP120AAB-RS 120 W AC-DC adapter
CB-NOLP4-RS	20 cm cable for terminal block DC input

Pin Assignments

Input Power Connector

CN3	Pin 1	Pin 2	Pin 3	Pin 4
	VIN	VIN	GND	GND

Output Power Connector

CN4	Pin 1	Pin 2	Pin 3	Pin 4	Pin 5
	+5 V	+5 V	GND	GND	+12 V

CN1 CN2 CN5 CN6	Pin 1	Pin 2	Pin 3
	+5 V	GND	+12 V

ATX Mode Connector

CN7	Pin 1	Pin 2	Pin 3
	5VSB	GND	PS_ON

Wire Harness Selection Guide

DC Input (CN3)

Option 1.

PN: CB-P1LP4-RS

Cable for FSP0601AD101C 60 W/UP0451E12P 45 W/UP0251E12PL 25 W AC-DC adapter

Option 2.

PN: CB-MD4P4-RS

Cable for 63000-FSP120AAB-RS 120 W AC-DC adapter

Option 3.

PN: CB-NOLP4-RS

Cable for terminal block

I/O Power (CN1, CN2, CN5 & CN6)

Option 1.

PN: CB-3PSATA-RS

Cable for SATA

Option 2.

PN: CB-3PIDE-RS

Cable for IDE HDD or any STD 4 pins I/O devices

SBC Main Power (CN4)

PN: CB-5PSBC-RS

5-pin connector to DC/DC power modules CN4

12 V only connector for NANO series SBC

Cable for SATA HDD



Power On/Off (CN7)

Option 1.

PN: CB-JST3PSW-RS

Cable with on/off switch

Option 2.

PN: CB-JST3P001-RS

Cable to SBC (5VSB & PS_ON)



1

Industrial Computing Solutions

2

Video Capture Solutions

3

Industrial Computer Chassis

4

Open Frame Monitor

5

Power Supply/ Peripherals

6

All-in-One System

IDD-12250A

50 W+60 W DC/DC Converter Module



Specifications

- Output (max.): 12 V@5 A (pass thru), 5 V@10 A & 5VSB@0.5 A
Max. total output: 50 W plus 60 W (12 V pass through)
- Input: 12 VDC
- Performance characteristics
Noise & ripple: <25 mV
Load regulation: <120 mV
Efficiency: Up to 90%
- Dimensions (mm): 40 x 100
- Weight (NW): 46 g
- Operating temperature: 0°C ~ 70°C

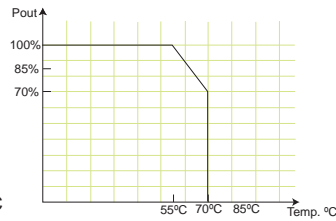

Features

1. 50 W + 60 W (12 V pass thru), total power 110 W
2. AT or ATX mode on/off
3. Up to 90% efficiency
4. RoHS compliant
5. Compact size

Dimensions (Unit: mm)

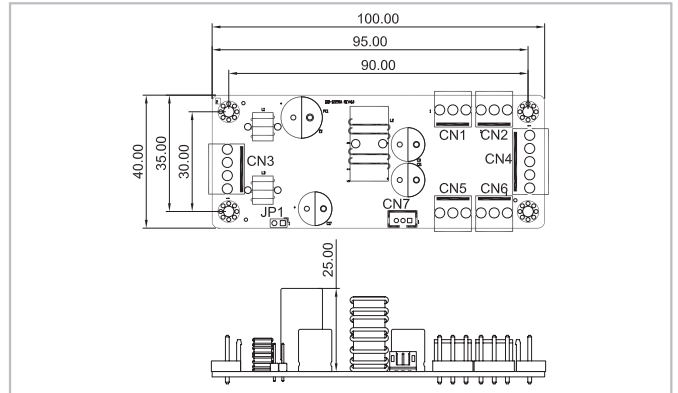

Packing Information

1 x IDD-12250A

1 x QIG

Ordering Information

Part No.	Description
IDD-12250A-R11	50 W+60 W DC/DC 12 V input, 12 V, 5 V & 5VSB output
CB-5PSBC-RS	20 cm cable to SBC power input
CB-JST3PSW-RS	30 cm cable on/off switch
CB-JST3P001-RS	30 cm 5VSB, PS_ON wire to SBC
CB-3PSATA-RS	10 cm cable for SATA power
CB-3PIDE-RS	10 cm cable for IDE HDD power
CB-P1LP4-RS	20 cm cable for FSP0601AD101C 60 W/UP0451E12P 45 W/UP0251E12PL 25 W AC-DC adapter
CB-MD4P4-RS	16 cm cable for 63000-FSP120AAB-RS 120 W AC-DC adapter
CB-NOLP4-RS	20 cm cable for terminal block DC input

Pin Assignments

Input Power Connector

CN3	Pin 1	Pin 2	Pin 3	Pin 4
	VIN	VIN	GND	GND

Output Power Connector

CN4	Pin 1	Pin 2	Pin 3	Pin 4	Pin 5
	+5 V	+5 V	GND	GND	+12V

CN1 CN2 CN5 CN6	Pin 1	Pin 2	Pin 3
	+5V	GND	+12V

ATX Mode Connector

CN7	Pin 1	Pin 2	Pin 3
	5VSB	GND	PS_ON

Wire Harness Selection Guide

DC Input (CN3)

Option 1.

PN: **CB-P1LP4-RS**

Cable for FSP0601AD101C 60 W/
UP0451E12P 45 W/UP0251E12PL
25 W AC-DC adapter

Option 2.

PN: **CB-MD4P4-RS**

Cable for 63000-FSP120AAB-RS
120 W AC-DC adapter

Option 3.

PN: **CB-NOLP4-RS**

Cable for terminal block

I/O Power (CN1, CN2, CN5 & CN6)

Option 1.

PN: **CB-3PSATA-RS**

Cable for SATA

Option 2.

PN: **CB-3PIDE-RS**

Cable for IDE HDD or any STD 4
pins I/O devices

SBC Main Power (CN4)

PN: **CB-5PSBC-RS**

5-pin connector to DC/DC
power modules CN4

12 V only connector for
NANO series SBC

Cable for SATA HDD

Std 4-pin 12 V, 5 V
I/O connector for WAFER,
NOVA, Enano series SBC
or I/O devices

Power On/Off (CN7)

Option 1.

PN: **CB-JST3PSW-RS**

Cable with on/off switch

Option 2.

PN: **CB-JST3P001-RS**

Cable to SBC (5VSB & PS_ON)

1

Industrial
Computing
Solutions

2

Video
Capture
Solutions

3

Industrial
Computer
Chassis

4

Open
Frame
Monitor

5

Power Supply/
Peripherals

6

All-in-One
System