

Industrial Motherboard Selection Guide

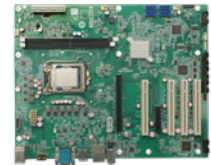

Model Name	IMBA-R680	IMBA-Q470	IMBA-Q471	IMBA-H420
CPU Socket	LGA1700	LGA1200	LGA1200	LGA1200
CPU Type	12th/13th generation Intel® Core™ i9/i7/i5/i3, Pentium® and Celeron® Processor	10th/11th generation Intel® Core™ i9/i7/i5/i3, Pentium® and Celeron® processor	10th/11th Generation LGA1200 Intel® Core™ i9/i7/i5/i3, Celeron® and Pentium® processors	10th/11th generation Intel® Core™ i9/i7/i5/i3, Celeron® and Pentium® processor
Chipset	Intel® R680E	Intel® Q470/Q470E	Intel® Q470/Q470E	Intel® H420E
Memory	Four 288-pin 4800 MHz dual-channel DDR5 SDRAM unbuffered DIMMs (ECC & non-ECC support) (system max.128GB)	Four 288-pin 2933 MHz dual-channel DDR4 SDRAM unbuffered DIMMs (system max. 128 GB)	Four 288-pin 2933 MHz dual-channel DDR4 SDRAM unbuffered DIMMs (system max. 128 GB)	Two 288-pin 2933 MHz dual-channel DDR4 SDRAM unbuffered DIMMs (system max.64GB)
Display Interface	Triple independent display 1 x DisplayPort 1 x HDMI 1 x IEI IDPM 3040 slot (only for IEI eDP/LVDS/VGA module)	Triple independent display 1 x VGA 1 x DisplayPort 1 x HDMI	Triple independent display 1 x VGA 1 x DisplayPort 1 x HDMI	Triple display 1 x VGA 1 x Internal DP++ 1 x HDMI
Ethernet	LAN1: Intel® I225V 2.5GbE controller LAN2: Intel® I225V 2.5GbE controller	LAN1: Intel® I225V 2.5GbE controller LAN2: Intel® I225V 2.5GbE controller	LAN1: Intel® I225V 2.5GbE controller LAN2: Intel® I225V 2.5GbE controller LAN3: Intel® I225V 2.5GbE controller	LAN1: Intel® I225V GbE controller
I/O Interface	4 x USB 3.2 Gen 2 (Type-A) 2 x USB 3.2 Gen 1 (Type-A) 2 x RS-232/422/485 (RS-485 support AFC) 4 x USB 2.0 pin header 2 x USB 3.2 Gen1 pin header 4 x RS-232 pin header	2 x USB 2.0 1 x RS-232/422/485 2 x RS-232 2 x USB 3.2 Gen 1 (Type-A) 2 x USB 3.2 Gen 2 (Type-A) 1 x RS-232/422/485 pin header 2 x RS-232 pin header 2 x USB 3.2 Gen 1 pin header 5 x USB 2.0 pin header	2 x USB 3.2 Gen 2 (Type-A) 2 x USB 3.2 Gen 1 (Type-A) 2 x USB 2.0 (Type-A) 1 x RS-232	4 x USB 3.1 Gen 1 (Type-A) 2 x USB 2.0 (Type-A) 1 x RS-232 1 x KB/MS 1 x RS-232/422/485 pin header 2 x USB 2.0 pin header 4 x RS-232 pin header
Storage Interface	6 x SATA 6Gb/s (RAID 0/1/5/10 supported) 2 x M.2 (M Key, support NVMe SSD)	4 x SATA 6Gb/s (RAID 0/1/5/10 supported)	5 x SATA 6Gb/s (RAID 0/1/5/10 supported) 1 x M.2 (M Key, support NVMe SSD)	4 x SATA 6Gb/s (no RAID)
Audio	1 x IAUDIO, support IEI AC-KIT-888S Audio Module (2 x 5 pin)	Realtek ALC888S HD Audio codec		
Digital I/O	12-bit programmable I/O (12-bit GPIO is for programming I/O)	8-bit programmable I/O (8-bit GPIO is for programming I/O)	12-bit programmable I/O (12-bit GPIO is for programming I/O)	8-bit programmable I/O (8-bit GPIO is for programming I/O)
Power Consumption	TBD	3.3V@1.36A, 5V@14.16A, 12V@7.5A (Intel® Core™ i9-10900E CPU with four 32 GB 3200 MHz DDR4 memory)	3.3V@1.1A, 5V@3.359A, 12V@2.18A, 5VSB@0.12A (Intel® Core™ i5-10500TE CPU with four 8 GB 2933 MHz DDR4 DIMMs)	3.3V@0.84A, 5V@8.12A, 12V@3.77A, 5VSB@0A (Intel® Core™ i5-10500TE CPU with two 32 GB 2933 MHz DDR4 memory, EuP mode enabled)
Watchdog Timer	Software programmable and supports 1~255 sec. system reset			
Operation Environment	Temperature Range: 0°C ~ 60°C (32°F ~ 140°F) Relative Humidity: 5% ~ 95%, non-condensing			
Expansion Slot	1 x M.2 M Key 1 x M.2 M Key 2 x PCIe Gen5 x16 with x8 Signal 3 x PCIe Gen4 x4 open-end 2 x PCIe Gen3 x1	1 x M.2 A Key 1 x M.2 M Key 1 x PCIe Gen3 x16 3 x PCIe Gen3 x4 3 x PCI	1 x M.2 M Key 2 x PCIe Gen3 x16 with x8 Signal 3 x PCIe Gen3 x4 open-end 2 x PCIe Gen3 x1	1 x PCIe Gen3 x16 1 x PCIe Gen3 x4 4 x PCI
CPU Cooler	TBD	CF-115XA-R10 CF-1156C-R20 CF-1156D-R30 CF-115XE-R10	CF-115XA-R10 CF-1156C-R20 CF-1156D-R30 CF-115XE-R10	CF-115XA-R10 CF-1156C-R20 CF-1156D-R30 CF-115XE-R10

Industrial Motherboard Selection Guide

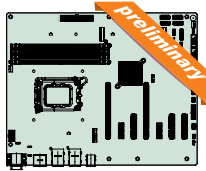
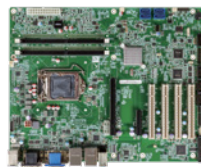

Model Name	IMBA-C2460	IMBA-Q370	IMBA-H310	IMBA-C2360-i2	IMBA-Q170-i2
CPU Socket	LGA1151	LGA1151	LGA1151	LGA1151	LGA1151
CPU Type	8th/9th generation Intel® Xeon® E, Core™ i9/i7/i5/i3, Pentium® and Celeron® processor	8th/9th generation Intel® Core™ i9/i7/i5/i3, Pentium® and Celeron® processor	8th/9th generation Intel® Core™ i9/i7/i5/i3, Pentium® and Celeron® processor	6th/7th generation Intel® Xeon® E3 v5/v6, Core™ i3, Pentium®, Celeron® processor	6th/7th generation Intel® Core™ i7/i5/i3, Pentium® and Celeron® processor
Chipset	Intel® C246	Intel® Q370	Intel® H310	Intel® C236	Intel® Q170
Memory	Four 288-pin 2666/2400 MHz dual-channel DDR4 SDRAM unbuffered DIMMs (ECC & non-ECC support) (system max. 64 GB)	Four 288-pin 2666/2400 MHz dual-channel DDR4 SDRAM unbuffered DIMMs (system max. 64 GB)	Two 288-pin 2666/2400 MHz dual-channel DDR4 SDRAM unbuffered DIMMs (system max. 64 GB)	Four 288-pin 2133 MHz dual-channel DDR4 SDRAM unbuffered DIMMs (ECC & non-ECC support) (system max. 64 GB)	Four 288-pin 2133 MHz dual-channel DDR4 SDRAM unbuffered DIMMs (system max. 64 GB)
Display Interface	Triple independent display 1 x VGA 1 x DP++ 1 x HDMI 1 x Internal DisplayPort 90°	Triple independent display 1 x VGA 1 x DP++ 1 x HDMI 1 x Internal DisplayPort 90°	Triple independent display 1 x DVI-D 1 x VGA 1 x Internal 180° Type-C DP	Triple independent display 1 x HDMI 2.0 1 x DVI-D 1 x VGA 1 x iDP interface	Triple independent display 1 x HDMI 2.0 1 x DVI-D 1 x VGA 1 x iDP interface
Ethernet	LAN1: Intel® I219LM PCIe controller LAN2: Intel® I211AT PCIe controller	LAN1: Intel® I219LM PCIe controller LAN2: Intel® I211AT PCIe controller	LAN1: Intel® I219LM with Intel® AMT 11.0 support LAN2: Intel® I211 AT PCIe controller	LAN1: Intel® I219LM with Intel® AMT 11.0 support LAN2: Intel® I210-AT PCIe controller with NCSI support	LAN1: Intel® I219LM with Intel® AMT 11.0 support LAN2: Intel® I210-AT PCIe controller with NCSI support
I/O Interface	2 x USB 3.2 Gen 2 (Type-A) 2 x USB 3.2 Gen 1 (Type-A) 1 x PS/2 KB/MS 2 x USB 2.0 1 x RS-232 1 x KB/MS pin header 2 x RS-232/422/485 pin header 3 x RS-232 pin header 2 x USB 3.2 Gen 1 pin header 4 x USB 2.0 pin header	2 x USB 3.2 Gen 2 (Type-A) 2 x USB 3.2 Gen 1 (Type-A) 1 x PS/2 KB/MS 2 x USB 2.0 1 x RS-232 1 x KB/MS pin header 2 x RS-232/422/485 pin header 3 x RS-232 pin header 2 x USB 3.2 Gen 1 pin header 4 x USB 2.0 pin header	1 x LPT 1 x RS-232/422/485 (RS-485 support AFC) 2 x KB/MS 4 x USB 2.0 4 x USB 3.2 Gen 1 5 x RS-232	1 x KB/MS 2 x USB 2.0 4 x USB 3.2 Gen 1 Type A 1 x KB/MS pin header 4 x RS-232 pin header 1 x LPT pin header 4 x USB 2.0 pin header 2 x USB 3.2 Gen 1 pin header 2 x RS-232/422/485 pin header	1 x KB/MS 2 x USB 2.0 4 x USB 3.2 Gen 1 Type A 1 x KB/MS pin header 4 x RS-232 pin header 1 x LPT pin header 4 x USB 2.0 pin header 2 x USB 3.2 Gen 1 pin header 2 x RS-232/422/485 pin header
Storage Interface	6 x SATA 6Gb/s (RAID 0/1/5/10 supported) 1 x M.2 (M Key, support NVME SSD)	6 x SATA 6Gb/s (RAID 0/1/5/10 supported) 1 x M.2 (M Key, support NVME SSD)	4 x SATA 6Gb/s (no RAID)	6 x SATA 6Gb/s (RAID 0/1/5/10 supported)	6 x SATA 6Gb/s (RAID 0/1/5/10 supported)
Audio	Realtek ALC888S HD Audio codec				
Digital I/O	8-bit programmable I/O (8-bit GPIO is for programming I/O)				
Power Consumption	3.3V@0.38A, 5V@9.38A, 12V@6.23A, 5VSB@0.16A (Intel® Core™ i5-8500 3.0 GHz CPU with four 16 GB 2400 MHz DDR4 memory)	3.3V@1.65A, 5V@3.4A, 12V@8.58A, 5VSV@3.4A (Intel® Core™ i7-8700K up to 4.60 GHz CPU with 32GB 2600MHz DDR4 memory)	3.3V@0.39A, 5V@2.99A, 12V@3.08A, 5VSB@0.2A (Intel® Core™ i5-8500 up to 3.00 GHz CPU with 20 GB 2400/2133 MHz DDR4 memory)	3.3V@1.51A, 5V@3.31A, 12V@9.02A, 5VSB@3.7A (Intel® Xeon® E3-1275 v5 3.60 GHz CPU with 32 GB (four 8GB) 2133 MHz DDR4 memory)	3.3V@1.65A, 5V@3.4A, 12V@8.58A, 5VSB@0.22A (Intel® Core™ i7-6700K 4.0GHz CPU with 32 GB (four 4 GB) 2133 MHz DDR4 memory)
Watchdog Timer	Software programmable and supports 1~255 sec. system reset				
Operation Environment	Temperature Range: -20°C ~ 60°C (-4°F ~ 140°F) Relative Humidity: 5% ~ 95%, non-condensing				
Expansion Slot	1 x M.2 A Key 1 x M.2 M Key 2 x PCIe Gen3 x8 3 x PCIe Gen3 x4 2 x PCI	1 x M.2 A Key 1 x M.2 M Key 2 x PCIe Gen3 x8 3 x PCIe Gen3 x4 2 x PCI	1 x PCIe x16 (Gen3) 1 x PCIe x4 (Gen2) 4 x PCI	1 x Full-size PCIe Mini card (support mSATA) 2 x PCIe x8 (Gen3) 3 x PCIe x4 (Gen3) 2 x PCI	1 x Full-size PCIe Mini card (support mSATA) 2 x PCIe x8 (Gen3) 3 x PCIe x4 (Gen3) 2 x PCI
CPU Cooler	CF-115XA-R10 CF-1156C-R20 CF-1156D-R30 CF-115XE-R10	CF-115XA-R10 CF-1156C-R20 CF-1156D-R30 CF-115XE-R10	CF-115XA-R10 CF-1156C-R20 CF-1156D-R30 CF-115XE-R10	CF-115XA-R10 CF-1156C-R20 CF-1156D-R30 CF-115XE-R10	CF-115XA-R10 CF-1156C-R20 CF-1156D-R30 CF-115XE-R10

Industrial Motherboard Selection Guide

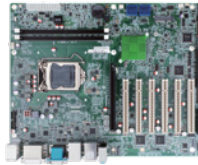
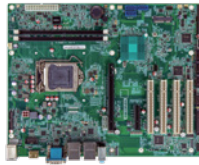

Model Name	IMBA-H112	IMBA-H110	IMBA-C2260-i2-R11	IMBA-Q870-i2
CPU Socket	LGA1151	LGA1151	LGA1150	LGA1150
CPU Type	6th/7th generation Intel® Core™ i7/i5/i3, Celeron® and Pentium® processor	6th/7th generation Intel® Core™ i7/i5/i3, Celeron® and Pentium® processor	4th generation Intel® Xeon® E3, Core™ i3, Pentium®, Celeron® processor	Intel® Core™ i7/i5/i3, Pentium®, Celeron® processor
Chipset	Intel® H110	Intel® H110	Intel® C226	Intel® Q87
Memory	Two 288-pin 2133 MHz dual-channel DDR4 SDRAM unbuffered DIMMs (system max. 64 GB)	Two 288-pin 2133 MHz dual-channel DDR4 SDRAM unbuffered DIMMs (system max. 64 GB)	Four 240-pin 1600/1333 MHz dual-channel DDR3 & DDR3L SDRAM ECC and non-ECC unbuffered DIMMs (system max. 32 GB)	Four 240-pin 1600/1333 MHz dual-channel DDR3 & DDR3L SDRAM unbuffered DIMMs (system max. 32 GB)
Display Interface	Dual independent display support 1 x VGA 1 x HDMI 1 x iDP interface	Dual independent display support 1 x DVI-I 1 x HDMI 1 x iDP interface	Dual display support 1 x VGA 1 x iDP interface	Triple display support 1 x VGA 1 x DVI-D 1 x HDMI 1 x iDP interface
Ethernet	LAN1: Intel® I219V PHY LAN2: Intel® I211 PCIe controller	LAN1: Intel® I219V PHY LAN2: Intel® I211 PCIe controller	LAN1: Intel® I217LM with Intel® AMT 9.0 support LAN2: Intel® I210-AT PCIe controller with NCSI support	LAN1: Intel® I217LM with Intel® AMT 9.0 support LAN2: Intel® I210-AT PCIe controller with NCSI support
I/O Interface	1 x KB/MS 4 x USB 3.2 Gen 1 Type A 2 x USB 2.0 1 x RS-232 1 x KB/MS pin header 1 x RS-232/422/485 pin header 1 x LPT pin header 1 x internal USB 2.0 (type A) 4 x RS-232 pin header 2 x USB 2.0 pin header	1 x KB/MS 4 x USB 3.2 Gen 1 Type A 2 x USB 2.0 2 x RS-232 1 x KB/MS pin header 2 x RS-232 pin header 1 x LPT pin header 2 x USB 2.0 pin header 1 x RS-232/422/485 pin header 1 x internal USB 2.0 (type A)	1 x KB/MS 4 x USB 2.0 2 x RS-232 4 x USB 3.2 Gen 1 Type A 1 x KB/MS pin header 1 x RS-422/485 pin header 1 x LPT pin header 4 x RS-232 pin header 4 x USB 2.0 pin header	1 x KB/MS 2 x USB 3.2 Gen 1 Type A 1 x RS-232 4 x USB 2.0 1 x KB/MS pin header 2 x USB 3.2 Gen 1 pin header 1 x LPT pin header 4 x RS-232 pin header 4 x USB 2.0 pin header 1 x RS-422/485 pin header
Storage Interface	3 x SATA 6Gb/s	4 x SATA 6Gb/s	6 x SATA 6Gb/s (RAID 0/1/5/10 supported) 1 x mSATA (colay SATA port 6) (support SATA 6Gb/s signal only)	6 x SATA 6Gb/s (RAID 0/1/5/10 supported) 1 x mSATA (colay SATA port 6) (support SATA 6Gb/s signal only)
Audio	Realtek ALC888S HD Audio codec			
Digital I/O	N/A	8-bit programmable I/O (8-bit GPIO is for programming I/O)		
Power Consumption	3.3V@1.53A, 5V@2.95A, 12V@8.38A, 5VSB@3.2A (4.0 GHz Intel® Core™ i7-6700K CPU with two 8 GB 2133 MHz DDR4 memory)	3.3V@1.53A, 5V@2.95A, 12V@8.38A, 5VSB@3.2A (Intel® Core™ i7 6700K 4.0GHz CPU with 16GB (two 8GB) 2133 MHz DDR4 memory)	3.3V@0.57A, 5V@4.50A, 12V@0.14A, Vcore_12V@5.20A, 5VSB@0.19A (Intel® E3-1240 v3 3.4GHz CPU with 16 GB (four 4 GB) 1333 MHz DDR3 memory)	3.3V@0.66A, 5V@4.34A, 12V@0.16A, Vcore_12V@4.01A, 5VSB@0.21A (Intel® Core™ i7-4770K 3.90 GHz CPU with four 1333 MHz 4 GB DDR3 DDR3 memory)
Watchdog Timer	Software programmable and supports 1~255 sec. system reset			
Operation Environment	Temperature Range: -20°C ~ 60°C (-4°F ~ 140°F) Relative Humidity: 5% ~ 95%, non-condensing		Temperature Range: -10°C ~ 60°C (14°F ~ 140°F) Relative Humidity: 5% ~ 95%, non-condensing	
Expansion Slot	1 x Full-size PCIe Mini card (support mSATA) 1 x PCIe x16 (Gen3) 1 x PCIe x4 (Gen3) 4 x PCI	1 x Full-size PCIe Mini card (support mSATA) 1 x PCIe x16 (Gen3) 6 x PCI	1 x PCIe x16 slot 3 x PCIe x4 slot Default setting: 1 x PCIe x8, 2 x PCIe x4 Optional setting: 1 x PCIe x16 by BIOS setting 1 x PCIe x1 slot 2 x PCI slot	1 x PCIe x16 slot (Gen 3) 1 x PCIe x4 slot 1 x PCIe x1 slot 4 x PCI slots
CPU Cooler	CF-115XA-R10 CF-1156C-R20 CF-1156D-R30 CF-115XE-R10	CF-115XA-R10 CF-1156C-R20 CF-1156D-R30 CF-115XE-R10	CF-115XA-R10 CF-115XE-R10	CF-115XA-R10 CF-115XE-R10

Industrial Motherboard Selection Guide

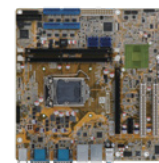
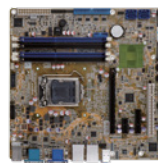
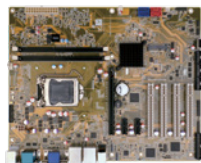

Model Name	IMBA-H810	IMB-H110	IMB-Q870-i2	IMB-H810-i2-R11
CPU Socket	LGA1150	LGA1151	LGA1150	LGA1150
CPU Type	4th generation Intel® Core™ i7/i5/i3 Pentium® and Celeron® processor	6th generation Intel® Core™ i7/i5/i3, Celeron® and Pentium® processor	Intel® Core™ i7/i5/i3, Pentium®, Celeron® processor	Intel® Core™ i7/i5/i3, Pentium®, Celeron® processor
Chipset	Intel® H81	Intel® H110	Intel® Q87	Intel® H81
Memory	Two 240-pin 1333/1600 MHz dual-channel DDR3 SDRAM unbuffered DIMM (system max. 16 GB)	Two 288-pin 2133MHz Dual-channel DDR4 SDRAM Unbuffered DIMM supported up to 64GB	Four 240-pin 1600/1333 MHz dual-channel DDR3 & DDR3L SDRAM unbuffered DIMMs (system max. 32 GB)	Two 240-pin 1600/1333 MHz dual-channel DDR3 & DDR3L SDRAM unbuffered DIMMs (system max. 16 GB)
Display Interface	Dual independent display support 1 x DVI-D 1 x VGA 1 x iDP interface	Dual independent display support 1 x VGA 1 x DVI-I 1 x LVDS 1 x iDP	Triple display support 1 x VGA 1 x DVI-D 1 x HDMI 1 x iDP interface	Triple display support 1 x VGA1 1 x VGA2 1 x iDP interface
Ethernet	LAN1: Intel® I217-LM with Intel® AMT 9.0 support LAN2: Intel® I211-AT PCIe controller	Dual LAN: RTL 8111GN controller	LAN1: Intel® I217LM with Intel® AMT 9.0 support LAN2: Intel® I210-AT PCIe controller with NCSI support	LAN1: Intel® I217LM LAN2: Intel® I210-AT PCIe controller with NCSI support
iRIS Remote Management Module	N/A	N/A	1 x iRIS-2400 slot	
I/O Interface	1 x KB/MS 2 x USB 2.0 2 x RS-232 2 x USB 3.2 Gen 1 Type A 1 x KB/MS pin header 1 x internal USB 2.0 (180° Type-A) 1 x LPT pin header 3 x RS-232 pin header 1 x RS-422/485 pin header 4 x USB 2.0 pin header 2 x SATA 6Gb/s 2 x SATA 3Gb/s	4 x USB 3.2 Gen 1 Type A 6 x USB 2.0 1 x KB/MS pin header 2 x RS-232/422/485 pin header 1 x LPT pin header 2 x USB 2.0 pin header 10 x RS-232pin header	1 x KB/MS 2 x USB 3.2 Gen 1 Type A 1 x RS-232 4 x USB 2.0 1 x KB/MS pin header 1 x RS-422/485 pin header 4 x RS-232 pin header 2 x USB 3.2 Gen 1 pin header 4 x USB 2.0pin header	1 x KB/MS 2 x USB 2.0 2 x RS-232 2 x USB 3.2 Gen 1 Type A 1 x LPT pin header 1 x RS-422/485 (pin header) 8 x RS-232 pin header 8 x USB 2.0 pin header
Storage Interface	2 x SATA 3Gb/s 2 x SATA 6Gb/s	4 x SATA 6Gb/s (RAID 0/1 supported)	4 x SATA 6Gb/s (RAID 0/1/5/10 supported)	2 x SATA 6Gb/s 2 x SATA 3Gb/s (AHCI supported)
Audio	Realtek ALC888S HD Audio codec			
Digital I/O	8-bit programmable I/O (8-bit GPIO is for programming I/O)	8-bit programmable digital I/O	8-bit programmable I/O (8-bit GPIO is for programming I/O)	N/A
Power Consumption	3.3V@0.83A, 5V@2.2A, 12V@3.88A, 5VSB@0.3A (Intel® Core™ i7-4770K 3.90 GHz CPU with 8 GB (two 4 GB) 1333 MHz DDR3 memory)	3.3V@ 0.93A, 5V@2.99A, 12V@6.88A, 5VSB@0.02A (Intel® Core™ i7-6700K 4.0GHz CPU with 16GB (two 8GB) 2133 MHz DDR4 memory)	3.3V@0.53A, 5V@4.96A, 12V@0.12A, Vcore_12V@3.95A, 5VSB@0.18A (Intel® Core™ i7-4770K 3.90 GHz CPU with 16 GB four 1333 MHz 4 GB DDR3 memory)	3.3V@0.64A, 5V@4.20A, 12V@0.14A, Vcore_12V@3.88A, 5VSB@0.20A (Intel® Core™ i7-4770K 3.90 GHz CPU with 8 GB two 1333 MHz 4 GB DDR3 memory)
Watchdog Timer	Software programmable and supports 1~255 sec. system reset			
Operation Environment	Temperature Range: -20°C ~ 60°C (-4°F~140°F) Relative Humidity: 5% ~ 95% non-condensing			
Expansion Slot	1 x PCIe x 16 2 x PCIe x 1 4 x PCI 1 x PCIe Mini (support mSATA)	1 x PCIe x16 (Gen3) 1 x Full-size PCIe Mini card 1 x PCIe x1 (Gen2) 2 x PCI	1 x PCIe x16 (Gen 3) 1 x PCIe x4 1 x PCIe x1 1 x PCI	1 x PCIe x16 (Gen 3) 1 x PCIe x1 2 x PCI
CPU Cooler	CF-115XA-R10 CF-115XE-R10	CF-115XA-R10 CF-115XE-R10	CF-115XA-R10 CF-115XE-R10	CF-115XA-R10 CF-115XE-R10

IMBA-R680

ATX motherboard supports LGA1700 12th/13th Generation Intel® Core™ i9/i7/i5/i3, Pentium® and Celeron® processor, DDR5, triple independent displays, dual 2.5GbE LAN, M.2, USB 3.2, SATA 6Gb/s, and RoHS

preliminary

Four 288-pin 4800 MHz Dual-channel DDR5 SDRAM Unbuffered DIMMs support up to 128GB (ECC & non-ECC supported)

LGA1700 socket supports 12th generation Alder Lake-S Intel® Core™ i9/i7/i5/i3/Pentium®/Celeron® Processor (up to 125W TDP CPU)

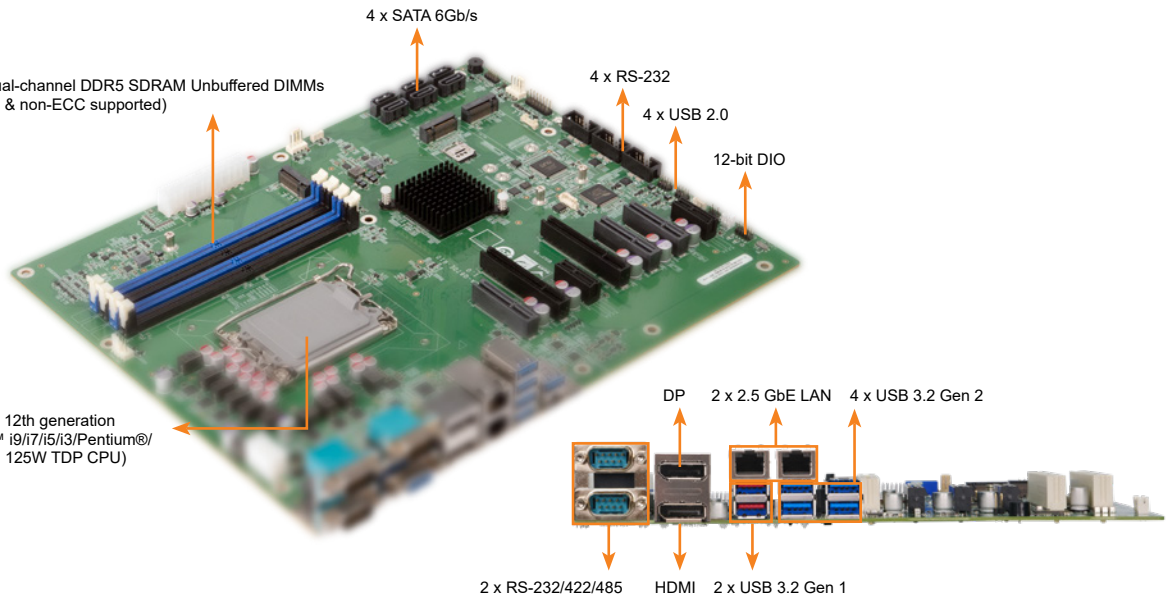

Four 288-pin 4800 MHz Dual-channel DDR5
(up to 128GB)

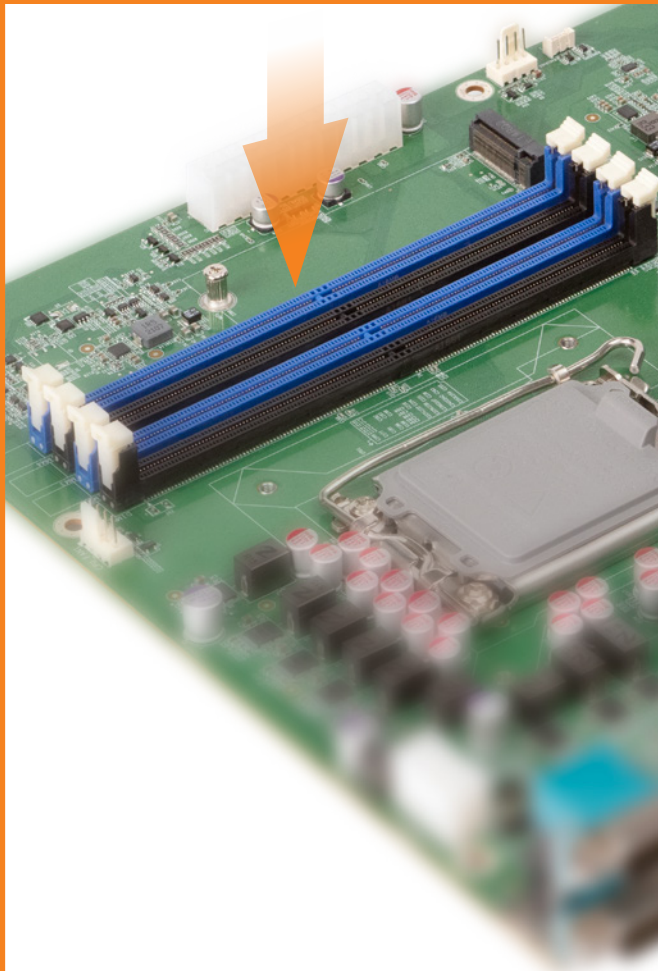

Features

- LGA1700 12th/13th Generation Intel® Core™ i9/i7/i5/i3, Pentium® and Celeron® processor (125W)
- Dual-channel DDR5 4800MHz
- Support DisplayPort 1.4a, HDMI & IDPM modules
- Support two M.2 M key for NVMe storage
- High-performance ATX motherboard with PCIe Gen4 & Gen5 expansion slots



Support 12th/13th Gen Intel® Core™ CPU

Support LGA1700 socket 12th/13th generation Alder Lake-S Intel® Core™ i9/i7/i5/i3, Pentium®, Celeron® processor (up to 125W TDP), up to 16 cores / 24 threads for outstanding multi-thread performance.



Support DDR5-4800MHz

The IMBA-R680 is designed to support four 288-pin 4800 MHz dual-channel DDR5 SDRAM unbuffered DIMMs (system max. 128GB, ECC & non-ECC supported).



Pure PCIe Expansion Slot

It supports two PCIe Gen5 x16 slots with x8 signals, three PCIe Gen4 x4 open-ended slots and two PCIe Gen3 x1 slots for installing multiple PCI Express cards.



Support Six SATA for Storage

It supports six SATA 6Gb/s and RAID 0/1/5/10. In addition, there are two M.2 M key with PCIe signal supporting NVMe storage.

Specifications

- ◆ CPU
LGA1700 socket supports 12th/13th generation Alder Lake-S Intel® Core™ i9/i7/i5/i3/ Pentium®/Celeron® Processor (up to 125W TDP CPU)
- ◆ Chipset
Intel® R680E
- ◆ BIOS
AMI UEFI BIOS
- ◆ Memory
Four 288-pin 4800 MHz dual-channel DDR5 SDRAM unbuffered DIMMs support up to 128GB (ECC & non-ECC supported)
- ◆ Graphics Engine
New Intel® Xe Graphics architecture with SRIOV, Genlock
- ◆ Display Output
Triple independent display
1 x DP (up to 4096 x 2304 @60Hz)
1 x HDMI (up to 4096 x 2304 @30Hz)
1 x IDPM IEI eDP/ LVDS/ VGA module
- ◆ Ethernet
LAN1: Intel® I225V 2.5GbE controller (colay I225-LM support vPro)
LAN2: Intel® I225V 2.5GbE controller (colay I225-LM support vPro)
- ◆ External I/O Interface
4 x USB 3.2 Gen 2 (Type-A) (10Gb/s)
2 x USB 3.2 Gen 1 (Type-A) (5Gb/s)
2 x RS-232/422/485 (RS-485 support AFC)
- ◆ Internal I/O Interface
6 x SATA 6Gb/s (RAID 0/1/5/10 supported)
4 x USB 2.0 (2x4 pin, P=2.54)
2 x USB 3.2 Gen 1 (2x10 pin, P=2.00, wafer) (5Gb/s)
4 x RS-232 (2x5 pin, P=2.54)
- ◆ SMBus
1 x SMBus (1x4 pin)
- ◆ I²C
1 x I²C (1x4 pin)
- ◆ Audio
1 x IAUDIO supports IEI AC-KIT-888S Audio Kit (2x5 pin)
- ◆ Front Panel
1 x Front Panel (2x7 pin, Power LED, HDD LED, Speaker, Power Button, Reset Button)
- ◆ LAN LED
2 x LAN LED (1x2 pin)
- ◆ Expansion
2 x PCIe Gen5 x16 slot with x8 Signal
3 x PCIe Gen4 x4 open-end
2 x PCIe Gen3 x1
1 x M.2 M Key (2242/2280, PCIe x4) NVMe supported
1 x M.2 M Key (2242/2280, PCIe x2 for SSD) NVMe supported
- ◆ Digital I/O
1 x 12-bit digital I/O (2x7 pin)
- ◆ TPM
Intel® PTT (TPM 2.0)
- ◆ Fan Connector
1 x CPU fan connector (1x4 pin)
2 x System fan connector (1x3 pin)
- ◆ Chassis Open
1 x Chassis intrusion (1x2 pin)
- ◆ Power Supply
ATX/AT power supply
Support AT/ATX mode
ErP/EuP Compliant
- ◆ Watchdog Timer
Software Programmable support 1~255 sec. System reset
- ◆ Power Consumption
TBD
- ◆ Operating Temperature
0°C~60°C
- ◆ Storage Temperature
-30°C ~ 70°C
- ◆ Operating Humidity
5% ~95%, non-condensing
- ◆ Dimensions
244mm x 305mm
- ◆ Weight
GW:1200g / NW:700g
- ◆ Certification
CE/FCC compliant

Dimensions (Unit: mm)

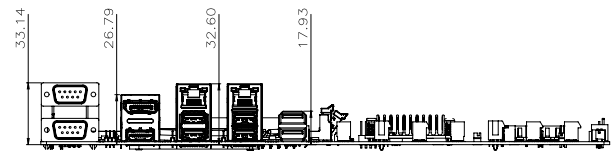
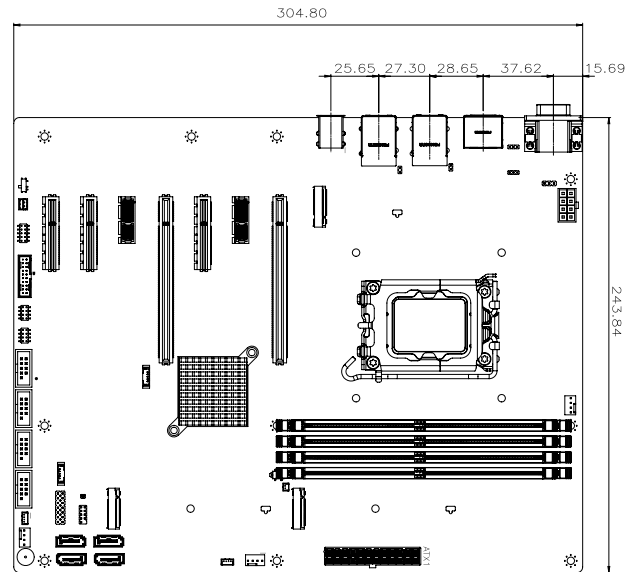

Packing List

1 x IMBA-R680 single board computer	1 x I/O shielding
2 x SATA cable	1 x QIG

Ordering Information

Part No.	Description
IMBA-R680-R10	ATX motherboard supports LGA1700 12th/13th Generation Intel® Core™ i9/i7/i5/i3, Pentium® and Celeron® processor, DDR5, triple independent displays, dual 2.5GbE LAN, M.2, USB 3.2, SATA 6Gb/s, and RoHS

Optional Accessories

Part No.	Description
AC-KIT-888S-R10	Realtek ALC888S 7.1 Channel HD Audio peripheral board, RoHS
CB-USB02-RS	Dual port USB cable with bracket, 300mm, P=2.54
19800-010500-200-RS	USB 3.0 cable 457mm with bracket
32102-000100-200-RS	SATA power cable, MOLEX 5264-4P to SATA15P
32205-000702-100-RS	RS-232 cable, 230mm, P=2.54



IMBA-Q470

ATX motherboard supports 10th/11th Generation Intel® Core™ i9/i7/i5/i3, Celeron® and Pentium® processor, DDR4 memory, triple independent display, dual 2.5GbE LAN, M.2, USB 3.2, SATA 6Gb/s, HD Audio and RoHS

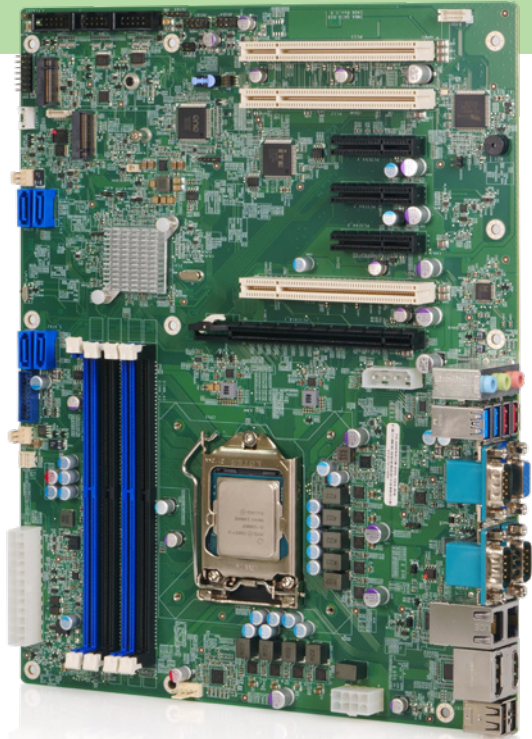
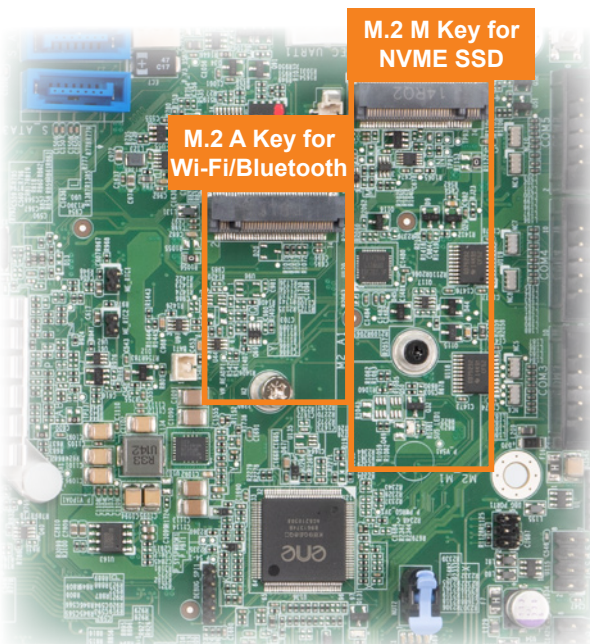
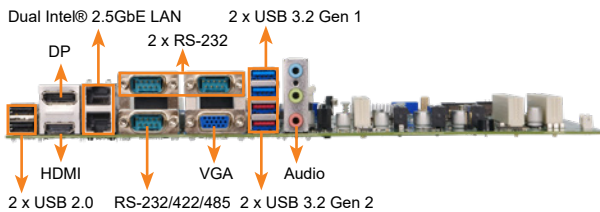
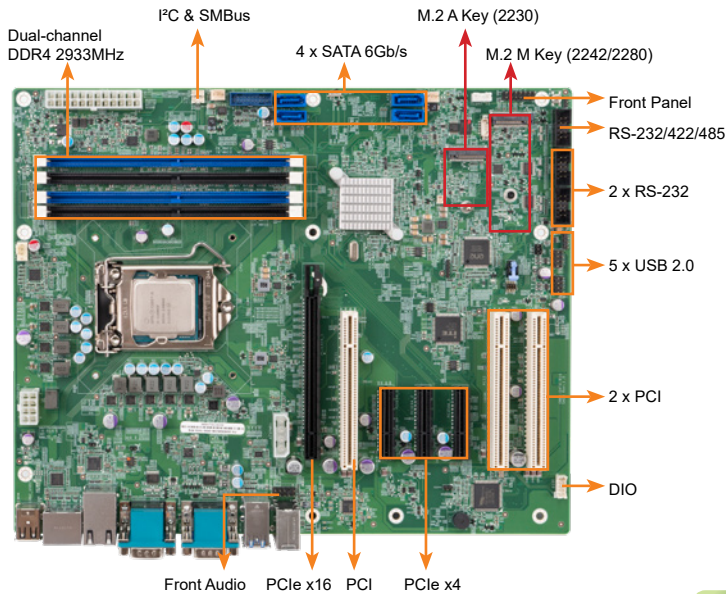

Features



Support 10th/11th Gen Intel® Core™ CPU

Built-in with 10th/11th Generation Intel® Core™ i9/i7/i5/i3, Celeron® and Pentium® processor (LGA1200), high performance capability with multi-tasking function



Support Intel® I225V 2.5GbE Controller

The IMBA-Q470 is designed with two 2.5 GbE LAN ports via Intel® I225V Ethernet Controllers



Rich Expansion I/O

It includes one PCIe x16, three PCIe x4 and three PCI slots for functional expansions like graphics cards, LAN cards or motion control cards. It also provides an M.2 A-key slot for Bluetooth and Wi-Fi, and an M.2 M-key for storage.



Support USB 3.2 Gen 1 and Gen 2, up to 10Gb/s

It supports USB 3.2 specification and is equipped with two USB 3.2 Gen 1 (5Gb/s) ports and two USB 3.2 Gen 2 (10Gb/s) ports. Additionally, two USB 3.2 Gen 1 ports and six USB 2.0 ports are supported via internal connectors.

Specifications

- ◆ CPU
LGA1200 socket supports 10th/11th generation Intel® Core™ i9/i7/i5/i3, Pentium® or Celeron® processor. up to 125W TDP
- ◆ Chipset
Intel® Q470/Q470E
- ◆ BIOS
AMI UEFI BIOS
- ◆ Memory
Four 288-pin 2933MHz dual-channel unbuffered DDR4 SDRAM DIMM slots (system max. 128GB)
- ◆ Graphics Engine
Intel® UHD Graphics 630
Intel® HD Graphics Gen9 Engines with 16 low-power execution units, supporting DX2015, OpenGL 5.X, OpenCL2.x and ES 2.0
- ◆ Display Output
Triple independent display
1 x VGA (up to 1920 x 1080@60Hz)
1 x DP (up to 4096 x 2304@60Hz)
1 x HDMI (up to 4096 x 2160@30Hz)
- ◆ Ethernet
LAN1: Intel® I225V 2.5GbE controller
LAN2: Intel® I225V 2.5GbE controller
- ◆ External I/O Interface
2 x USB 2.0
1 x RS-232/422/485 (RS-485 supports AFC)
2 x USB 3.2 Gen 1 (5Gb/s)
2 x RS-232
2 x USB 3.2 Gen 2 (10Gb/s)
- ◆ Internal I/O Interface
1 x RS-232/422/485 (2x5 pin, P=2.54) (RS-485 supports AFC)
2 x RS-232 (2x5 pin, P=2.54)
2 x USB 3.2 Gen 1 (2x10 pin, P=2.0) (5Gb/s)
4 x SATA 6Gb/s (supports RAID 0/1/5/10)
5 x USB 2.0 (2x4 pin, P=2.54)
- ◆ SMBus
1 x SMBus (1x4 pin)
- ◆ I²C
1 x I²C (1x4 pin)
- ◆ Audio
Realtek ALC888S HD Audio codec
3 x Audio jack (Line-in, Line-out, Mic-in)
1 x Analog audio (2x5 pin)
- ◆ Front Panel
1 x Front panel connector
(2x7 pin, power LED, HDD LED, speaker, power button, reset button)
- ◆ Expansions
1 x PCIe 3.0 x16 slot
1 x M.2 2230 A key (PCIe Gen3 x1, USB 2.0)
3 x PCIe 3.0 x4 slot
1 x M.2 2242/2280 M Key (PCIe Gen3 x4)
3 x PCI slot
- ◆ Digital I/O
1 x 8-bit digital I/O (2x5 pin)
- ◆ TPM
Support Intel® PTT (TPM 2.0)
- ◆ Fan Connector
1 x CPU fan connector (1x4 pin)
2 x System fan connector (1x3 pin)
- ◆ Chassis Intrusion
1 x Chassis intrusion (1x2 pin)
- ◆ Power Supply
ATX/AT power supply
Support AT/ATX mode
ErP/EuP compliant
- ◆ Watchdog Timer: Software programmable, support 1~255 sec. system reset
- ◆ Power Consumption: 3.3V@1.36A, 5V@14.16A, 12V@7.5A
(Intel® Core™ i9-10900E CPU with four 32 GB 3200 MHz DDR4 DIMMs)
- ◆ Operating Temperature: 0°C ~ 60°C
- ◆ Storage Temperature: -30°C ~ 70°C
- ◆ Operating Humidity: 5% ~ 95%, non-condensing
- ◆ Dimensions: 244mm x 305mm
- ◆ Weight: GW:1200g / NW:700g
- ◆ Certification: CE/FCC compliant

Dimensions (Unit: mm)

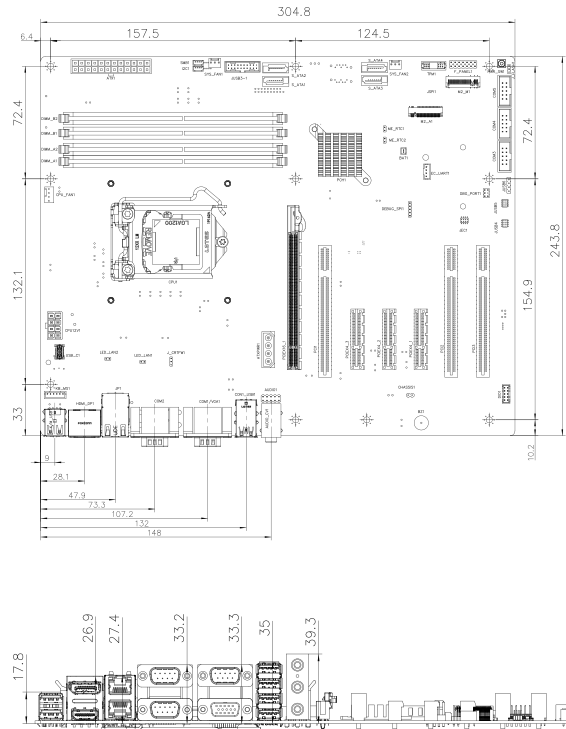

Packing List

1 x IMBA-Q470 single board computer	1 x I/O shielding
2 x SATA cable	1 x QIG

Ordering Information

Part No.	Description
IMBA-Q470-R10	ATX industrial motherboard supports 10th/11th Generation Intel® Core™ i9/i7/i5/i3, Celeron® and Pentium® processor, DDR4 memory, triple independent display, dual 2.5GbE LAN, M.2, USB 3.2, SATA 6Gb/s, HD Audio and RoHS

Optional Accessories

Part No.	Description
CB-USB02-RS	Dual port USB cable with bracket, 300mm, P=2.54
19800-010500-200-RS	USB 3.0/USB3.2 cable 450mm with bracket, P=2.0
19800-020100-100-RS	RS-232 cable, 230mm, P=2.54
32102-000100-200-RS	SATA power cable, MOLEX 8981-4M to SATA15P, 150MM
CF-115XA-R10	High-performance LGA1155/1156/1200 cooler kit, 1U chassis compatible 73W
CF-1156C-R20	LGA1155/1156/1200 cooler kit, 1U chassis compatible, 45W
CF-1156D-R30	LGA1155/1156/1200 cooler kit, 1U chassis compatible, 65W
CF-115XE-R10	High-performance LGA1155/1156/1200 cooler kit, 95W



IMBA-Q471

ATX Motherboard Supports 10th/11th Gen. LGA1200 Intel® Core™ i9/ i7/i5/i3, Celeron® and Pentium® Processors, DDR4, Triple Independent Displays, Triple 2.5GbE, M.2, USB 3.2, SATA 6Gb/s, HD Audio and RoHS

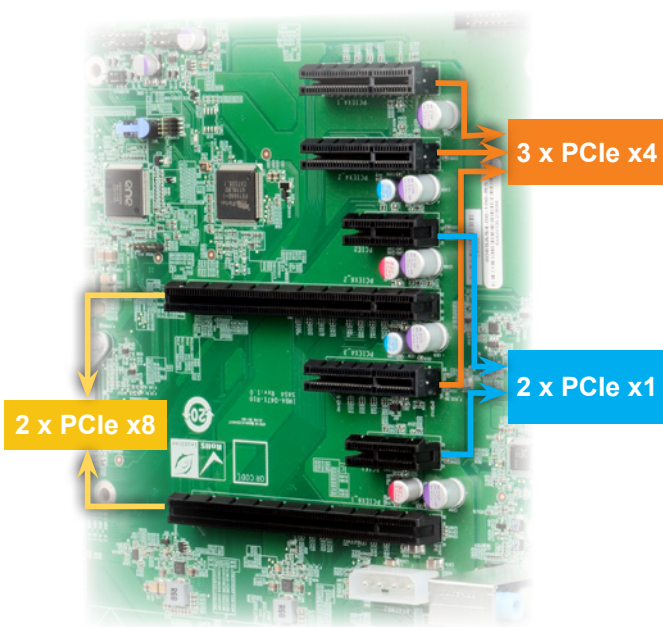
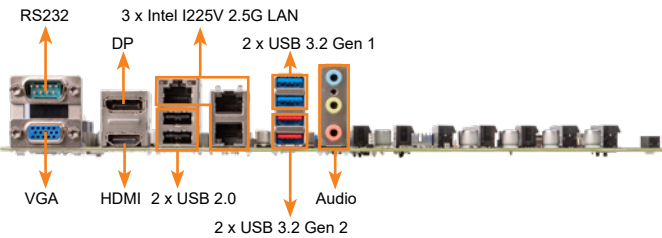
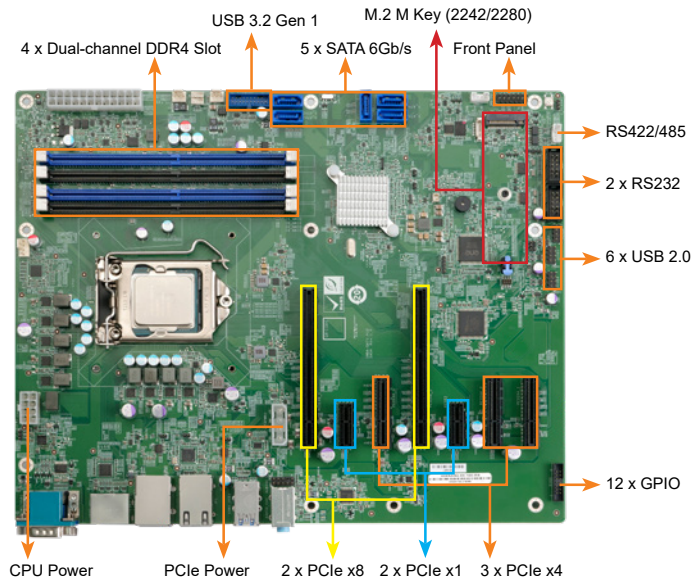

Features



Support 10th/11th Generation Intel® Processor

Support 10th/11th generation Intel® Core™ i9/i7/i5/i3, Celeron® and Pentium® processor (LGA 1200 slot) to provide superior performance and run multi-tasking.



Support Intel® I225V 2.5GbE Controller

The IMBA-Q471 is equipped with 3 Gigabit RJ45 network ports via Intel® I225V 2.5GbE network controllers to achieve up to 2.5GbE network transmission rate.

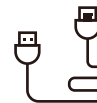

Support USB 3.2 Gen 1 / Gen 2 up to 10Gb/s

The design of the motherboard is based on USB 3.2 protocol. Two USB 3.2 Gen 1 (5Gb/s) and two USB 3.2 Gen 2 (10Gb/s) are provided through external I/O for faster data transfer rate. The IMBA-Q471 also has internal USB 3.2 Gen 1 and USB 2.0 ports for additional wiring options.



Full-featured PCIe Expansion Slot

The IMBA-Q471 features two PCIe Gen3 x16 slots that support PCIe Gen3 x8 signals, enabling it to accept two independent graphics cards at the same time. There are also three PCIe Gen3 x4 slots and two PCIe Gen3 x1 slots that support PCIe expansion cards such as network cards, sound cards or motion control cards.

Specifications

- ◆ CPU
 - 10th/11th Generation LGA1200 Intel® Core™ i9/i7/i5/i3, Celeron® and Pentium® processors
- ◆ Chipset
 - Intel® Q470/Q470E
- ◆ BIOS
 - AMI UEFI BIOS
- ◆ Memory
 - Four 288-pin 2933 MHz dual-channel unbuffered DDR4 SDRAM DIMM slots supporting up to 128 GB memory
- ◆ Graphics Engine
 - Up to Intel® UHD Graphics 630; Intel® HD Graphics Gen 9 Engines with 16 low-power execution units, supporting DX2015, OpenGL 5.x, OpenCL2.x and ES 2.0
- ◆ Display Output
 - Triple independent displays
 - 1 x VGA (up to 1920 x 1080 @ 60 Hz)
 - 1 x DP (up to 4096 x 2304 @ 60 Hz)
 - 1 x HDMI (up to 4096 x 2304 @ 30 Hz)
- ◆ Ethernet
 - LAN1: Intel® I225V 2.5GbE controller (Colay with I225-LM)
 - LAN2: Intel® I225V 2.5GbE controller (Colay with I225-LM)
 - LAN3: Intel® I225V 2.5GbE controller (Colay with I225-LM)
- ◆ External I/O Interface
 - 2 x USB 3.2 Gen 2 (10Gb/s) (Type-A)
 - 2 x USB 3.2 Gen 1 (5Gb/s) (Type-A)
 - 2 x USB 2.0 (Type-A)
 - 1 x RS-232
- ◆ Internal I/O Interface
 - 5 x SATA 6Gb/s (RAID 0/1/5/10 supported)
 - 6 x USB 2.0 (2x4 pin, P=2.54)
 - 2 x USB 3.2 Gen1 (2x10 pin, P=2.0)
 - 2 x RS-232 (2x5 pin, P=2.54)
 - 1 x RS-422/485 (1x4 pin, P=2.0)
- ◆ I²C
 - I²C (1x4 pin)
- ◆ SMBus
 - 1 x SMBus (1x4 pin)
- ◆ Audio
 - Realtek ALC888S HD codec supports 7.1-channel
 - 3 x Audio jacks (line-out, line-in, mic-in) on rear IO
 - 1 x Front audio (2x5 pin)
- ◆ Front Panel
 - 1 x Front Panel (2x7 pin, Power LED, HDD LED, Speaker, Power Button, Reset Button)
- ◆ LAN LED
 - 2 x LAN LED (1x2 pin)
- ◆ Expansion
 - 2 x PCIe Gen3 x16 (x8 signal)
 - 3 x PCIe Gen3 x4 open-end
 - 2 x PCIe Gen3 x1
 - M.2 M key (2240/2280) with PCIe x2 & SATA signal
- ◆ Digital I/O
 - 1 x 12-bit digital I/O (2x7 pin)
- ◆ TPM
 - Intel® PTT (TPM 2.0)
- ◆ Fan Connector
 - 1 x CPU fan connector (1x4 pin) / 2 x System fan connector (1x3 pin)
- ◆ Power Supply
 - ATX/AT power supply / Support AT/ATX mode / ErP/EuP Compliant
- ◆ Watchdog Timer
 - Software Programmable support 1~255 sec. System reset
- ◆ Power Consumption
 - 3.3V@1.1A, 5V@3.359A, 12V@2.18A, 5VSB@0.12A
 - (Intel® Core™ i5-10500TE CPU with four 8 GB 2933 MHz DDR4 DIMMs)
- ◆ Operating Temperature
 - 0°C ~ 60°C
- ◆ Storage Temperature
 - 30°C ~ 70°C
- ◆ Operating Humidity
 - 5% ~95%, non-condensing
- ◆ Dimensions
 - 244mm x 305mm
- ◆ Weight
 - GW:1200 g / NW:700 g
- ◆ Safety
 - CE/FCC compliant

Dimensions (Unit: mm)

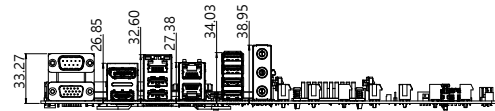
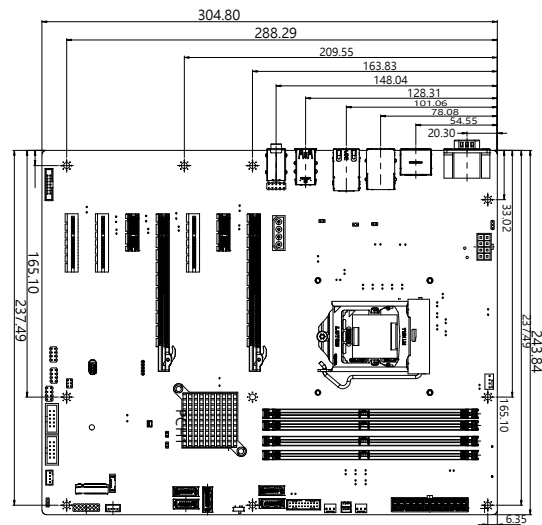

Packing List

1 x IMBA-Q471 single board computer	1 x I/O shielding
2 x SATA cable	1 x QIG

Ordering Information

Part No.	Description
IMBA-Q471-R10	ATX Motherboard Supports 10th/11th Gen. LGA1200 Intel® Core™ i9/i7/i5/i3, Celeron® and Pentium® Processors, DDR4, Triple Independent Displays, Triple 2.5GbE, M.2, USB 3.2, SATA 6Gb/s, HD Audio and RoHS

Optional Accessories

Part No.	Description
CB-USB02-RS	Dual port USB cable with bracket, 300mm, P=2.54
19800-010500-200-RS	USB 3.0/USB3.2 cable 450mm with bracket
32102-000100-200-RS	SATA power cable, MOLEX 5264-4P to SATA15P
19800-020100-100-RS	RS-232 cable (230mm) P=2.54
CF-115XA-R10	High performance LGA115x cooler kit for Intel Xeon/Core i7/i5/i3 CPU, 89x92.6x27.4, 1U chassis compatible, 73W, CCL, RoHS
CF-1156C-R20	Low power LGA1155/LGA1156 cooler kit for Intel CPU, 45W, CCL, RoHS
CF-1156D-R30	Low power LGA1155/LGA1156 cooler kit for Intel CPU, 65W, CCL, RoHS
CF-115XE-R10	High performance LGA115x cooler kit for Intel Xeon/Core i7/i5/i3 CPU, 91(L)x91(W)x84(H), 95W, CCL, RoHS



IMBA-H420

ATX motherboard supports 14nm LGA1200 Intel® 10th/11th Generation Intel® Core™ i9/i7/i5/i3, Celeron® and Pentium® processor, DDR4, Triple displays, 2.5GbE LAN, USB 3.2, SATA 6Gb/s, HD Audio and RoHS

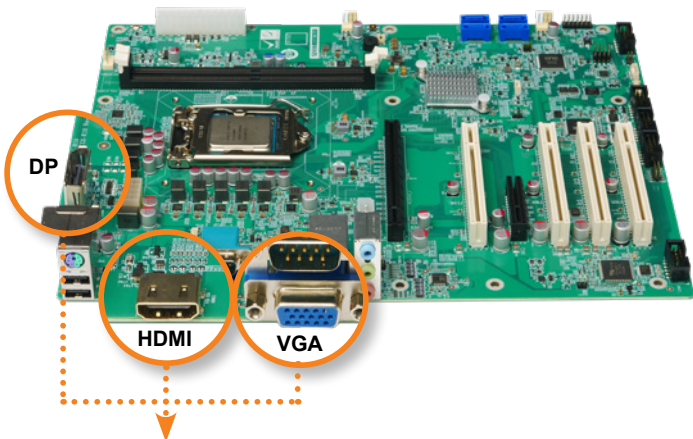
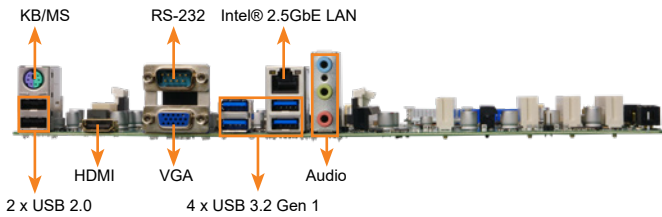
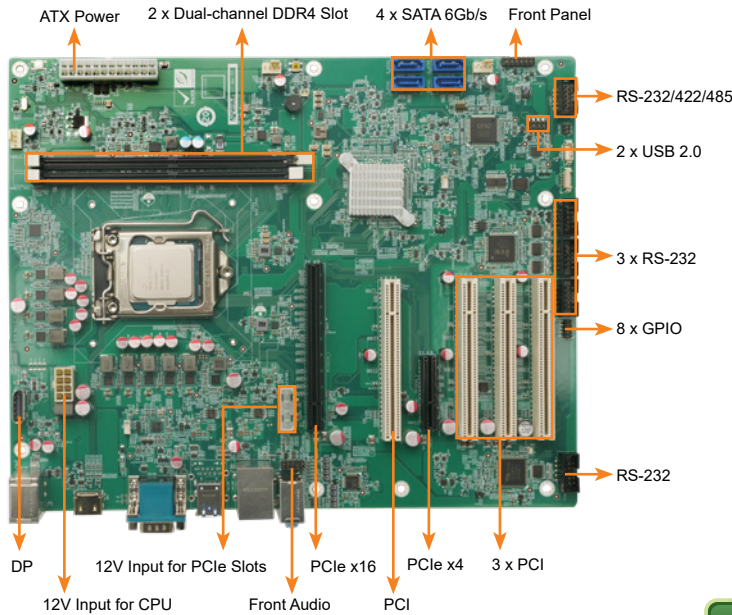

Triple Independent Displays

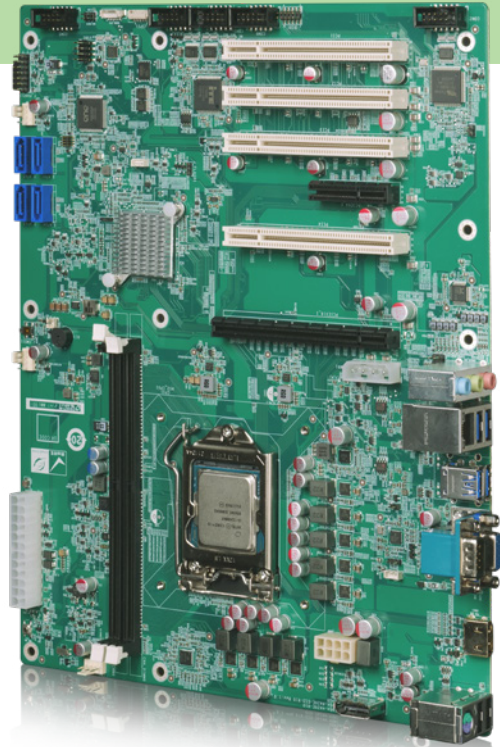

Features



Support 10th/11th Generation Intel® Processor

10th/11th generation Intel® Core™ i9/i7/i5/i3, Celeron® and Pentium® processors (LGA 1200 slot) are supported to provide superior performance and handle multiple tasks simultaneously.



Support Intel® I225V 2.5GbE Ethernet Controller

Support RJ45 network interface via Intel® I225v 2.5GbE network controller to achieve up to 2.5GbE network transmission rate.



Support Multiple Expansion Slots

The IMBA-H420 supports one PCIe Gen3 x16, one PCIe Gen3 x4 and four PCI slots for PCIe expansion cards such as graphics card, network cards and motion control cards.

Specifications

- ◆ CPU
LGA1200 socket supports 10th/11th Gen Intel® Core™ i9/i7/i5/i3, Celeron® and Pentium® processor
- ◆ Chipset
Intel® H420E
- ◆ BIOS
AMI UEFI BIOS
- ◆ Memory
Two 288-pin 2933 MHz dual-channel unbuffered DDR4 SDRAM DIMM slots supporting up to 64 GB memory
- ◆ Graphics Engine
Up to Intel® UHD Graphics 630; Intel® HD Graphics Gen 9 Engines with 16 low-power execution units, supporting DX2015, OpenGL 5.x, OpenCL2.x and ES 2.0
- ◆ Display Output
Triple display
1 x VGA (up to 1920 x 1200@60Hz)
1 x internal DP++ (up to 4096 x 2304@60Hz)
1 x HDMI (up to 4096 x 2160@30Hz)
- ◆ Ethernet
LAN1: Intel® i225-V GbE controller (colay i225-LM)
- ◆ External I/O Interface
4 x USB 3.1 Gen 1 (5Gb/s)
2 x USB 2.0
1 x RS-232
1 x KB/MS
- ◆ Internal I/O Interface
1 x RS-232/422/485 (2x5 pin, P=2.54)
2 x USB 2.0 (2x4 pin, P=2.54)
4 x RS-232 (2x5 pin, P=2.54)
4 x SATA 6Gb/s (no RAID)
- ◆ I²C
1 x I²C (1x4 pin)
- ◆ SMBus
1 x SMBus (1x4 pin)
- ◆ Audio
Realtek ALC888S HD codec
3 x Audio jack (Line-in, Line-out, Mic-in) on rear IO
1 x Front audio (2x5 pin)
- ◆ Front Panel
1 x Front Panel (2x7 pin, Power LED, HDD LED, Speaker, Power Button, Reset Button)
- ◆ LAN LED
1 x LAN LED (1x2 pin)
- ◆ Expansion
1 x PCIe Gen3 x16
1 x PCIe Gen3 x4
4 x PCI
- ◆ Digital I/O
1 x 8-bit digital I/O (2x5 pin)
- ◆ TPM
Intel® PTT (TPM 2.0)
- ◆ Fan Connector
1 x CPU fan connector (1x4 pin)
2 x System fan connector (1x4 pin)
- ◆ Chassis Open
1 x Chassis intrusion connector (1x2 pin)
- ◆ Power Supply
ATX/AT power supply
Support AT/ATX mode
ErP/EuP Compliant
- ◆ Watchdog Timer
Software Programmable support 1~255 sec. System reset
- ◆ Power Consumption
3.3V@0.84A, 5V@8.12A, 12V@3.77A, 5VSB@0A (Intel® Core™ i5-10500TE CPU with two 32 GB 2933 MHz DDR4 memory, EuP mode enabled)
- ◆ Operating Temperature
0°C ~ 60°C
- ◆ Storage Temperature
-30°C ~ 70°C
- ◆ Operating Humidity
5% ~95%, non-condensing
- ◆ Dimensions
244mm x 305mm
- ◆ Weight
GW:1200g / NW:700g

Dimensions (Unit: mm)

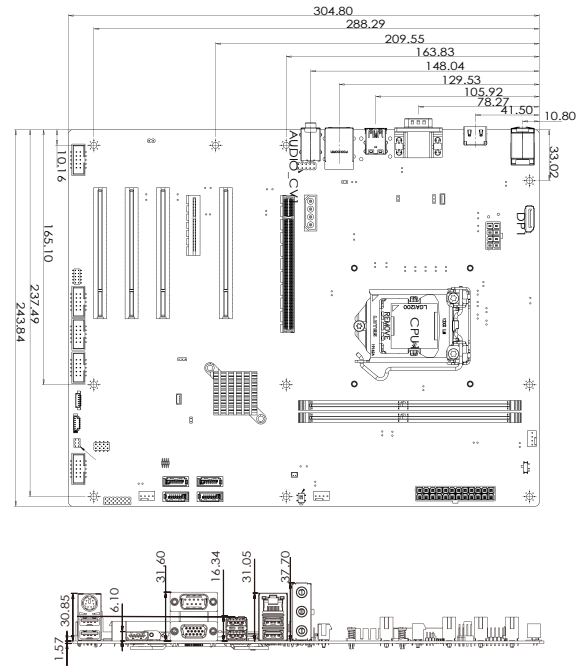

Packing List

1 x IMBA-H420 single board computer	1 x I/O shielding
2 x SATA cable	1 x QIG

Ordering Information

Part No.	Description
IMBA-H420-R10	ATX motherboard supports 14nm LGA1200 Intel® 10th/11th Generation Core™ i9/i7/i5/i3, Celeron® and Pentium® processor, DDR4, Triple displays, 2.5GbE LAN, USB 3.2, SATA 6Gb/s, HD Audio and RoHS
IMBA-H420-ECO-R10	ATX motherboard supports 14nm LGA1200 Intel® 10th/11th Generation Core™ i9/i7/i5/i3, Celeron® and Pentium® processor, DDR4, Triple displays, 2.5GbE LAN, USB 3.2, SATA 6Gb/s, HD Audio ECO packing and RoHS

Optional Accessories

Part No.	Description
CB-USB02-RS	Dual port USB cable with bracket, 300mm, P=2.54
19800-020100-100-RS	RS-232 cable 230mm P=2.54
32205-000702-200-RS	RS-232 cable, 230mm, P=2.54
32102-000100-200-RS	SATA power cable, MOLEX 5264-4P to SATA15P
CF-115XA-R10	LGA1155/1156 cooler kit, 1U chassis compatible, 73W
CF-1156C-R20	LGA1155/LGA1156 cooler kit, 1U chassis compatible, 45W
CF-1156D-R30	LGA1155/LGA1156 cooler kit, 1U chassis compatible, 65W
CF-115XE-R10	High-performance LGA1155/1156 cooler kit, 95W



IMBA-C2460

ATX motherboard supports 14nm LGA1151 Intel® 8th/9th Generation Xeon® E, Core™ i9/i7/i5/i3, Celeron® and Pentium® processor per Intel® C246, DDR4, triple displays, dual GbE LAN, M.2, USB 3.2, SATA 6Gb/s, HD Audio and RoHS

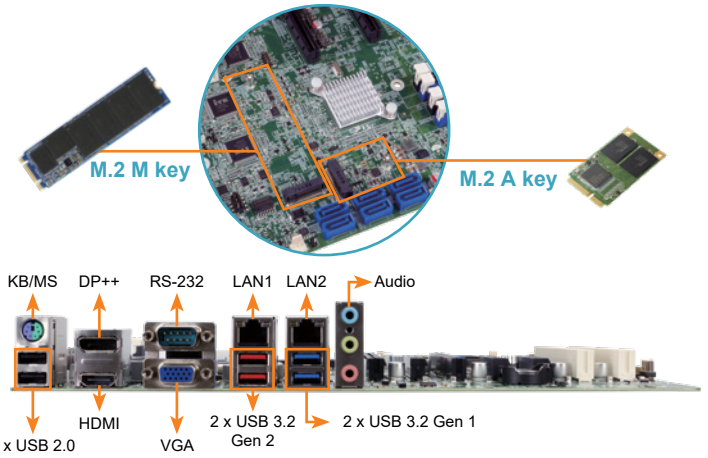
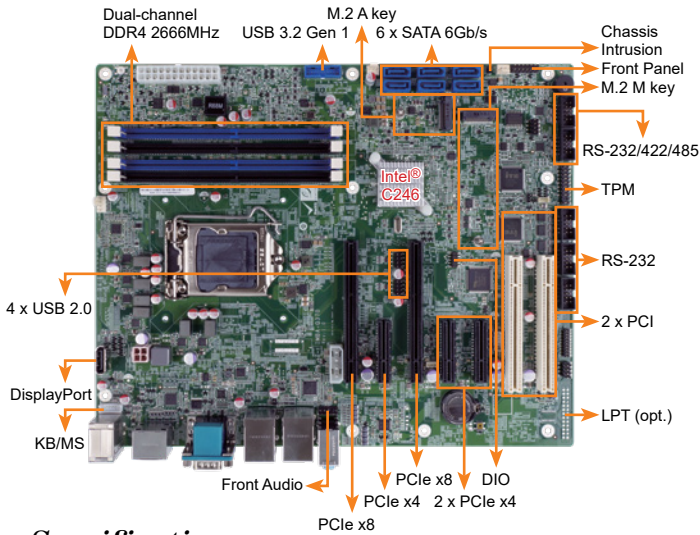

Specifications

- ◆ CPU
LGA1151 Intel® 8th/9th Generation Xeon® E, Core™ i9/i7/i5/i3, Celeron® and Pentium® processor
- ◆ Chipset: Intel® C246
- ◆ BIOS: AMI UEFI BIOS
- ◆ Memory
Four 288-pin 2666/2400 MHz Dual-channel DDR4 SDRAM Unbuffered DIMMs supported up to 64GB (ECC&non-ECC support)
- ◆ Graphics Engine
Intel® HD Graphics Gen 9 Engines with Low power 16 execution unit, supports DX2015, OpenGL 5.X and OpenCL2.x, ES 2.0
- ◆ Display Output
Triple independent display
1 x VGA (up to 1920 x 1080@60Hz)
1 x DP++ (up to 4096 x 2304@60Hz)
1 x HDMI (up to 4096 x 2304@30Hz)
1 x Internal DisplayPort (up to 4096 x 2304@60Hz)
- ◆ Ethernet
LAN1: Intel® I219LM PCIe controller with AMT 11.0 support
LAN2: Intel® I210AT PCIe controller
- ◆ External I/O Interface
2 x USB 3.2 Gen 2 (10Gb/s) 1 x RS-232
2 x USB 3.2 Gen 1 (5Gb/s) 1 x PS/2 KB/MS
2 x USB 2.0
- ◆ Internal I/O Interface
1 x 180° Displayport 1 x KB/MS (1x6 pin, P=2.0)
2 x RS-232/422/485 (2x5 pin, P=2.54) 3 x RS-232 (2x5 pin, P=2.54)
2 x USB 3.2 Gen 1 (5Gb/s) (2x10 pin, P=2.0) 4 x USB 2.0 (2x4 pin, P=2.54)
6 x SATA 6Gb/s (RAID 0/1/5/10 supported)
- ◆ SMBus: 1 x SMBus (1x4 pin)
- ◆ I²C: 1 x I²C (1x4 pin)
- ◆ Audio
Realtek ALC888S HD Audio codec
3 x Audio Jack (Line-in, Line-out, Mic-in)
1 x Analog audio (2x5 pin)
- ◆ Front Panel
1 x Front Panel (2x7 pin, Power LED, HDD LED, Speaker, Power Button, Reset Button)
- ◆ LAN LED
2 x LAN LED (1x2 pin)
- ◆ Expansion
2 x PCIe x8 1 x M.2 A key (2230, PCIe x1 & USB 2.0)
3 x PCIe x4 1 x M.2 M Key (2280, PCIe x2 only)
2 x PCI
- ◆ Digital I/O: 1 x 8-bit digital I/O (2x5 pin)
- ◆ TPM: 1 x TPM (2x10 pin)
- ◆ Fan Connector
1 x CPU fan connector (1x4 pin)
2 x System fan connector (1x3 pin)
- ◆ Chassis Open: 1 x Chassis intrusion (1x2 pin)
- ◆ Power Supply
ATX/AT power supply
Support AT/ATX mode
ErP/EuP Compliant
- ◆ Watchdog Timer: Software Programmable support 1~255 sec. system reset
- ◆ Power Consumption
3.3V@0.38A, 5V@9.38A, 12V@6.23A, 5VSB@0.16A
(3.0 GHz Intel® Core™ i5-8500 CPU with four 16 GB 2400 MHz DDR4 memory)
- ◆ Operating Temperature: -20°C ~ 60°C
- ◆ Storage Temperature: -30°C ~ 70°C
- ◆ Operating Humidity: 5% ~ 95%, non-condensing
- ◆ Dimensions: 244mm x 305mm
- ◆ Weight: GW:1200g / NW:700g
- ◆ CE/FCC compliant



Features

- LGA1151 Intel® 8th/9th Generation Xeon® E, Core™ i9/i7/i5/i3, Celeron® and Pentium® processor
- Dual-channel DDR4 2666MHz
- Support VGA, HDMI & DP++
- Support M.2 A key for WLAN expansion, M key for storage

Packing List

1 x IMBA-C2460 single board computer	2 x SATA cable
1 x I/O shielding	1 x QIG

Dimensions (Unit: mm)

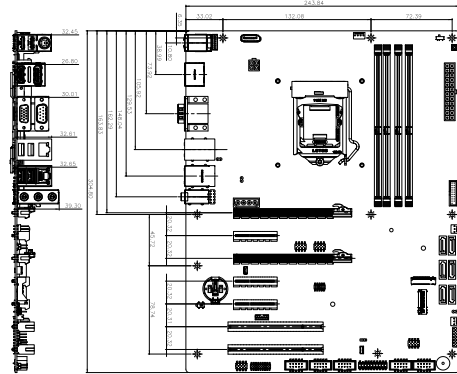

Ordering Information

Part No.	Description
IMBA-C2460-R10	ATX motherboard supports 14nm LGA1151 Intel® 8th/9th Generation Xeon® E, Core™ i9/i7/i5/i3, Celeron® and Pentium® processor per Intel® C246, DDR4, triple displays, dual GbE LAN, M.2, USB 3.2, SATA 6Gb/s, HD Audio and RoHS
19800-000075-RS	PS/2 KB/MS cable with bracket, 220mm, P=2.0
19800-003100-100-RS	Dual port USB cable with bracket, 30mm, P=2.54
19800-010500-200-RS	USB 3.2 Gen 1 (5Gb/s) cable 457mm with bracket
32102-000100-200-RS	SATA power cable, MOLEX 5264-4P to SATA15P
32205-000702-200-RS	RS-232 cable, 230mm, P=2.54
CF-115XA-R10	High performance LGA115X cooler kit ,1U chassis compatible, 73W
CF-1156C-R20	LGA1155/LGA1156 cooler kit, 1U chassis compatible, 45W
CF-1156D-R30	LGA1155/LGA1156 cooler kit, 1U chassis compatible, 65W
CF-115XE-R10	High-performance LGA1155/1156 cooler kit, 95W
TPM-IN02-R20	20-pin Infineon TPM 2.0 module, software management tool, firmware v5.5

IMBA-Q370

ATX motherboard supports 14nm LGA1151 Intel® 8th/9th Generation Core™ i9/i7/i5/i3, Celeron® and Pentium® processor, DDR4, triple independent displays, dual GbE LAN, M.2, USB 3.2 Gen 2 (10Gb/s), SATA 6Gb/s, HD Audio and RoHS

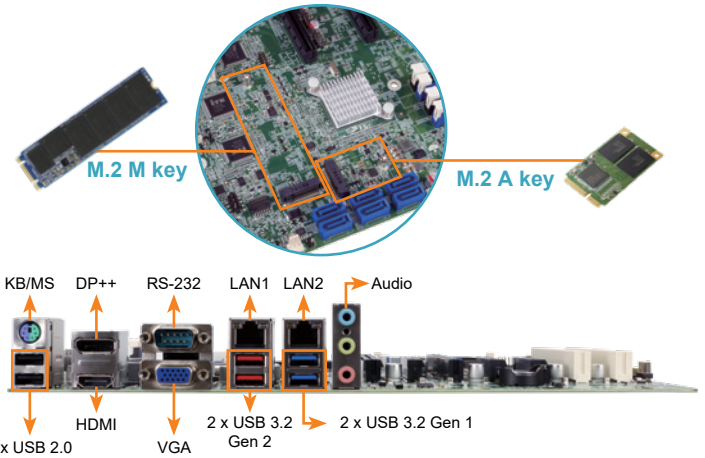
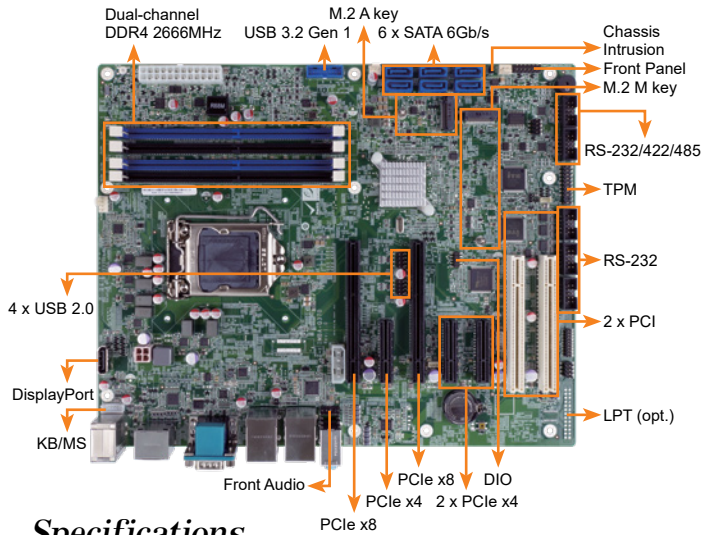

Specifications

- ◆ CPU
LGA1151 socket supports 8th/9th generation Intel® Core™ i9/i7/i5/i3, Pentium® or Celeron® processor
- ◆ Chipset: Intel® Q370
- ◆ BIOS: AMI UEFI BIOS
- ◆ Memory
Four 288-pin 2666/2400 MHz Dual-channel DDR4 SDRAM Unbuffered DIMMS supported up to 64GB
- ◆ Graphics Engine
Intel® HD Graphics Gen9 Engines with Low power 16 execution unit, supports DX11.3/12, OpenGL 4.3/4.4/4.5 and OpenCL 1.2/2.0/2.1
- ◆ Display Output
Triple independent display
1 x VGA (up to 1920 x 1080@60Hz)
1 x DP++ (up to 4096 x 2304@60Hz)
1 x HDMI (up to 4096 x 2304@30Hz)
1 x internal DisplayPort (up to 4096 x 2304@60Hz)
- ◆ Ethernet
LAN1 : Intel® I219LM PCIe controller with AMT 11.0 support
LAN2: Intel® I211AT PCIe controller
- ◆ External I/O Interface
2 x USB 3.2 Gen 2 (10Gb/s) 1 x RS-232
2 x USB 3.2 Gen 1 (5Gb/s) 1 x PS/2 KB/MS
2 x USB 2.0
- ◆ Internal I/O Interface
1 x 180° Displayport 1 x KB/MS (1x6 pin)
2 x RS-232/422/485 (2x5 pin, P=2.54) 3 x RS-232 (2x5 pin, P=2.54)
2 x USB 3.2 Gen 1 (5Gb/s) (2x10 pin, P=2.0) 4 x USB 2.0 (2x4 pin, P=2.54)
6 x SATA 6Gb/s (RAID 0/1/5/10 supported)
- ◆ SMBus: 1 x SMBus (1x4 pin)
- ◆ I²C: 1 x I²C (1x4 pin)
- ◆ Audio
Realtek ALC888S HD Audio codec
3 x Audio Jack (Line-in, Line-out, Mic-in)
1 x Analog audio (2x5 pin)
- ◆ Front Panel
1 x Front Panel (2x7 pin, Power LED, HDD LED, Speaker, Power Button, Reset Button)
- ◆ LAN LED: 2 x LAN LED (1x2 pin)
- ◆ Expansion
2 x PCIe x8 1 x M.2 A key (2230, PCIe x1 & USB 2.0)
3 x PCIe x4 1 x M.2 M Key (2280, PCIe x2 only)
2 x PCI
- ◆ Digital I/O: 1 x 8-bit digital I/O (2x5 pin)
- ◆ TPM: 1 x TPM (2x10 pin)
- ◆ FAN Connector
1 x CPU fan connector (1x4 pin)
2 x System fan connector (1x3 pin)
- ◆ Chassis Open: 1 x Chassis intrusion (1x2 pin)
- ◆ Power supply
ATX/AT power supply
Support AT/ATX mode
ErP/EuP Compliant
- ◆ Watchdog Timer: Software programmable support 1~255 sec. system reset
- ◆ Power Consumption
3.3V@1.65A, 5V@3.4A, 12V@8.58A, 5VSV@3.4A (Intel® Core® i7-8700K up to 4.60 GHz CPU with 32GB 2600MHz DDR4 memory)
- ◆ Operating Temperature: -20°C ~ 60°C
- ◆ Storage Temperature: -30°C ~ 70°C
- ◆ Operating Humidity: 5% ~ 95%, non-condensing
- ◆ Dimensions: 244mm x 305mm
- ◆ Weight: GW:1200g / NW:700g
- ◆ CE/FCC compliant



Features

- LGA1151 Intel® 8th/9th Generation Core™ i9/i7/i5/i3, Celeron® and Pentium® processor
- Dual-channel DDR4 2666MHz
- Support VGA, HDMI & DP++
- Support M.2 A key for WLAN expansion, M key for storage

Packing List

1 x IMBA-Q370 single board computer	2 x SATA cable
1 x I/O shielding	1 x QIG

Dimensions (Unit: mm)

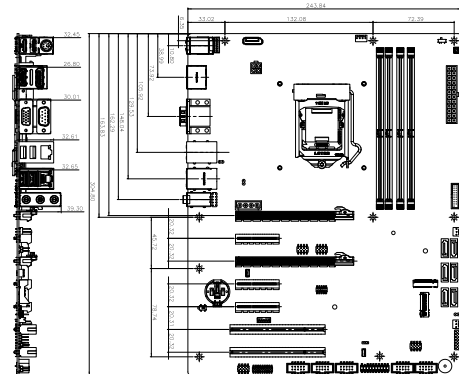

Ordering Information

Part No.	Description
IMBA-Q370-R10	ATX motherboard supports 14nm LGA1151 Intel® 8th/9th Generation Core™ i9/i7/i5/i3, Celeron® and Pentium® processor, DDR4, triple independent displays, dual GbE LAN, M.2, USB 3.2, SATA 6Gb/s, HD Audio and RoHS
19800-000075-RS	PS/2 KB/MS cable with bracket, 220mm, P=2.0
19800-003100-100-RS	Dual port USB cable with bracket, 30mm, P=2.54
19800-010500-200-RS	USB 3.2 Gen 1 (5Gb/s) cable 457mm with bracket
32102-000100-200-RS	SATA power cable, MOLEX 5264-4P to SATA15P
32205-000702-200-RS	RS-232 cable, 230mm, P=2.54
CF-115XA-R10	High performance LGA115X cooler kit, 1U chassis compatible, 73W
CF-1156C-R20	LGA1155/LGA1156 cooler kit, 1U chassis compatible, 45W
CF-1156D-R20	LGA1155/LGA1156 cooler kit, 1U chassis compatible, 65W
CF-115XE-R10	High-performance LGA1155/1156 cooler kit, 95W
TPM-IN02-R20	20-pin Infineon TPM 2.0 module, software management tool, firmware v5.5

IMBA-C2360-i2

ATX motherboard supports 14nm LGA1151 Intel® Xeon® E3 v5 series, Core™ i3, Pentium®, Celeron® processor per Intel® C236, DDR4, triple independent display, HDMI 2.0, dual Intel® PCIe GbE, USB 3.2 Gen 1 (5Gb/s), SATA 6Gb/s, HD Audio, IPMI 2.0 and RoHS

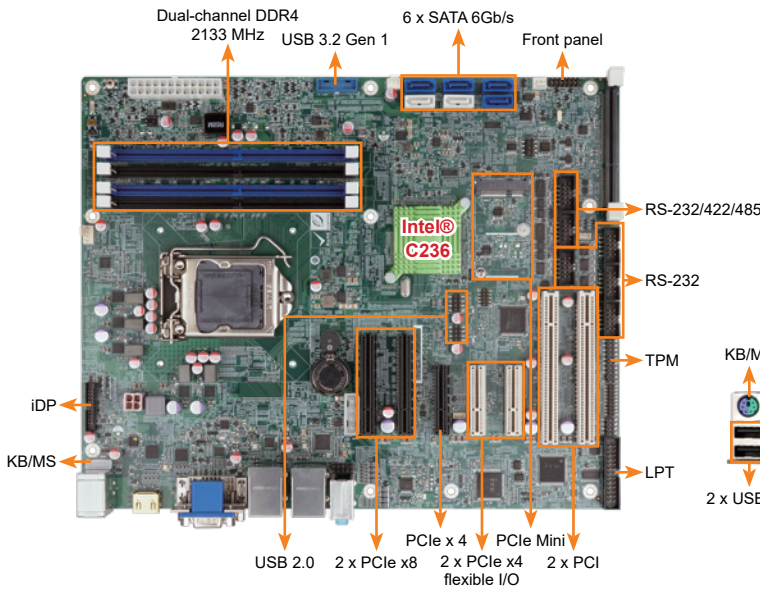

Dual BIOS (for flexible I/O only)

Easy for customer to switch different ME firmware to achieve I/O flexibility

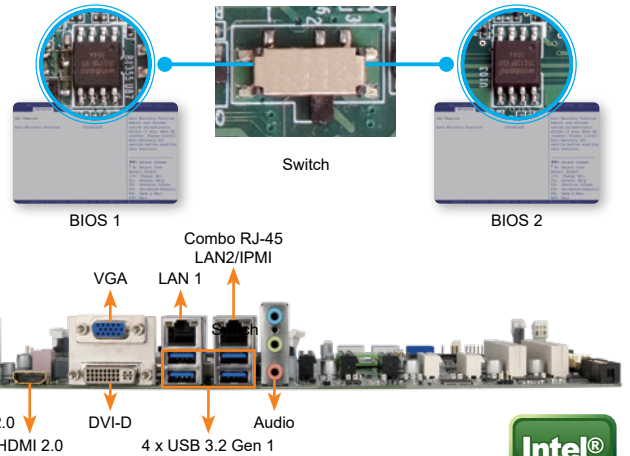

Specifications

- ◆ CPU
LGA 1151 socket supports Intel® Xeon® E3 v5/v6, 6th/7th generation Core™ i3, Pentium® or Celeron® processor
- ◆ Chipset
Intel® C236
- ◆ Memory
Four 288-pin 2133 MHz dual-channel DDR4 SDRAM ECC and non-ECC unbuffered DIMMs support up to 64 GB
- ◆ BIOS
UEFI BIOS
- ◆ Graphics Engine
Intel® HD Graphics Gen 9 engine with 16 low-power execution units, supports DX11/12, OpenGL 4.3/4.4 and OpenCL2.x, ES 2.0
- ◆ Display Output
Triple independent display
1 x VGA (up to 1920x1200@60Hz)
1 x DVI-D (up to 1920x1200@60Hz)
1 x HDMI 2.0 (up to 4096x2160@60Hz)
1 x iDP interface for HDMI, LVDS, VGA, DVI, DP (up to 3840x2160@60Hz)
- ◆ Ethernet
LAN1: Intel® I219LM with Intel® AMT 11.0 support
LAN2: Intel® I210AT PCIe controller with NCSI support
- ◆ External I/O Interface
2 x USB 2.0
4 x USB 3.2 Gen 1 (5Gb/s)
1 x KB/MS
- ◆ Internal I/O Interface
1 x KB/MS (1x6 pin) 4 x RS-232 (2x5 pin, P=2.54)
1 x LPT (2x13 pin, P=2.54) 4 x USB 2.0 (2x4 pin, P=2.0)
2 x USB 3.2 Gen 1 (5Gb/s) (2x10 pin, P=2.0) 6 x SATA 6Gb/s
2 x RS-232/422/485 (2x5 pin, P=2.54)
- ◆ SMBus: 1 x SMBus (1x4 pin)
- ◆ I²C: 1 x I²C (1x4 pin)
- ◆ TPM: 1 x TPM (2x10 pin)
- ◆ Audio
Realtek ALC888S HD Audio codec supports 7.1-channel
3 x Audio jacks (line-out, line-in, mic-in) on rear IO
1 x Front audio (2x5 pin)
- ◆ Front Panel
1 x Front panel (2x7 pin, power LED, HDD LED, speaker, power button, reset button)
- ◆ LAN LED: 2 x LAN LED (1x2 pin)
- ◆ Expansion
1 x Full-size PCIe Mini card slot (support mSATA) 2 x PCIe x8 slot (Gen3)
2 x PCI slot 3 x PCIe x4 slot (Gen3)
- ◆ Watchdog Timer: Software programmable supports 1~255 sec. system reset
- ◆ Digital I/O: 8-bit digital I/O (2x5 pin)
- ◆ Fan Connector
1 x CPU smart fan (1x4 pin)
2 x System smart fan (1x3 pin)
- ◆ Power Supply: ATX/AT power supply
- ◆ Power Consumption
3.3V@1.51A, 5V@3.31A, 12V@9.02A, 5VSB@3.7A (Intel® Xeon® E3-1275 v5 3.60 GHz CPU with 32 GB (four 8GB) 2133 MHz DDR4 memory)
- ◆ Operating Temperature: -20°C ~ 60°C
- ◆ Storage Temperature: -30°C ~ 70°C
- ◆ Operating Humidity: 5% ~ 95%, non-condensing
- ◆ Dimensions: 244mm x 305mm
- ◆ Weight: GW: 1200g / NW: 700g
- ◆ CE/FCC compliant



Features

- LGA 1151 Intel® Xeon® E3 v5/v6, 6th/7th generation Core™ i3, Pentium® or Celeron® processor supported
- Dual-channel DDR4 2133 MHz
- Intel® PCIe GbE with Intel® AMT11.0 support
- Support independent triple display with HDMI, DVI and VGA
- Support PCI Express generation 3.0 at 8GT/s I/O bandwidth
- USB 3.2 Gen 1 (5Gb/s) and SATA 6Gb/s

Packing List

1 x IMBA-C2360-i2 single board computer	2 x SATA cable
1 x I/O shielding	1 x QIG

Ordering Information

Part No.	Description
IMBA-C2360-i2-R10	ATX motherboard supports 14nm LGA1151 Intel® Xeon® E3 v5 series, Core™ i3, Pentium®, Celeron® processor per Intel® C236, DDR4, triple independent display VGA/DVI-D/HDMI 2.0, dual Intel® PCIe GbE, USB 3.2 Gen 1 (5Gb/s), SATA 6Gb/s, HD Audio, IPMI 2.0 and RoHS
19800-000075-RS	PS/2 KB/MS cable with bracket, 220mm, P=2.0
19800-000049-RS	LPT flat cable, 240mm, P=2.54
19800-003100-100-RS	Dual port USB cable with bracket, 30mm, P=2.54
19800-010500-200-RS	USB 3.2 Gen 1 (5Gb/s) cable with bracket, 457mm
32102-000100-200-RS	SATA power cable, MOLEX 5264-4P to SATA15P
CF-1156C-R20	LGA1155/LGA1156 cooler kit, 1U chassis compatible, 45W
CF-1156D-R30	LGA1155/LGA1156 cooler kit, 1U chassis compatible, 65W
CF-115XE-R10	High performance LGA1155/LGA1156 cooler kit, 95W
CF-115XA-R10	High-performance LGA1155/1156 cooler kit, 1U chassis compatible 73W
DP-DP-R10	DisplayPort to DisplayPort converter board (for IEI iDP connector)
DP-DVI-R10	DisplayPort to DVI-D converter board (for IEI iDP connector)
DP-HDMI-R10	DisplayPort to HDMI converter board (for IEI iDP connector)
DP-LVDS-R10	DisplayPort to 24-bit dual-channel LVDS converter board (for IEI iDP connector)
DP-VGA-R10	DisplayPort to VGA converter board (for IEI iDP connector)
TPM-IN02-R20	20-pin Infineon TPM 2.0 module, software management tool, firmware v5.5

IMBA-Q170-i2

ATX motherboard supports 14nm LGA1151 Intel® CPU, Intel® Q170, DDR4, triple independent display VGA/ DVI-D/ HDMI 2.0, dual Intel® PCIe GbE, USB 3.2 Gen 1 (5Gb/s), SATA 6Gb/s, HD Audio, IPMI 2.0 and RoHS

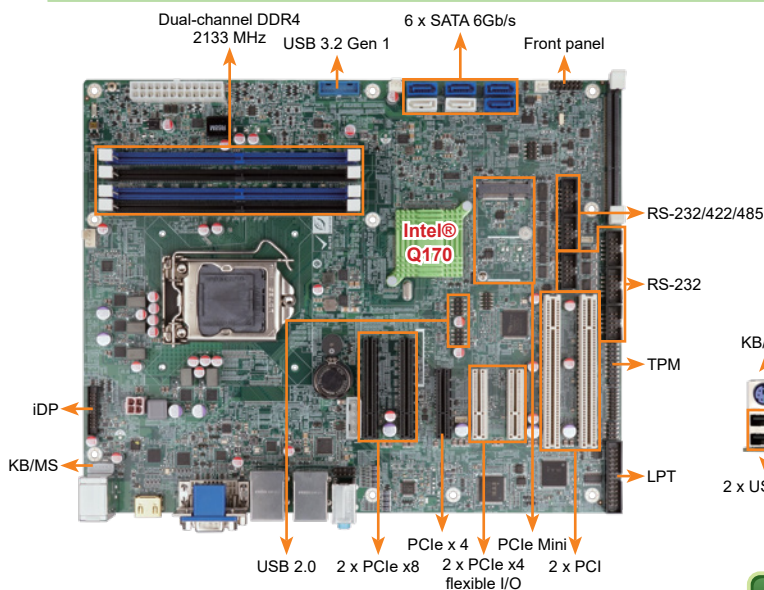

Flexible I/O support

IEI USB 3.2 Gen 1 (5Gb/s) & mSATA/PCIe Mini expansion card

The expansion card can provide more choices to meet users demand

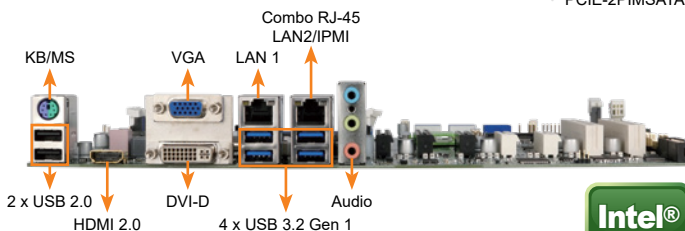
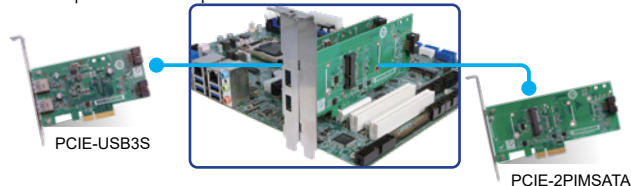

Specifications

- ◆ CPU
LGA 1151 socket supports Intel® 6th/7th generation Core™ i7/i5/i3, Pentium® or Celeron® processor
- ◆ Chipset
Intel® Q170
- ◆ Memory
Four 288-pin 2133 MHz dual-channel DDR4 SDRAM unbuffered DIMMs support up to 64 GB
- ◆ BIOS: UEFI BIOS
- ◆ Graphics Engine
Intel® HD Graphics Gen 9 engine with 16 low-power execution units, supports DX11/12, OpenGL 4.3/4.4 and OpenCL2.x, ES 2.0
- ◆ Display Output
Triple independent display
1 x VGA (up to 1920x1200@60 Hz)
1 x DVI-D (up to 1920x1200@60Hz)
1 x HDMI 2.0 (up to 4096x2160@60Hz)
1 x iDP interface for HDMI, LVDS, VGA, DVI, DP (up to 3840x2160@60Hz)
- ◆ Ethernet
LAN1: Intel® I219LM with Intel® AMT 11.0 support
LAN2: Intel® I210AT PCIe controller with NCSI support
- ◆ External I/O Interface
2 x USB 2.0
4 x USB 3.2 Gen 1 (5Gb/s)
1 x KB/MS
- ◆ Internal I/O Interface
1 x KB/MS (1x6 pin) 4 x RS-232 (2x5 pin, P=2.54)
1 x LPT (2x13 pin, P=2.54) 4 x USB 2.0 (2x4 pin, P=2.0)
2 x USB 3.2 Gen 1 (5Gb/s) (2x10 pin, P=2.0) 6 x SATA 6Gb/s (RAID 0/1/5/10 supported)
2 x RS-232/422/485 (2x5 pin, P=2.54)
- ◆ SMBus: 1 x SMBus (1x4 pin)
- ◆ PC: 1 x PC (1x4 pin)
- ◆ TPM: 1 x TPM (2x10 pin)
- ◆ Audio
Realtek ALC888S HD Audio codec supports 7.1-channel
3 x Audio jacks (line-out, line-in, mic-in) on rear IO
1 x Front audio (2x5 pin)
- ◆ Front Panel
1 x Front panel (2x7 pin, power LED, HDD LED, speaker, power button, reset button)
- ◆ LAN LED: 2 x LAN LED (1x2 pin)
- ◆ Expansion
1 x Full-size PCIe Mini card slot (support mSATA)
2 x PCI slot
2 x PCIe x 8 slot (Gen3)
3 x PCIe x 4 slot (Gen3)
- ◆ Watchdog Timer
Software programmable supports 1~255 sec. system reset
- ◆ Digital I/O: 8-bit digital I/O (2x5 pin)
- ◆ Fan Connector
1 x CPU smart fan (1x4 pin)
2 x System smart fan (1x3 pin)
- ◆ Chassis Open: 1 x Chassis intrusion (1x2 pin)
- ◆ Power Supply: ATX/AT power supply
- ◆ Power Consumption
3.3V@1.65A, 5V@3.4A, 12V@8.58A, 5VSB@0.22A
(Intel® Core™ i7-6700K 4.0GHz CPU with 32 GB (four 4 GB) 2133 MHz DDR4 memory)
- ◆ Operating Temperature: -20°C ~ 60°C
- ◆ Storage Temperature: -30°C ~ 70°C
- ◆ Operating Humidity: 5% ~ 95%, non-condensing
- ◆ Dimensions: 244mm x 305mm
- ◆ Weight: GW: 1200g / NW: 700g
- ◆ CE/FCC compliant



Features

- LGA 1151 Intel® 6th/7th generation Core™ i7/i5/i3, Pentium® or Celeron® processor supported
- Dual-channel DDR4 2133 MHz
- Support triple display with HDMI, DVI and VGA
- Support USB 3.2 Gen 1 (5Gb/s), SATA 6Gb/s and PCI Express Gen3

Packing List

1 x IMBA-Q170-i2 single board computer	2 x SATA cable
1 x I/O shielding	1 x QIG

Ordering Information

Part No.	Description
IMBA-Q170-i2-R10	ATX motherboard supports 14nm LGA1151 Intel® CPU, Intel® Q170, DDR4, triple independent display VGA/ DVI-D/ HDMI 2.0, dual Intel® PCIe GbE, USB 3.2 Gen 1 (5Gb/s), SATA 6Gb/s, HD Audio, IPMI 2.0 and RoHS
IMBA-Q170-ECO-R10	ATX motherboard supports 14nm LGA1151 Intel® CPU, Intel® Q170, DDR4, triple independent display VGA/ DVI-D/ HDMI 2.0, dual Intel® PCIe GbE, USB 3.2 Gen 1 (5Gb/s), SATA 6Gb/s, HD Audio, ECO packing and RoHS (10 pcs/pack)
19800-000049-RS	LPT flat cable, 240mm, P=2.54
19800-000075-RS	PS/2 KB/MS cable with bracket, 220mm, P=2.0
19800-003100-100-RS	Dual port USB cable with bracket, 30mm, P=2.54
19800-010500-200-RS	USB 3.2 Gen 1 (5Gb/s) cable 457mm with bracket
32102-000100-200-RS	SATA power cable, MOLEX 5264-4P to SATA15P
32205-000702-200-RS	RS-232 cable, 230mm, P=2.54
CF-1156C-R20	LGA1155/LGA1156 cooler kit, 1U chassis compatible, 45W
CF-1156D-R30	LGA1155/LGA1156 cooler kit, 1U chassis compatible, 65W
CF-115XE-R10	High-performance LGA1155/1156 cooler kit, 95W
CF-115XA-R10	High-performance LGA1155/1156 cooler kit, 1U chassis compatible 73W
DP-DP-R10	DisplayPort to DisplayPort converter board (for IEI iDP connector)
DP-DVI-R10	DisplayPort to DVI-D converter board (for IEI iDP connector)
DP-HDMI-R10	DisplayPort to HDMI converter board (for IEI iDP connector)
DP-LVDS-R10	DisplayPort to 24-bit dual-channel LVDS converter board (for IEI iDP connector)
DP-VGA-R10	DisplayPort to VGA converter board (for IEI iDP connector)
TPM-IN02-R20	20-pin Infineon TPM 2.0 module, software management tool, firmware v5.5

IMBA-H112

ATX Motherboard supports 14nm LGA1151 6th/7th Generation Intel® Core i7/i5/i3, Celeron® and Pentium® processor, DDR4, Dual Independent Displays VGA and HDMI, Dual Intel GbE LAN, USB 3.2, SATA 6Gb/s, HD Audio and RoHS

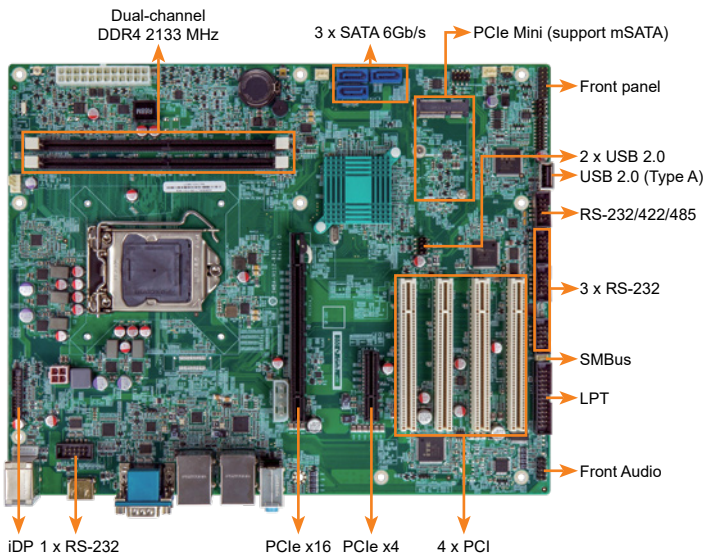

PCIe and PCI Slots for Multiple Expansion Support

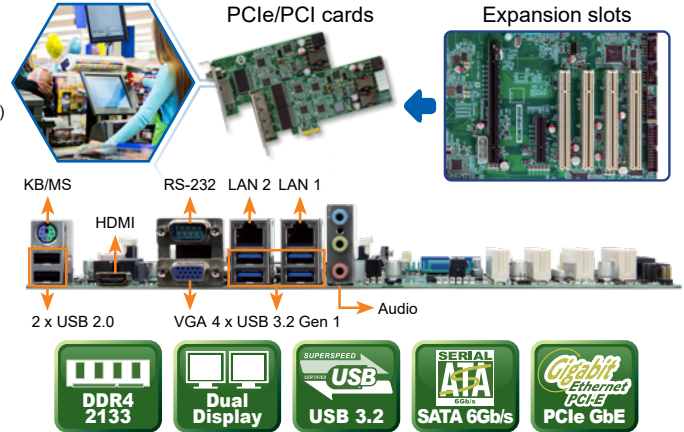

Specifications

- ◆ CPU
LGA 1151 socket supports Intel® 6th/7th generation Core™ i7/i5/i3, Pentium® or Celeron® processor
- ◆ System Chipset
Intel® H110
- ◆ Memory
Two 288-pin 2133 MHz dual-channel DDR4 SDRAM unbuffered DIMMs support up to 64 GB
- ◆ BIOS
AMI UEFI BIOS
- ◆ Graphic Engine
Intel® HD Graphics Gen 9 Engines with Low power 16 execution unit, supports DX2015, OpenGL 5.X and OpenCL2.x, ES 2.0
- ◆ Display Output
Dual independent display
1 x VGA (up to 1920 x 1080@60Hz)
1 x HDMI 1.4 (up to 4096x2160@24Hz)
1 x iDP interface for HDMI, LVDS, VGA, DVI, DP (up to 3840x2160@60Hz)
- ◆ Ethernet
LAN1: Intel® I219V PHY
LAN2: Intel® I211 PCIe controller
- ◆ External I/O Interface
4 x USB 3.2
2 x USB 2.0
1 x RS-232
1 x KB/MS
- ◆ Internal I/O Interface
1 x KB/MS (1x6 pin)
1 x LPT (2x13 pin, P=2.54)
1 x USB 2.0 (type A)
2 x USB 2.0 (2x4 pin, P=2.54)
1 x RS-232/422/485 (2x5 pin, P=2.54)
3 x SATA 6Gb/s (support Hot plug)
4 x RS-232 (2x5 pin, P=2.54)
- ◆ SMBus: 1 x SMBus (1x4 pin)
- ◆ I²C: 1 x I²C (1x4 pin)
- ◆ Audio
Realtek ALC888S HD Audio codec supports 7.1-channel (2 Audio Jack colay 3 Jack) (Line-out, Mic)
- ◆ Front Audio
2x5 pin pin header
- ◆ Front Panel
1 x Front Panel (2x7 pin, Power LED, HDD LED, Speaker, Power Button, Reset Button)
- ◆ LAN LED
2 x LAN LED (1x2 pin)
- ◆ Expansion
1 x Full-size PCIe Mini card slot (support mSATA)
1 x PCIe x16 slot (Gen3)
1 x PCIe x4
4 x PCI slot
- ◆ Watchdog Timer
Software Programmable support 1~255 sec. system reset
- ◆ Fan Connector
1 x CPU smart fan (1x4 pin) 2 x System smart fan (1x3 pin)
- ◆ Power Supply: ATX/AT Power Supply
- ◆ Power Consumption
3.3V@1.53A, 5V@2.95A, 12V@8.38A, 5VSB@3.2A (4.0 GHz Intel® Core™ i7-6700K CPU with two 8 GB 2133 MHz DDR4 memory)
- ◆ Operating Temperature: -20°C~60°C
- ◆ Storage Temperature: -20°C~70°C
- ◆ Operating Humidity: 5% ~ 95%, non-condensing
- ◆ Weight: 1200g / NW: 700g
- ◆ CE/FCC compliant

Features

- LGA 1151 Intel® 6th/7th generation Core™ i7/i5/i3, Pentium® or Celeron® processor supported
- Dual-channel DDR4 2133MHz
- Support dual displays with VGA/HDMI/iDP
- Support USB 3.2 Gen 1 (5Gb/s) and SATA 6Gb/s

Dimensions (Unit: mm)

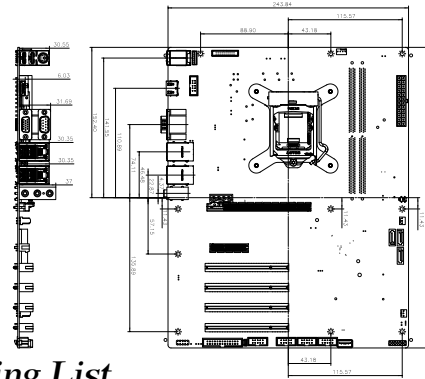

Packing List

1 x IMBA-H112 single board computer	2 x SATA cable
1 x I/O shielding	1 x QIG

Ordering Information

Part No.	Description
IMBA-H112-R10	ATX Motherboard supports 14nm LGA1151 6th/7th Generation Intel® Core™ i7/i5/i3, Celeron® and Pentium® processor, DDR4, Dual Independent Displays VGA and HDMI, Dual Intel® GbE LAN, USB 3.2, SATA 6Gb/s, HD Audio and RoHS
IMBA-H112-ECO-R10	ATX Motherboard supports 14nm LGA1151 6th/7th Generation Intel® Core™ i7/i5/i3, Celeron® and Pentium® processor, DDR4, Dual Independent Displays VGA and HDMI, Dual Intel® GbE LAN, USB 3.2, SATA 6Gb/s, HD Audio, ECO packing and RoHS (10 pcs/pack)
19800-000049-RS	LPT flat cable, 240mm, P=2.54
19800-000075-RS	PS/2 KB/MS cable with bracket, 220mm, P=2.0
19800-020100-100-RS	RS-232 cable, 230mm, P=2.54
32102-000100-200-RS	SATA power cable, MOLEX 5264-4P to SATA15P
32801-000703-500-RS	SATA cable, 2, 500mm, 26AWG, 30V, SATA 7P female 180°+LOCK, one pcs pkg W/ label, 32000-062800-RS substitute, Wins Precision, RoHS
CF-1156C-R20	LGA1155/LGA1156 cooler kit, 1U chassis compatible, 45W
CF-1156D-R30	LGA1155/LGA1156 cooler kit, 1U chassis compatible, 65W
CF-115XE-R10	High performance LGA1155/LGA1156 cooler kit, 95W
CF-115XA-R10	High-performance LGA1155/L1156 cooler kit, 1U chassis compatible 73W
DP-DP-R10	DisplayPort to DisplayPort converter board (for IEI iDP connector)
DP-DVI-R10	DisplayPort to DVI-D converter board (for IEI iDP connector)
DP-HDMI-R10	DisplayPort to HDMI converter board (for IEI iDP connector)
DP-LVDS-R10	DisplayPort to 24-bit dual-channel LVDS converter board (for IEI iDP connector)
DP-VGA-R10	DisplayPort to VGA converter board (for IEI iDP connector)

IMBA-H110

ATX motherboard supports 14nm LGA1151 6th/7th Generation Intel® Core™ i7/i5/i3, Celeron® and Pentium® processor, DDR4, dual independent displays DVI-I/HDMI/iDP, dual Intel® GbE LAN, USB 3.2 Gen 1 (5Gb/s), SATA 6Gb/s, HD Audio and RoHS

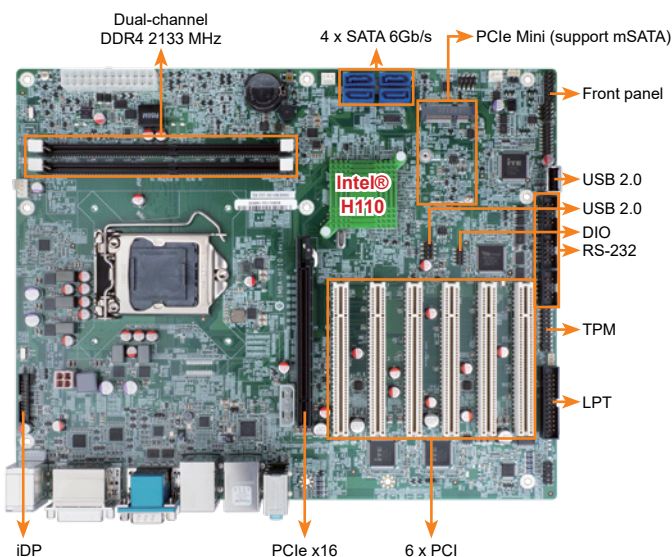

Specifications

- ◆ CPU
LGA 1151 socket supports Intel® 6th/7th generation Core™ i7/i5/i3, Pentium® or Celeron® processor
- ◆ Chipset
Intel® H110
- ◆ Memory
Two 288-pin 2133 MHz dual-channel DDR4 SDRAM unbuffered DIMMs support up to 64 GB
- ◆ BIOS
UEFI BIOS
- ◆ Graphics Engine
Intel® HD Graphics Gen 9 engine with 16 low-power execution units supports DX2015, OpenGL 5.X and OpenCL2.x, ES 2.0
- ◆ Display Output
Dual independent display
1 x DVI-I (up to 1920x1200@60Hz)
1 x HDMI 1.4 (up to 4096x2160@24Hz)
1 x iDP interface for HDMI, LVDS, VGA, DVI, DP (up to 3840x2160@60Hz)
- ◆ Ethernet
LAN1: Intel® I219LM PCIe controller
LAN2: Intel® I211 PCIe controller
- ◆ External I/O Interface
4 x USB 3.2 Gen 1 (5Gb/s)
2 x USB 2.0
2 x RS-232
1 x KB/MS
- ◆ Internal I/O Interface
1 x KB/MS (1x6 pin) 2 x RS-232 (2x5 pin, P=2.54)
1 x LPT (2x13 pin, P=2.54) 2 x USB 2.0 (2x4 pin, P=2.54)
1 x RS-232/422/485 (2x5 pin, P=2.54) 4 x SATA 6Gb/s
1 x USB 2.0 (180° Type-A)
- ◆ SMBus
1 x SMBus (1x4 pin)
- ◆ I²C
1 x I²C (1x4 pin)
- ◆ TPM
1 x TPM (2x10 pin)
- ◆ Audio
Realtek ALC888S HD audio codec supports 7.1-channel
3 x Audio jacks (line-out, line-in, mic-in) on rear IO
1 x Front audio (2x5 pin)
- ◆ Front Panel
1 x Front panel (2x7 pin, power LED, HDD LED, speaker, power button, reset button)
- ◆ LAN LED: 2 x LAN LED (1x2 pin)
- ◆ Expansion
1 x Full-size PCIe Mini card slot (support mSATA)
1 x PCIe x16 slot (Gen3)
6 x PCI slot
- ◆ Watchdog Timer: Software programmable supports 1~255 sec. system reset
- ◆ Digital I/O: 8-bit digital I/O (2x5 pin)
- ◆ Fan Connector
1 x CPU smart fan (1x4 pin) 2 x System fan (1x3 pin)
- ◆ Power Supply: ATX/AT power supply
- ◆ Power Consumption
3.3V@1.53A, 5V@2.95A, 12V@8.38A, 5VSB@3.2A
(Intel® Core™ i7 6700K 4.0GHz CPU with 16GB (two 8GB) 2133 MHz DDR4 memory)
- ◆ Operating Temperature: -20°C ~ 60°C
- ◆ Storage Temperature: -30°C ~ 70°C
- ◆ Operating Humidity: 5% ~ 95%, non-condensing
- ◆ Dimensions: 244mm x 305mm
- ◆ Weight: GW: 1200g / NW: 700g
- ◆ CE/FCC compliant

Multiple PCI Expansion Support

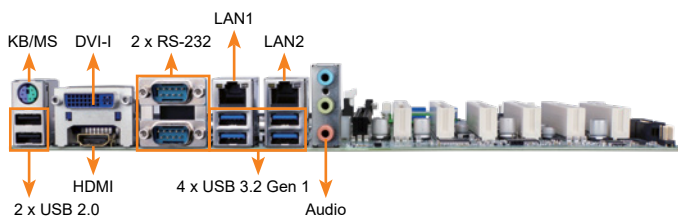
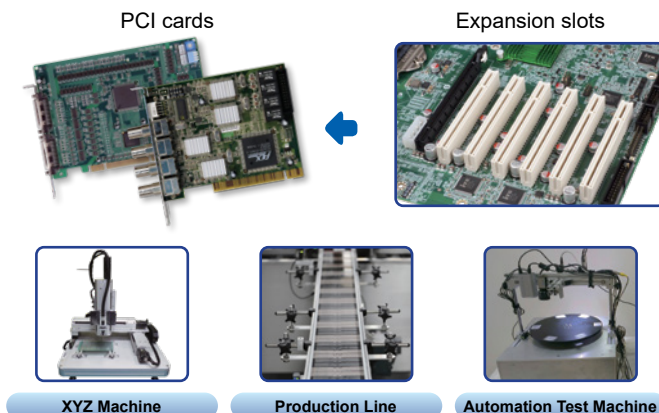

Features

- LGA 1151 Intel® 6th/7th generation Core™ i7/i5/i3, Pentium® or Celeron® processor supported
- Dual-channel DDR4 2133 MHz
- Support dual displays with DVI-I/HDMI/iDP
- Support USB 3.2 Gen 1 (5Gb/s) and SATA 6Gb/s

Packing List

1 x IMBA-H110 single board computer	2 x SATA cable
1 x I/O shielding	1 x QIG

Ordering Information

Part No.	Description
IMBA-H110-R10	ATX motherboard supports 14nm LGA1151 6th Generation Intel® Core™ i7/i5/i3, Celeron® and Pentium® processor, DDR4, dual independent displays DVI-I/HDMI/iDP, dual Intel® GbE LAN, SATA 6Gb/s, USB 3.2 Gen 1 (5Gb/s), HD Audio and RoHS
IMBA-H110-ECO-R10	ATX Motherboard supports LGA1151 6th Generation Intel® Core i7/i5/i3, Celeron® Pentium® processor, DDR4, Dual Independent Displays DVI-I/HDMI/iDP, Dual Intel® GbE LAN, USB 3.2, SATA 6Gb/s, HD Audio, ECO Packing, RoHS (10 pcs/pack)
19800-000049-RS	LPT flat cable, 240mm, P=2.54
19800-000075-RS	PS/2 KB/MS cable with bracket, 220mm, P=2.0
19800-020100-100-RS	RS-232 cable, 230mm, P=2.54
32102-000100-200-RS	SATA power cable, MOLEX 5264-4P to SATA15P
CF-1156C-R20	LGA1155/LGA1156 cooler kit, 1U chassis compatible, 45W
CF-1156D-R30	LGA1155/LGA1156 cooler kit, 1U chassis compatible, 65W
CF-115XE-R10	High performance LGA1155/LGA1156 cooler kit, 95W
CF-115XA-R10	High-performance LGA1155/1156 cooler kit, 1U chassis compatible 73W
DP-DP-R10	DisplayPort to DisplayPort converter board (for IEI iDP connector)
DP-DVI-R10	DisplayPort to DVI-D converter board (for IEI iDP connector)
DP-HDMI-R10	DisplayPort to HDMI converter board (for IEI iDP connector)
DP-LVDS-R10	DisplayPort to 24-bit dual-channel LVDS converter board (for IEI iDP connector)
DP-VGA-R10	DisplayPort to VGA converter board (for IEI iDP connector)
TPM-IN02-R20	20-pin Infineon TPM 2.0 module, software management tool, firmware v5.5

IMBA-H810

ATX motherboard supports 22nm LGA 1150 4th generation Intel® Core™ i7/i5/i3, Pentium® and Celeron® CPU with Intel® H81, DDR3, VGA/DVI-D/iDP, dual Intel® PCIe GbE, USB 3.2 Gen 1 (5Gb/s), SATA 6Gb/s, HD Audio and RoHS

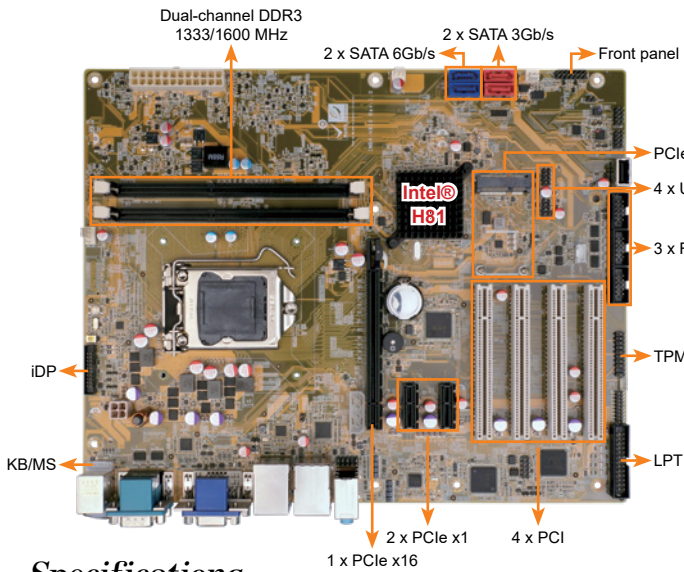

PCIe Mini Add-on Value

IEI USB 3.2 Gen 1 (5Gb/s) Expanded Solution

The MPCIE-USB3 board can be installed to add two additional SuperSpeed USB 3.2 Gen 1 (5Gb/s) ports for the motherboard via the PCIe Mini slot.

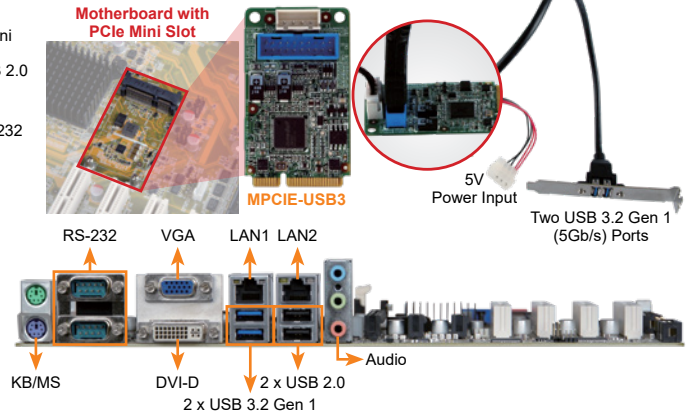

Specifications

- ◆ CPU: LGA1150 Intel® Core™ i7/i5/i3, Pentium® and Celeron® processor supported
- ◆ Chipset: Intel® H81
- ◆ Memory: Two 240-pin 1600/1333 MHz dual-channel DDR3 SDRAM unbuffered DIMMs support up to 16GB
- ◆ BIOS: UEFI BIOS
- ◆ Graphics Engine: Intel® HD Graphics Gen 7.5 supports DX11.1 and OpenCL 1.2, OpenGL 3.2 Full MPEG2, VC1, AVC Decode
- ◆ Display Output: Dual independent display
 - 1 x VGA (up to 1920x1200@60 Hz)
 - 1 x DVI-D (up to 2560x1600@60 Hz)
 - 1 x iDP interface for HDMI, LVDS, VGA, DVI, DP (up to 3840x2160@60 Hz)
- ◆ Ethernet: LAN1: Intel® I217-LM with Intel® AMT9.0 support; LAN2: Intel® I211-AT PCIe Controller
- ◆ External I/O Interface: 1 x KB/MS, 2 x RS-232, 2 x USB 2.0, 2 x USB 3.2 Gen 1 (5Gb/s)
- ◆ Internal I/O Interface: 1 x KB/MS (1x6 pin), 1 x LPT (2x13 pin), 1 x mSATA (share with SATA4), 1 x RS-422/485 (1x4 pin, P=2.0), 2 x SATA 6Gb/s (SATA1, SATA2) (AHCI supported, no RAID) (Blue)
 - 1 x USB 2.0 (180° Type-A)
 - 2 x SATA 3Gb/s (SATA3, SATA4) (Red)
 - 3 x RS-232 (2x5 pin, P=2.54)
 - 4 x USB 2.0 (2x4 pin, P=2.54)
- ◆ Audio: Realtek ALC888S HD Audio codec supports 7.1-channel
 - 3 x Audio jacks (line-out, line-in, mic-in) on rear IO
 - 1 x Front audio (2x5 pin)
- ◆ Front Panel: 1 x Front panel (2x7 pin, power LED, HDD LED, speaker, power button, reset button)
- ◆ LAN LED: 2 x LAN LED (1x2 pin)
- ◆ TPM: 1 x TPM (2x10 pin)
- ◆ SMBus: 1 x SMBus (1x4 pin)
- ◆ I²C: 1 x I²C (1x4 pin)
- ◆ Infrared Interface: 1 x Infrared Interface (1x5 pin)
- ◆ Expansion: 1 x Full-size PCIe Mini card slot (support mSATA), 2 x PCIe x1, 1 x PCIe x16, 4 x PCI
- ◆ Watchdog Timer: Software programmable supports 1~255 sec. system reset
- ◆ Digital I/O: 8-bit digital I/O (2x5 pin)
- ◆ Fan Connector: 1 x CPU smart fan (1x4 pin), 1 x System fan (1x3 pin)
- ◆ Chassis Intrusion Detection: 1 x Chassis intrusion connector (1x2 pin)
- ◆ Power Supply: ATX power supply, ATX/AT mode support
- ◆ Power Consumption: 3.3V@0.83A, 5V@2.2A, 12V@3.88A, 5VSB@0.3A (Intel® Core™ i7-4770K 3.90GHz CPU with 8 GB (two 4 GB) 1333 MHz DDR3 memory)
- ◆ Operating Temperature: -20°C ~ 60°C
- ◆ Storage Temperature: -30°C ~ 70°C
- ◆ Operating Humidity: 5% ~ 95%, non-condensing
- ◆ Dimensions: 244 mm x 305 mm
- ◆ Weight: GW: 1200g / NW: 700g
- ◆ CE/FCC compliant



Features

- 4th generation LGA1150 Intel® Core™ i7/i5/i3, Pentium® or Celeron® processor supported
- Dual-channel DDR3 1333/1600 MHz support up to 16 GB
- Intel® HD Graphics technology integrates high-performance graphics and media processing
- USB 3.2 Gen 1 (5Gb/s), and SATA supported
- TPM V1.2 hardware security function supported by TPM module

Packing List

1 x IMBA-H810 single board computer	2 x SATA cable
1 x I/O shielding	1 x QIG

Ordering Information

Part No.	Description
IMBA-H810-R10	ATX motherboard supports 22nm LGA 1150 4th generation Intel® Core™ i7/i5/i3, Pentium® and Celeron® CPU with Intel® H81, DDR3, VGA/DVI-D/iDP, dual Intel® PCIe GbE, SATA 6Gb/s, USB 3.2 Gen 1 (5Gb/s), HD Audio and RoHS
IMBA-H810-ECO-R10	ATX motherboard supports 22nm LGA 1150 4th generation Intel® Core™ i7/i5/i3, Pentium® and Celeron® CPU with Intel® H81, DDR3, VGA/DVI-D/iDP, dual Intel® PCIe GbE, USB 3.2 Gen 1 (5Gb/s), SATA 6Gb/s, HD Audio, ECO packing, RoHS (10 pce/ pack)
19800-000049-RS	LPT flat cable, 240mm, P=2.54
19800-000075-RS	PS/2 KB/MS cable with bracket, 220mm, P=2.0
19800-010500-200-RS	USB 3.2 Gen 1 (5Gb/s) cable with bracket, 450mm
32102-000100-200-RS	SATA power cable, MOLEX 5264-4P to SATA15P
32205-001203-100-RS	RS-232 cable with bracket, Dual 10-pin to dual DB-9, 230mm, P=2.54
32205-003800-200-RS	RS-422/485 cable, 200mm, P=2.0
CF-115XA-R10	High performance LGA1155/LGA1156 cooler kit, 1U chassis compatible, 73W
CF-115XE-R10	High performance LGA1155/LGA1156 cooler kit, 95W
DP-DP-R10	DisplayPort to DisplayPort converter board (for IEI iDP connector)
DP-DVI-R10	DisplayPort to DVI-D converter board (for IEI iDP connector)
DP-HDMI-R10	DisplayPort to HDMI converter board (for IEI iDP connector)
DP-LVDS-R10	DisplayPort to 24-bit dual-channel LVDS converter board (for IEI iDP connector)
DP-VGA-R10	DisplayPort to VGA converter board (for IEI iDP connector)
TPM-IN01-R20	20-pin Infineon TPM module, software management tool, firmware v3.17

IMBA-C2260-i2-R11

ATX motherboard supports 22nm LGA1150 Intel® Xeon E3, Core™ i3, Pentium® and Celeron®, DDR3, VGA, dual Intel® PCIe GbE, USB 3.2 Gen 1 (5Gb/s), SATA 6Gb/s and RoHS

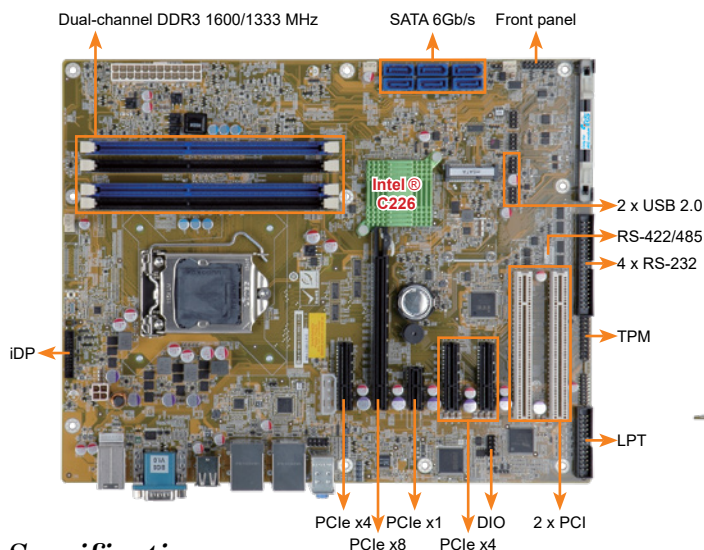

Fully Jumper-less Support

NO jumper pin header

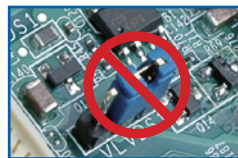

Jumper setting via BIOS menu

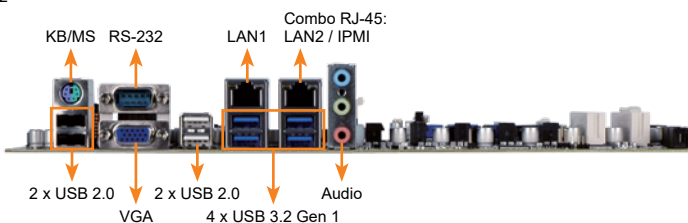

Specifications

- ◆ CPU
LGA1150 Intel® Xeon® E3, Core™ i3, Pentium® or Celeron® processor supported
- ◆ Chipset
Intel® C226
- ◆ Memory
Four 240-pin 1600/1333 MHz dual-channel DDR3 & DDR3L SDRAM ECC and non-ECC unbuffered DIMMs support up to 32 GB
- ◆ BIOS
UEFI BIOS
- ◆ Ethernet
LAN1: Intel® I217LM with Intel® AMT 9.0 support
LAN2: Intel® I210-AT PCIe controller with NCSI support
- ◆ Graphics Engine
Intel® HD Graphics Gen 7.5 supports DX11.1 and OpenCL 1.2, OpenGL 3.2
Full MPEG2, VC1, AVC Decode
- ◆ Display Output
Triple independent display
1 x VGA (up to 1920x1200@60 Hz)
1 x iDP interface for HDMI, LVDS, VGA, DVI, DP (up to 3840x2160@60 Hz)
- ◆ Audio
Realtek ALC888S HD Audio codec supports 7.1-channel
3 x Audio jacks (line-out, line-in, mic-in) on rear IO
1 x Front audio (2x5 pin)
- ◆ External I/O Interface
1 x KB/MS 4 x USB 2.0
1 x RS-232 4 x USB 3.2 Gen 1 (5Gb/s)
- ◆ Internal I/O Interface
1 x KB/MS (1x6 pin) 1 x RS-422/485 (1x4 pin, P=2.0)
1 x LPT (2x13 pin, P=2.54) 4 x RS-232 (2x20 pin, P=2.54)
1 x mSATA (colay SATA 6) 4 x USB 2.0 (2x4 pin, P=2.54)
6 x SATA 6Gb/s (RAID 0/1/5/10 supported)
- ◆ Front Panel
1 x Front panel (2x7 pin, power LED, HDD LED, speaker, power button, reset button)
- ◆ LAN LED
2 x LAN LED (1x2 pin)
- ◆ TPM
1 x TPM (2x10 pin)
- ◆ SMBus
1 x SMBus (1x4 pin)
- ◆ I²C
1 x I²C (1x4 pin)
- ◆ Expansion
1 x PCIe x16 slot
3 x PCIe x4 slot (support PCIe x1)
Default setting: 1 x PCIe x8 Gen 3 + 2 x PCIe x4 Gen 3 signal
Optional setting: 1 x PCIe x16 Gen 3 by BIOS setting
1 x PCIe x1 slot
2 x PCI slot
- ◆ Watchdog Timer: Software programmable, support 1~255 sec. system reset
- ◆ Digital I/O: 8-bit digital I/O (2x5 pin)
- ◆ Fan Connector
1 x CPU fan (1x4 pin) 2 x System fan (1x3 pin)
- ◆ Power Supply: ATX power supply
- ◆ Power Consumption
3.3V@0.57A, 5V@4.50A, 12V@0.14A, Vcore_12V@5.20A, 5VSB@0.19A
(Intel® E3-1240 v3 3.4GHz CPU with 16 GB (4x4 GB) 1333 MHz DDR3 memory)
- ◆ Operating Temperature: -20°C ~ 60°C
- ◆ Storage Temperature: -30°C ~ 70°C
- ◆ Operating Humidity: 5% ~ 95%, non-condensing
- ◆ Dimensions: 244mm x 305mm
- ◆ Weight: GW: 1200g / NW: 700g
- ◆ CE/FCC compliant



Features

- LGA1150 Intel® Xeon® E3/Core™ i3/Pentium®/Celeron® processor supported
- Dual-channel DDR3 1600/1333 MHz support up to 32 GB
- Intel® PCIe GbE with Intel® AMT 9.0 support
- Support PCI Express generation 3.0 at 8GT/s I/O bandwidth
- USB 3.2 Gen 1 (5Gb/s), SATA 6Gb/s and mSATA supported
- High-speed interface for one PCIe x8 or two PCIe x4 add-on cards
- IEI jumper-less function

Packing List

1 x IMBA-C2260-i2 single board computer	2 x SATA cable
1 x I/O shielding	1 x QIG

Ordering Information

Part No.	Description
IMBA-C2260-i2-R11	ATX motherboard supports 22nm LGA1150 Intel® Xeon E3, Core™ i3, Pentium® and Celeron® per Intel® C226, DDR3, VGA, Dual Intel® PCIe GbE, HD Audio, four USB 3.2 Gen 1 (5Gb/s), six SATA 6Gb/s and RoHS
19800-000049-RS	LPT flat cable, 240mm, P=2.54
19800-000075-RS	PS/2 KB/MS cable with bracket, 220mm, P=2.0
CB-USB02-RS	Dual port USB cable with bracket, 300mm, P=2.54
19800-010500-200-RS	USB 3.2 Gen 1 (5Gb/s) cable 457mm with bracket
32102-000100-200-RS	SATA power cable, MOLEX 5264-4P to SATA15P
32205-001203-200-RS	RS-232 cable, 40-pin to four DB-9, 400mm, P=2.54
32205-003800-300-RS	RS-422/485 cable, 200mm, P=2.0
CF-115XA-R10	High performance LGA1155/LGA1156 cooler kit, 1U chassis compatible, 73W
CF-115XE-R10	High performance LGA1155/LGA1156 cooler kit, 95W
DP-DP-R10	DisplayPort to DisplayPort converter board (for IEI iDP connector)
DP-DVI-R10	DisplayPort to DVI-D converter board (for IEI iDP connector)
DP-HDMI-R10	DisplayPort to HDMI converter board (for IEI iDP connector)
DP-LVDS-R10	DisplayPort to 24-bit dual-channel LVDS converter board (for IEI iDP connector)
DP-VGA-R10	DisplayPort to VGA converter board (for IEI iDP connector)
TPM-IN01-R20	20-pin Infineon TPM module, software management tool, firmware v3.17

IMBA-Q870-i2

ATX motherboard supports 22nm LGA1150 Intel® Core™ i7/i5/i3, Pentium® and Celeron® CPU per Intel® Q87, DDR3, triple independent display VGA, DVI-D, HDMI, iDP, USB 3.2 Gen 1 (5Gb/s), SATA 6Gb/s

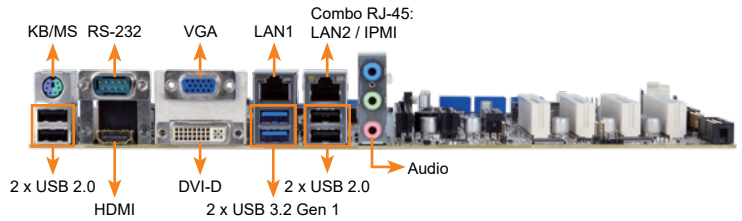
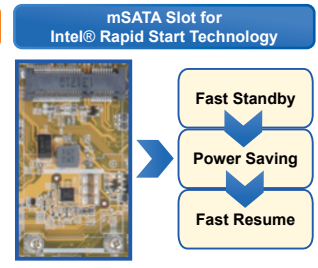
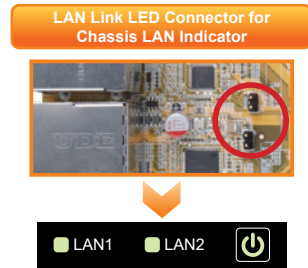
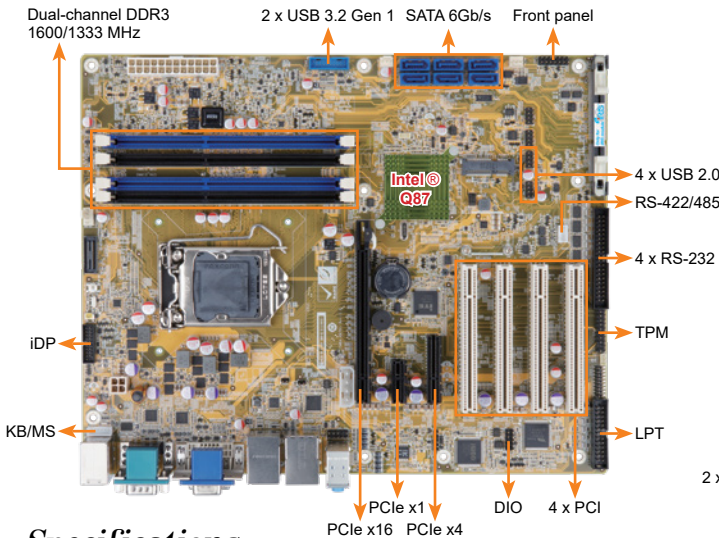

Specifications

- ◆ CPU
LGA1150 4th generation Intel® Core™ i7/i5/i3, Pentium® or Celeron® processor supported
- ◆ Chipset
Intel® Q87
- ◆ Memory
Four 240-pin 1600/1333 MHz dual-channel DDR3 & DDR3L SDRAM unbuffered DIMMs support up to 32 GB
- ◆ BIOS
UEFI BIOS
- ◆ Ethernet
LAN1: Intel® I217LM with Intel® AMT 9.0 support
LAN2: Intel® I210-AT PCIe controller with NCSI support
- ◆ Graphics Engine
Intel® HD Graphics Gen 7.5 supports DX11.1 and OpenCL 1.2, OpenGL 3.2 Full MPEG2, VC1, AVC Decode
- ◆ Display Output
Triple independent display
1 x VGA (up to 1920x1200@60 Hz)
1 x DVI-D (up to 2560x1600@60 Hz)
1 x HDMI (up to 2560x1600@60 Hz)
1 x iDP interface for HDMI, LVDS, VGA, DVI, DP (up to 3840x2160@60 Hz)
- ◆ Audio
Realtek ALC888S HD Audio codec supports 7.1-channel
3 x Audio jacks (line-out, line-in, mic-in) on rear IO
1 x Front audio (2x5 pin)
- ◆ External I/O Interface
1 x KB/MS 2 x USB 3.2 Gen 1 (5Gb/s)
1 x RS-232 4 x USB 2.0
- ◆ Internal I/O Interface
1 x KB/MS (1x6 pin) 2 x USB 3.2 Gen 1 (5Gb/s) (2x10 pin, P=2.0)
1 x LPT (2x13 pin, P=2.54) 4 x RS-232 (2x20 pin, P=2.54)
1 x mSATA (colay SATA 6) 4 x USB 2.0 (2x4 pin, P=2.54)
1 x RS-422/485 (1x4 pin, P=2.54) 6 x SATA 6Gb/s (RAID 0/1/5/10 supported)
- ◆ Front Panel
1 x Front panel (2x7 pin, power LED, HDD LED, speaker, power button, reset button)
- ◆ LAN LED
2 x LAN LED (1x2 pin)
- ◆ TPM
1 x TPM (2x10 pin)
- ◆ SMBus
1 x SMBus (1x4 pin)
- ◆ I²C
1 x I²C (1x4 pin)
- ◆ Expansion
1 x PCIe x16 slot (Gen 3) 1 x PCIe x4 slot
1 x PCIe x1 slot 4 x PCI slots
- ◆ Watchdog Timer
Software programmable, support 1~255 sec. system reset
- ◆ Digital I/O: 8-bit digital I/O (2x5 pin)
- ◆ Fan Connector
1 x CPU smart fan (1x4 pin)
2 x System fan (1x3 pin)
- ◆ Power Supply: ATX Power Supply
- ◆ Power Consumption
3.3V@0.66A, 5V@4.34A, 12V@0.16A, Vcore_12V@4.01A, 5VSB@0.21A
(Intel® Core™ i7-4770K 3.90 GHz CPU with 16 GB (4x 4 GB) 1333 MHz DDR3 memory)
- ◆ Operating Temperature: -20°C ~ 60°C
- ◆ Storage Temperature: -30°C ~ 70°C
- ◆ Operating Humidity: 5% ~ 95%, non-condensing
- ◆ Dimensions: 244mm x 305mm
- ◆ Weight: GW: 1200g / NW: 700g
- ◆ CE/FCC compliant



Features

- LGA1150 4th generation Intel® Core™ i7/i5/i3, Pentium® or Celeron® processor supported
- Dual-channel DDR3 1600/1333 MHz
- Intel® PCIe GbE with Intel® AMT 9.0 support
- Support triple independent display with HDMI, DVI and VGA and iDP
- Support PCI Express generation 3.0 at 8GT/s I/O bandwidth
- USB 3.2 Gen 1 (5Gb/s) and SATA 6Gb/s mSATA supported
- IEI jumper-less function

Packing List

1 x IMBA-Q870-i2 single board computer	2 x SATA cable
1 x I/O shielding	1 x QIG

Ordering Information

Part No.	Description
IMBA-Q870-i2-R10	ATX motherboard supports 22nm LGA1150 Intel® Core™ i7/i5/i3, Pentium® and Celeron® CPU per Intel® Q87, DDR3, triple independent display VGA/DVI-D/HDMI/iDP, dual Intel® GbE, USB 3.2 Gen 1 (5Gb/s), SATA 6Gb/s, audio and RoHS
IMBA-Q870-ECO-R10	LGA1150 Intel® Core™ i7/i5/i3, Pentium® and Celeron® CPU per Intel® Q87, DDR3, triple independent display VGA, DVI-D, HDMI, iDP, USB 3.2 Gen 1 (5Gb/s), SATA 6Gb/s, ECO packing, RoHS (10 pcs/pack)
19800-000049-RS	LPT flat cable, 240mm, P=2.54
19800-000075-RS	PS/2 KB/MS cable with bracket, 220mm, P=2.0
CB-USB02-RS	Dual port USB cable with bracket, 300mm, P=2.54
19800-010500-200-RS	USB 3.2 Gen 1 (5Gb/s) cable 457mm with bracket
32102-000100-200-RS	SATA power cable, MOLEX 5264-4P to SATA15P
32205-001203-200-RS	RS-232 cable, 40-pin to four DB-9, 400mm, P=2.54
32205-003800-300-RS	RS-422/485 cable, 200mm, P=2.0
CF-115XA-R10	High performance LGA1155/LGA1156 cooler kit, 1U chassis compatible, 73W
CF-115XE-R10	High performance LGA1155/LGA1156 cooler kit, 95W
DP-DP-R10	DisplayPort to DisplayPort converter board (for IEI iDP connector)
DP-DVI-R10	DisplayPort to DVI-D converter board (for IEI iDP connector)
DP-HDMI-R10	DisplayPort to HDMI converter board (for IEI iDP connector)
DP-LVDS-R10	DisplayPort to 24-bit dual-channel LVDS converter board (for IEI iDP connector)
DP-VGA-R10	DisplayPort to VGA converter board (for IEI iDP connector)
TPM-IN01-R20	20-pin Infineon TPM module, software management tool, firmware v3.17

IMB-H110

microATX Motherboard supports 14nm LGA1151 Intel® Core™ i7/i5/i3, Pentium® or Celeron® processor, DDR4, Dual Independent Displays VGA/ DVI-I/LVDS, Dual GbE LAN, USB 3.2 Gen 1 (5Gb/s), SATA 6Gb/s, HD Audio and RoHS

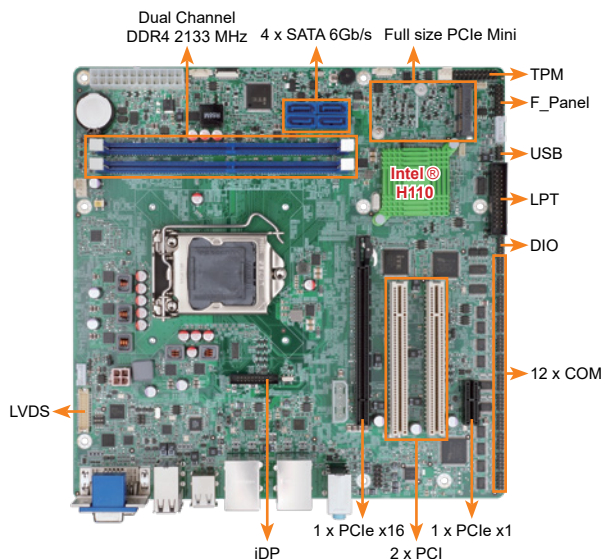

Specifications

- ◆ CPU
LGA 1151 socket supports Intel® 6th/7th generation Core™ i7/i5/i3, Pentium® or Celeron® processor
- ◆ Chipset
Intel® skylake H110
- ◆ Memory
Two 288-pin 2133MHz Dual-channel DDR4 SDRAM Unbuffered DIMM supported up to 64GB
- ◆ BIOS
UEFI BIOS
- ◆ Graphics Engine
Intel® HD Graphics Gen 9 Engines with Low power 16 execution unit, supports DX2015, OpenGL 5.X and OpenCL2.x, ES 2.0
- ◆ Display Output
Dual independent display
1 x VGA (up to 1920x1200@60Hz)
1 x DVI-I (up to 1920x1200@ 60Hz)
1 x 18/24-bit dual-channel LVDS (up to 1920x1200@60Hz)
1 x iDP interface for HDMI, LVDS, VGA, DVI, DP (up to 3840x2160@60Hz)
- ◆ Ethernet
LAN1: RTL 8111GN controller
LAN2: RTL 8111GN controller
- ◆ External I/O Interface
4 x USB 3.2 Gen 1 (5Gb/s)
6 x USB 2.0
- ◆ Internal I/O Interface
1 x KB/MS (1x6 pin) 2 x RS-232/422/485 (2x5 pin, P=2.0)
1 x LPT (2x13 pin, P=2.54) 2 x USB 2.0 (2x4 pin, P=2.0)
4 x SATA 6Gb/s 10 x RS-232 (2x5 pin, P=2.0)
- ◆ SMBus
1 x SMBus (1x4 pin)
- ◆ TPM
1 x TPM (2x10 pin)
- ◆ Audio
Realtek ALC888S HD Audio codec supports 7.1-channel
3 x Audio jacks (line-out, line-in, mic-in) on rear IO
1 x Front audio (2x5 pin)
- ◆ Front Panel
1 x Front Panel (2x7 pin, Power LED, HDD LED, Speaker, Power Button, Reset Button)
- ◆ LAN LED
2 x LAN LED (1x2 pin)
- ◆ I²C
1 x I²C (1x4 pin)
- ◆ Expansion
1 x PCIe x16 slot (Gen3) 1 x Full/Half-size PCIe Mini card slot
1 x PCIe x1 slot (Gen2) 2 x PCI slot
- ◆ Watchdog Timer
Software programmable, supports 1~255 sec. system reset
- ◆ Digital I/O: 8-bit Digital I/O (2x5 pin)
- ◆ Fan Connector
1 x CPU smart fan (1x4 pin)
1 x System fan (1x3 pin)
- ◆ Power Supply: ATX/AT Power Supply
- ◆ Power Consumption
3.3V@ 0.93A, 5V@2.99A, 12V@6.88A, 5VSB@0.02A (Intel® Core™ i7-6700K 4.0GHz CPU with 16GB (two 8GB) 2133 MHz DDR4 memory)
- ◆ Operating Temperature: -20°C ~ 60°C
- ◆ Storage Temperature: -30°C ~ 70°C
- ◆ Operating Humidity: 5% ~ 9%, non-condensing
- ◆ Weight: GW: 1200g / NW: 700g
- ◆ CE/FCC compliant

Multiple Expansion Support

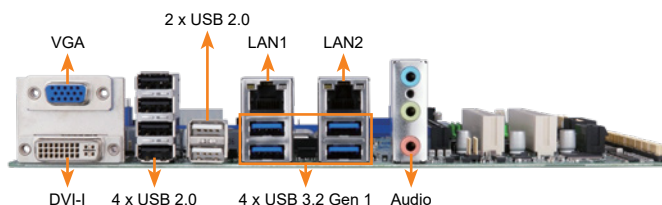

Features

- LGA 1151 Intel® 6th/7th generation Core™ i7/i5/i3, Pentium® or Celeron® processor supported
- Dual-channel DDR4 2133MHz support up to 64GB
- Support Dual displays via VGA/DVI-I/LVDS
- USB 3.2 Gen 1 (5Gb/s) and SATA 6Gb/s supported
- 12 COM & 12 USB

Packing List

1 x IMB-H110 motherboard	2 x SATA cable
1 x I/O shielding	1 x QIG

Ordering Information

Part No.	Description
IMB-H110-R10	microATX motherboard supports 14nm LGA1151 Intel® Core™ i7/i5/i3, Pentium® or Celeron® processor supported, DDR4, Dual independent displays VGA/DVI-I/LVDS, Dual GbE LAN, USB 3.2 Gen 1 (5Gb/s), SATA 6Gb/s, HD Audio and RoHS
IMB-H110-ECO-R10	microATX Motherboard supports 14nm LGA1151 6th Generation Intel® Core™ i7/i5/i3, Pentium® or Celeron® processor per Intel® H110, DDR4, VGA/DVI-I/LVDS, Dual GbE LAN, USB 3.2 Gen 1 (5Gb/s), SATA 6Gb/s, HD Audio, ECO Packing and RoHS (10 pcs/pack)
19800-000049-RS	LPT flat cable, 240mm, P=2.54
19800-000075-RS	PS/2 KB/MS cable with bracket, 220mm, P=2.0
19800-000200-100-RS	RS-232 cable with bracket, Dual 10-pin to dual DB-9, 300mm, P=2.0
32102-000100-200-RS	SATA power cable, MOLEX 5264-4P to SATA15P
CF-115XA-R10	High performance LGA1155/LGA1156 cooler kit, 1U chassis compatible, 73W
CF-115XE-R10	High performance LGA1155/LGA1156 cooler kit, 95W
DP-DP-R10	DisplayPort to DisplayPort converter board (for IEI iDP connector)
DP-DVI-R10	DisplayPort to DVI-D converter board (for IEI iDP connector)
DP-HDMI-R10	DisplayPort to HDMI converter board (for IEI iDP connector)
DP-LVDS-R10	DisplayPort to 24-bit dual-channel LVDS converter board (for IEI iDP connector)
DP-VGA-R10	DisplayPort to VGA converter board (for IEI iDP connector)
TPM-IN02-R20	20-pin Infineon TPM 2.0 module, software management tool, firmware v5.5

IMB-Q870-i2

microATX motherboard supports 22nm LGA1150 Intel® Core™ i7/i5/i3, Pentium® and Celeron® CPU per Intel® Q87, DDR3, HDMI, DVI-D, VGA, iDP, USB 3.2 Gen 1 (5Gb/s), SATA 6Gb/s, six serial ports

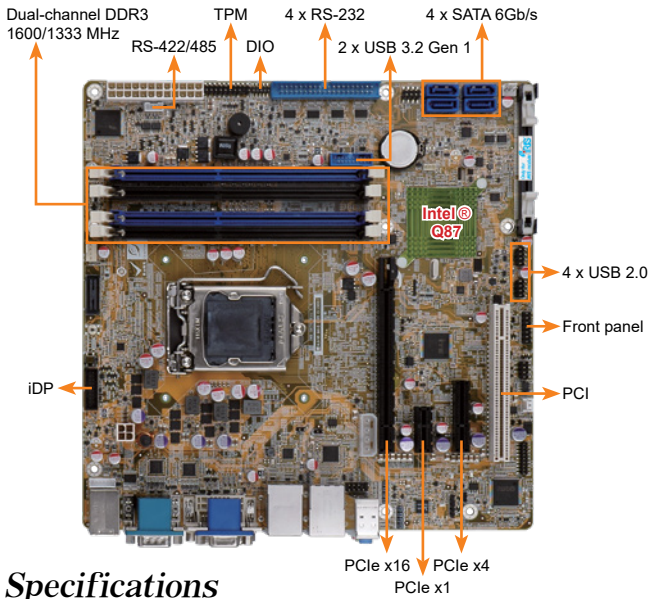

New and More Powerful Graphics

2nd Generation Intel® Core™ Processor (Sandy Bridge)	3rd Generation Intel® Core™ Processor (Ivy Bridge)	4th Generation Intel® Core™ Processor (Haswell)	
Intel® HD Graphics 3000 series	Intel® HD Graphics 4000 series	GT3-Intel® HD Graphics 5000 series	Core i7
Intel® HD Graphics 2000 series	Intel® HD Graphics 2500 series	GT2-Intel® HD Graphics 4000 series	Core i5/ Core i3
Intel® HD Graphics series	Intel® HD Graphics series	GT1-Intel® HD Graphics series	Celeron/ Pentium

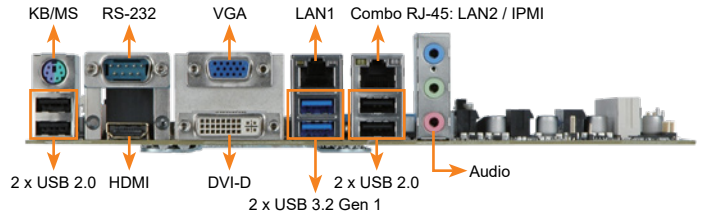

Specifications

- ◆ CPU: LGA1150 socket supports Intel® 4th generation Core™ i7/i5/i3, Pentium® or Celeron® processor
- ◆ Chipset: Intel® Q87
- ◆ Memory: Four 240-pin 1600/1333 MHz dual-channel DDR3 & DDR3L SDRAM unbuffered DIMMs support up to 32 GB
- ◆ BIOS: UEFI BIOS
- ◆ Ethernet: LAN1: Intel® I217LM with Intel® AMT 9.0 support; LAN2: Intel® I210-AT PCIe controller with NCSI support
- ◆ Graphics Engine: Intel® HD Graphics Gen 7.5 supports DX11.1 and OpenCL 1.2, OpenGL 4.3; Full MPEG2, VC1, AVC Decode
- ◆ Display Output: Triple independent display; 1 x VGA (up to 1920x1200@60Hz); 1 x DVI-D (up to 2560x1600@60Hz); 1 x HDMI (up to 2560x1600@60Hz); 1 x iDP interface for HDMI, LVDS, VGA, DVI, DP (up to 3840x2160@60Hz)
- ◆ Audio: Realtek ALC888S HD Audio codec supports 7.1-channel; 3 x Audio jacks (line-out, line-in, mic-in) on rear IO; 1 x Front audio (2x5 pin)
- ◆ External I/O Interface: 1 x KB/MS, 2 x USB 3.2 Gen 1 (5Gb/s); 1 x RS-232, 4 x USB 2.0
- ◆ Internal I/O Interface: 1 x KB/MS (1x6 pin), 4 x SATA 6Gb/s (RAID 0/1/5/10 supported); 1 x RS-422/485 (1x4 pin, P=2.0), 4 x RS-232 (2x5 pin, P=2.54); 2 x USB 3.2 Gen 1 (5Gb/s) (2x10 pin), 4 x USB 2.0 (2x4 pin, P=2.54)
- ◆ Front Panel: 1 x Front panel (2x7 pin, power LED, HDD LED, speaker, power button, reset button)
- ◆ LAN LED: 2 x LAN LED (1x2 pin)
- ◆ TPM: 1 x TPM (2x10 pin)
- ◆ SMBus: 1 x SMBus (1x4 pin)
- ◆ I²C: 1 x I²C (1x4 pin)
- ◆ Expansion: 1 x PCIe x16 slot (Gen 3), 1 x PCIe x4 slot; 1 x PCIe x1 slot, 1 x PCI slot
- ◆ Watchdog Timer: Software programmable, support 1~255 sec. system reset
- ◆ Digital I/O: 8-bit digital I/O (2x5 pin)
- ◆ Fan Connector: 1 x CPU smart fan (1x4 pin), 2 x System smart fan (1x3 pin)
- ◆ Power Supply: ATX power supply
- ◆ Power Consumption: 3.3V@0.53A, 5V@4.96A, 12V@0.12A, Vcore_12V@3.95A, 5VSB@0.18A (Intel® Core™ i7-4770K 3.90 GHz CPU with 16 GB (4x4 GB) 1333 MHz DDR3 memory)
- ◆ Operating Temperature: -20°C ~ 60°C
- ◆ Storage Temperature: -30°C ~ 70°C
- ◆ Operating Humidity: 5% ~ 95%, non-condensing
- ◆ Dimensions: 244mm x 244mm
- ◆ Weight: GW: 1200g / NW: 700g
- ◆ CE/FCC compliant



Features

- LGA1150 4th generation Intel® Core™ i7/i5/i3, Pentium® or Celeron® processor supported
- Dual-channel DDR3 1600/1333 MHz supported
- Intel® PCIe GbE with Intel® AMT 9.0 support
- Support triple display via HDMI, DVI, VGA and iDP
- Support PCI Express generation 3.0 at 8GT/s I/O bandwidth
- USB 3.2 Gen 1 (5Gb/s) and SATA 6Gb/s supported
- IEI jumper-less function

Packing List

1 x IMB-Q870-i2 single board computer	2 x SATA cable
1 x I/O shielding	1 x QIG

Ordering Information

Part No.	Description
IMB-Q870-i2-R10	microATX motherboard supports 22nm LGA1150 Intel® Core™ i7/i5/i3/Pentium® and Celeron® CPU per Intel® Q87, DDR3, dual Intel® PCIe GbE, HDMI, DVI-D, VGA, DP, audio, SATA 6Gb/s, USB 3.2 Gen 1 (5Gb/s), six serial ports, iRS-2400 and RoHS
19800-000049-RS	LPT flat cable, 240mm, P=2.54
19800-000075-RS	PS/2 KB/MS cable with bracket, 220mm, P=2.0
CB-USB02-RS	Dual port USB cable with bracket, 300mm, P=2.54
19800-010500-200-RS	USB 3.2 Gen 1 (5Gb/s) cable with bracket, 450mm
32102-000100-200-RS	SATA power cable, MOLEX 5264-4P to SATA15P
32205-001203-200-RS	RS-232 cable, 40-pin to four DB-9, 400mm, P=2.54
32205-003800-300-RS	RS-422/485 cable, 200mm, P=2.0
CF-115XA-R10	High performance LGA1155/LGA1156 cooler kit, 1U chassis compatible, 73W
CF-115XE-R10	High performance LGA1155/LGA1156 cooler kit, 95W
DP-DP-R10	DisplayPort to DisplayPort converter board (for IEI iDP connector)
DP-DVI-R10	DisplayPort to DVI-D converter board (for IEI iDP connector)
DP-HDMI-R10	DisplayPort to HDMI converter board (for IEI iDP connector)
DP-LVDS-R10	DisplayPort to 24-bit dual-channel LVDS converter board (for IEI iDP connector)
DP-VGA-R10	DisplayPort to VGA converter board (for IEI iDP connector)
TPM-IN01-R20	20-pin Infineon TPM module, software management tool, firmware v3.17

IMB-H810-i2-R11

microATX motherboard supports 22nm LGA1150 Intel® Core™ i7/i5/i3, Pentium®, Celeron® CPU per Intel® H81, DDR3, VGA, dual GbE, LPT, COM, SATA 6Gb/s

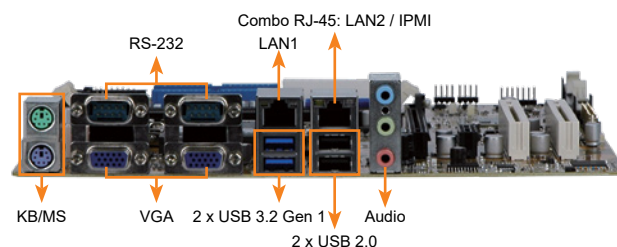
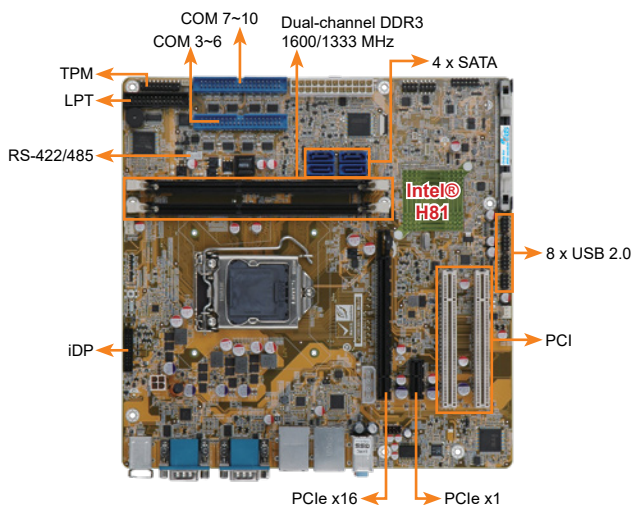

Specifications

- ◆ CPU
LGA1150 socket supports Intel® 4th generation Core™ i7/i5/i3, Pentium® or Celeron® processor
- ◆ Chipset
Intel® H81
- ◆ Memory
Two 240-pin 1600/1333 MHz dual-channel DDR3 & DDR3L SDRAM unbuffered DIMMs support up to 16 GB
- ◆ BIOS
UEFI BIOS
- ◆ Ethernet
LAN1: Intel® I217LM with Intel® AMT9.0 support
LAN2: Intel® I210-AT PCIe controller with NCSI support
- ◆ Graphics Engine
Intel® HD Graphics Gen 7.5 supports DX11.1 and OpenCL 1.2, OpenGL 4.3
Full MPEG2, VC1, AVC Decode
- ◆ Display Output
Dual independent display
2 x VGA (up to 1920x1200@60Hz)
1 x iDP interface for HDMI, LVDS, VGA, DVI, DP (up to 3840x2160@60Hz)
- ◆ Audio
Realtek ALC888S HD Audio codec supports 7.1-channel
3 x Audio jacks (line-out, line-in, mic-in) on rear IO
1 x Front audio (2x5 pin)
- ◆ TPM
1 x TPM (2x10 pin)
- ◆ SMBus
1 x SMBus (1x4 pin)
- ◆ I²C
1 x I²C (1x4 pin)
- ◆ LAN LED: 2 x LAN LED (1x2 pin)
- ◆ External I/O Interface

1 x KB/MS	2 x USB 2.0
2 x RS-232	2 x USB 3.2 Gen 1 (5Gb/s)
- ◆ Internal I/O Interface

1 x LPT (2x13 pin, P=2.54)	2 x SATA 6Gb/s
1 x RS-422/485 (1x4 pin, P=2.0)	8 x RS-232 (2x20 pin, P=2.54)
2 x SATA 3Gb/s	8 x USB 2.0 (2x4 pin, P=2.54)
- ◆ Front Panel
1 x Front panel (2x7 pin, power LED, HDD LED, speaker, power button, reset button)
- ◆ Expansion
1 x PCIe x16 slot (Gen 3)
1 x PCIe x1 slot
2 x PCI slot
- ◆ Watchdog Timer
Software programmable, supports 1~255 sec system reset
- ◆ Fan Connector
1 x CPU smart fan (1x4 pin)
1 x System smart fan (1x3 pin)
- ◆ Power Supply
ATX power supply
- ◆ Power Consumption
3.3V@0.64A, 5V@4.20A, 12V@0.14A, Vcore_12V@3.88A, 5VSB@0.20A
(Intel® Core™ i7-4770K 3.90 GHz CPU with 8 GB (two 4 GB) 1333 MHz DDR3 memory)
- ◆ Operating Temperature: -20°C ~ 60°C
- ◆ Storage Temperature: -30°C ~ 70°C
- ◆ Operating Humidity: 5% ~ 95%, non-condensing
- ◆ Dimensions: 244mm x 244mm
- ◆ Weight: GW: 1200g / NW: 680g
- ◆ CE/FCC compliant

Features

- LGA1150 4th generation Intel® Core™ i7/i5/i3, Pentium® or Celeron® processor supported
- Dual-channel DDR3 1333/1600 MHz support up to 16 GB
- Intel® HD Graphics technology integrates high-performance graphics and media processing
- Supports legacy PCI 32-bit 33/66 MHz
- Ten COM ports, USB 3.2 Gen 1 (5Gb/s) and SATA supported
- TPM V1.2 hardware security function supported by TPM module
- IEI jumper-less function

Packing List

1 x IMB-H810-i2 single board computer	2 x SATA cable
1 x I/O shielding	1 x QIG

Ordering Information

Part No.	Description
IMB-H810-i2-R11	microATX motherboard supports 22nm LGA1150 Intel® Core™ i7/i5/i3/Pentium® and Celeron® CPU per Intel® H81, DDR3, VGA, Dual Intel® PCIe GbE, USB 2.0, PCI, COM, SATA 6Gb/s, LPT, HD Audio, iRIS-2400 and RoHS
IMB-H810-ECO-R11	LGA1150 Intel® Core™ i7/i5/i3, Pentium® and Celeron® CPU per Intel® H81, DDR3, VGA, Dual PCIe GbE, USB 2.0, COM, LPT, SATA 6Gb/s, HD Audio, ECO packing, RoHS (10 pce/pack)
19800-000049-RS	LPT flat cable, 240mm, P=2.54
19800-000075-RS	PS/2 KB/MS cable with bracket, 220mm, P=2.0
19800-003100-100-RS	Dual port USB cable with bracket, 30mm, P=2.54
19800-010500-200-RS	USB 3.2 Gen 1 (5Gb/s) cable with bracket, 450mm
32102-000100-200-RS	SATA power cable, MOLEX 5264-4P to SATA15P
32205-001203-200-RS	RS-232 cable, 40-pin to four DB-9, 400mm, P=2.54
32205-003801-100-RS	RS-232/422/485, RS-422/485 cable, 500mm
CF-115XA-R10	High performance LGA1155/LGA1156 cooler kit, 1U chassis compatible, 73W
CF-115XE-R10	High performance LGA1155/LGA1156 cooler kit, 95W
DP-DP-R10	DisplayPort to DisplayPort converter board (for IEI iDP connector)
DP-DVI-R10	DisplayPort to DVI-D converter board (for IEI iDP connector)
DP-HDMI-R10	DisplayPort to HDMI converter board (for IEI iDP connector)
DP-LVDS-R10	DisplayPort to 24-bit dual-channel LVDS converter board (for IEI iDP connector)
DP-VGA-R10	DisplayPort to VGA converter board (for IEI iDP connector)
TPM-IN01-R20	20-pin Infineon TPM module, software management tool, firmware v3.17

Dimensions (Unit: mm)

IMBA-C2360-i2

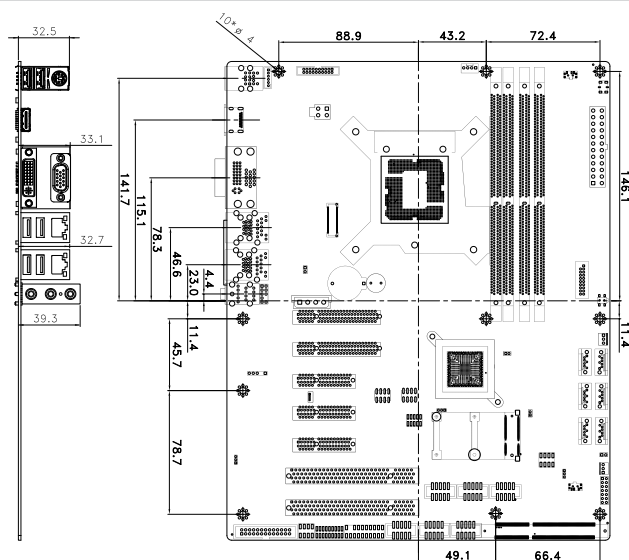

IMBA-Q170-i2

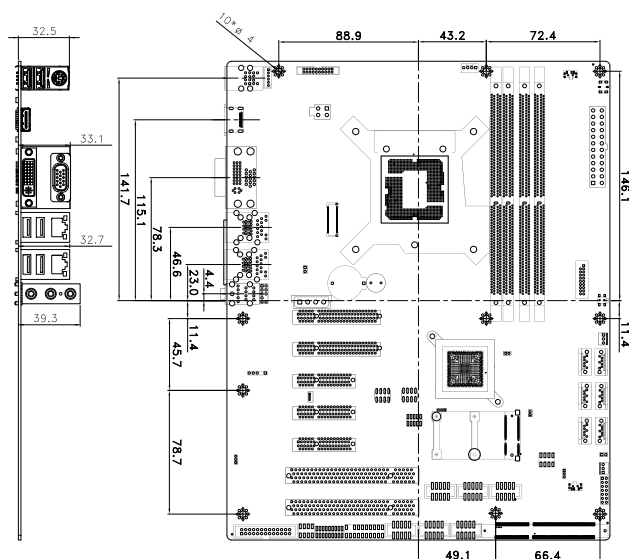

IMBA-H110

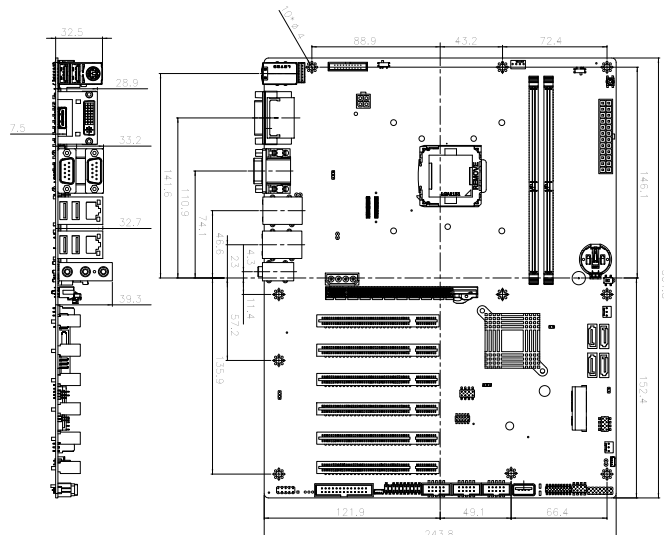

Dimensions (Unit: mm)

IMBA-C2260-i2-R11

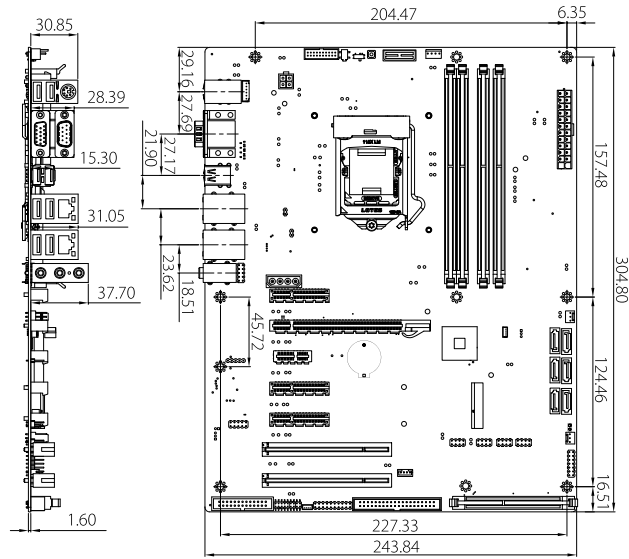

IMBA-H810

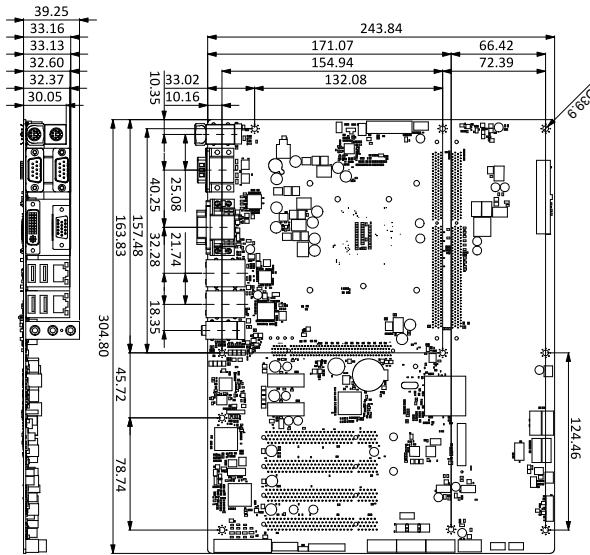

IMBA-Q870-i2

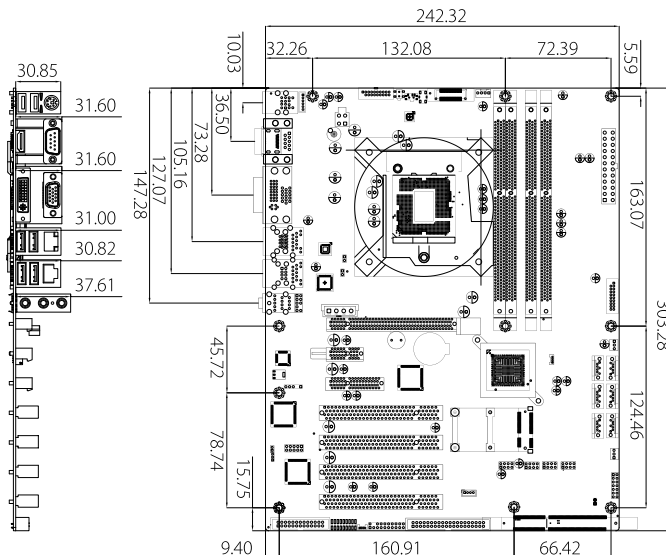

Dimensions (Unit: mm)

IMB-H110

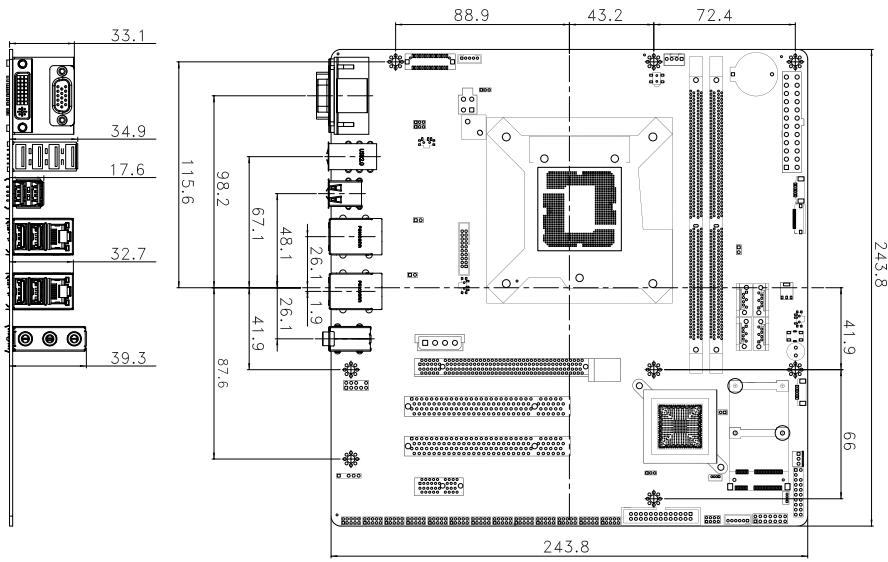

IMB-Q870-i2

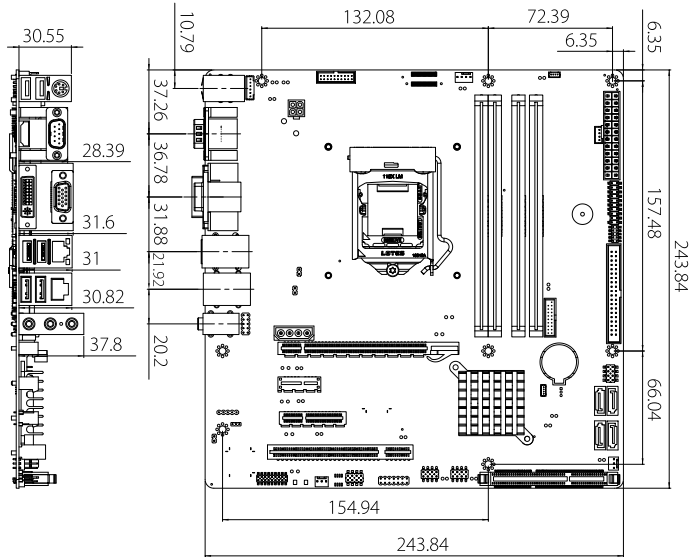

IMB-H810-i2-R11

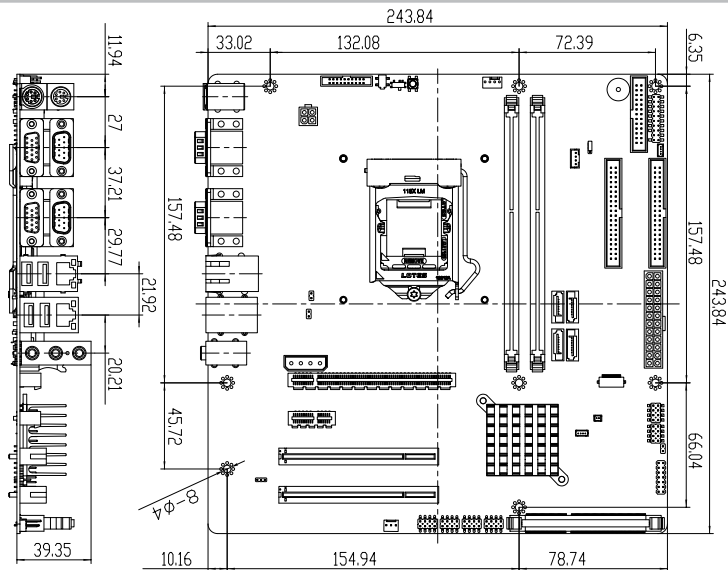

Mini-ITX Selection Guide

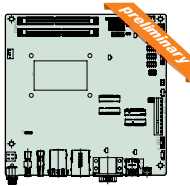

Model Name	KINO-ADL-P	KINO-EHL-J6412	KINO-TGL-U	KINO-DH420	KINO-KX
CPU Socket	On Board	On Board	On Board	LGA1200	On Board
CPU Type	12th Gen. Intel® mobile Alder Lake-P on-board processor	Intel® Celeron® J6412 on-board SoC	Intel® 11th Gen. Core™ i7/i5/i3, Celeron® UP3 processor (code name: Tiger Lake)	10th generation Intel® Core™ i9/i7/i5/i3/Pentium® and Celeron® processor	Zhaoxin Kaixin KX-6000 series 8-core processor Zhaoxin KX-U6580/U6780A on-board SoC
Chipset	12th Gen. Intel® mobile Alder Lake-P on-board processor	Intel® Celeron® J6412 on-board SoC	Intel® 11th Gen. Core™ i7/i5/i3, Celeron® UP3 processor (code name: Tiger Lake)	Intel® H420E	Zhaoxin ZX-200
Memory	Two 260-pin 3200 MHz DDR4 SO-DIMM (system max.64GB)	Onboard LPDDR4x-3200MHz 4GB (system max. 8GB)	2 x 260-pin 3200 MHz DDR4 SO-DIMM (system max. 64GB)	2 x 260-pin 2933 MHz dual-channel DDR4 SDRAM SO-DIMMs (system max. 64 GB)	2 x 260-pin 2666 MHz dual-channel DDR4 SDRAM SO-DIMMs (system max. 64 GB)
Display Interface	Quadruple independent display 1 x HDMI 1.4 1 x DP 1.4 2 x Type-C DP with Thunderbolt 1 x IEI IDPM 3040 slot (only for IEI eDP/ LVDS/ VGA module)	Triple independent display 1 x HDMI 1.4 1 x DP 1.4 1 x IEI IDPM 3040 slot (only for IEI eDP/LVDS/VGA module)	Triple independent display 1 x HDMI 1.4 1 x DP 1.4 1 x IEI IDPM 3040 slot (only for IEI eDP/LVDS/VGA module)	Dual independent display 1 x DP 1.4 1 x HDMI 1.4	Dual independent display 1 x VGA 1 x DVI-I
Ethernet	LAN1: Intel® I225V 2.5GbE controller LAN2: Intel® I225V 2.5GbE controller LAN3: Intel® I225V 2.5GbE controller	LAN1: Intel® I225V 2.5GbE controller LAN2: Intel® I225V 2.5GbE controller	LAN1: Intel® I225V 2.5GbE controller LAN2: Intel® I225V 2.5GbE controller	LAN1: Intel® I225V 2.5GbE controller LAN2: Intel® I225V 2.5GbE controller LAN3: Intel® I225V 2.5GbE controller	LAN1: Realtek RTL8111H PCIe GbE controller LAN2: Realtek RTL8111H PCIe GbE controller
I/O Interface	3 x USB 3.2 Gen 2 (Type A) 2 x USB4 (Type C) 2 x RS-232/422/485 4 x USB 2.0 pin header 4 x RS-232 pin header	2 x USB 3.2 Gen 2 (Type A) 2 x USB 2.0 (Type A) 2 x RS-232 4 x USB 2.0 (pin header) 4 x RS-422/485 (pin header)	4 x USB 3.2 Gen 2 (Type A) 1 x RS-232/422/485 pin header 2 x USB 2.0 pin header 5 x RS-232 pin header	2 x RS-232 2 x USB 2.0 4 x USB 3.2 Gen 1 Type A 1 x RS-232 pin header 1 x RS-422/485 pin header 2 x USB 2.0 pin header	1 x KB/MS 4 x USB 3.2 Gen 1 Type A 10 x USB 2.0 10 x RS-232 pin header
Storage Interface	2 x SATA 6Gb/s	1 x SATA 6Gb/s 1 x M.2 (B key, support NVMe SSD)	2 x SATA 6Gb/s	2 x SATA 6Gb/s (No RAID) 1 x M.2 (B key, support NVMe SSD)	4 x SATA 6Gb/s (RAID 0/1/5/10 supported)
Audio	1 x IAUDIO, support IEI AC-KIT-888S Audio Module (2 x 5 pin)	1 x IAUDIO, support IEI AC-KIT-888S Audio Module (2 x 5 pin)	1 x IAUDIO, support IEI AC-KIT-888S Audio Module (2 x 5 pin)	Realtek ALC888S HD Audio codec	Realtek ALC888S HD Audio codec
Digital I/O	12-bit programmable I/O (12-bit GPIO is for programming I/O)	12-bit programmable I/O (12-bit GPIO is for programming I/O)	12-bit programmable I/O (12-bit GPIO is for programming I/O)	12-bit programmable I/O (12-bit GPIO is for programming I/O)	N/A
Power Consumption	TBD	TBD	9V@9.19A, 12V@7.768A, 28V@3.119A, 36V@2.459A (Intel® Core™ i7-1185G7E CPU with one 8 GB 2933 MHz DDR4 SO-DIMM)	12V@12.408A (Intel® Core™ i7-10900E CPU with two 32 GB 2933 MHz DDR4 memory, EuP/ErP mode disabled)	12V@3.38A, 3.3V@0.62A, 5V@9.81A, 5VSB@0.03A (Zhaoxin KX-U6580 2.5 GHz CPU with 8 GB 2400 MHz DDR4 memory)
Watchdog Timer	Software programmable and supports 1~255 sec. system reset				
Operation Environment	Temperature Range: 0°C ~ 60°C (32°F ~ 140°F) Relative Humidity: 5% ~ 95%, non-condensing	Temperature Range: 0°C ~ 60°C (32°F ~ 140°F) Relative Humidity: 5% ~ 95% non-condensing	Temperature Range: 0°C ~ 60°C (32°F ~ 140°F) Relative Humidity: 5% ~ 95%, non-condensing	Temperature Range: 0°C ~ 60°C (32°F ~ 140°F) Relative Humidity: 5% ~ 95%, non-condensing	Temperature Range: -20°C ~ 60°C (-4°F ~ 140°F) Relative Humidity: 5% ~ 95%, non-condensing
Expansion Slot	1 x PCIe x4 slot, open-ended 1 x M.2 A key 1 x M.2 B key 1 x M.2 M key	1 x PCIe x4 slot, open-ended 1 x M.2 A key 1 x M.2 B key w/ SIM holder	1 x PCIe x4 slot, open-ended (PCIe Gen3 x4 signal)	1 x PCIe x16 (Gen3) 1 x M.2 (B key) 1 x M.2 (A key)	1 x PCIe x16 slot (x8 Gen3 signal) 1 x Full-size PCIe Mini Slot
CPU Cooler	Cooler/Heatsink	Cooler/Heatsink	Cooler/Heatsink	CF-115XA-R10 CF-1156C-R20 CF-1156D-R30 CF-115XE-R10	Cooler

Mini-ITX Selection Guide

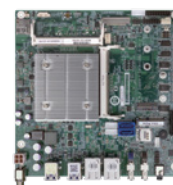

Model Name	KINO-DH310	KINO-DH110	KINO-DAL	tKINO-AL
CPU Socket	LGA1151	LGA1151	On Board	On Board
CPU Type	8th generation Intel® Core™ i7/i5/i3 Pentium® and Celeron® processor	6th/7th generation Intel® Core™ i7/i5/i3 Pentium® and Celeron® processor	Intel® Atom™/Celeron®/ Pentium® on-board SoC	Intel® Atom™/Celeron®/Pentium® on-board SoC
Chipset	Intel® H310	Intel® H110	Intel® Atom™/Celeron®/Pentium® on-board SoC	Intel® Atom™/Celeron®/Pentium® on-board SoC
Memory	2 x 260-pin 2666/2400 MHz dual-channel DDR4 SDRAM SO-DIMMs (system max. 64 GB)	2 x 260-pin 2666/2400 MHz dual-channel DDR4 SDRAM SO-DIMMs (system max. 64 GB)	2 x 204-pin 1866/1600 MHz single-channel DDR3L SO-DIMM (system max. 8 GB)	2 x 204-pin 1866/1600 MHz single-channel DDR3L SO-DIMM (system max. 8 GB)
Display Interface	Dual independent display 2 x HDMI 1 x internal DisplayPort (180°)	Dual independent display 1 x DP++ 1 x HDMI 1 x iDP interface	Triple independent display 1 x VGA 1 x HDMI 1 x 18/24-bit dual-channel LVDS	Triple independent display 2 x DP++ 1 x eDP
Ethernet	Dual LAN: RTL8111H	LAN1: Intel® I219LM PCIe controller LAN2: Intel® I211 PCIe controller	LAN1: Intel® I211 PCIe controller LAN2: Intel® I211 PCIe controller	Dual LAN: RTL8111
I/O Interface	4 x USB 3.2 Gen 1 Type A 2 x RS-232 1 x KB/MS pin header 1 x RS-422/485 pin header 1 x RS-232 pin header 4 x USB 2.0 pin header	4 x USB 3.2 Gen 1 Type A 1 x RS-232/422/485 1 x KB/MS pin header 2 x RS-232 pin header 4 x USB 2.0 pin header	4 x USB 3.2 Gen 1 Type A 2x RS-232/422/485 1 x internal USB 2.0 (180° Type-A) 1 x KB/MS pin header 4 x RS-232 pin header 4 x USB 2.0 pin header	4 x USB 3.2 Gen 1 Type A 2x RS-232/422/485 pin header 1 x KB/MS pin header 4 x RS-232 pin header 2 x USB 2.0 pin header
Storage Interface	2 x SATA 6Gb/s	2 x SATA 6Gb/s	2 x SATA 6Gb/s 1 x 8 GB eMMC (optional)	2 x SATA 6Gb/s 1 x 8 GB eMMC (optional)
Audio	Realtek ALC888S HD Audio codec			Realtek ALC269 HD Audio codec
Digital I/O	8-bit programmable digital I/O			
Power Consumption	12V@11.32A (Intel® Core™ i7-8700 up to 4.60 GHz CPU with two 8GB 2666MHz DDR4 memory)	12V@12.16A (3.4GHz Intel® Core™ i7-6700 with two 8GB 2133MHz 16GB DDR4 memory)	12V@3.62A (Intel® Pentium® N4200 CPU with two 8GB 1600MHz DDR3L memory)	12V@2.58A (Intel® Pentium® N4200 CPU with two 8GB 1600MHz DDR3L memory)
Watchdog Timer	Software programmable and supports 1~255 sec. system reset			
Operation Environment	Temperature Range: -20°C ~ 60°C (-4°F ~ 140°F) Relative Humidity: 5% ~ 95% non-condensing		Temperature Range: KINO-DAL: -20°C ~ 70°C (-4°F ~ 158°F) KINO-DALW2: -40°C ~ 85°C (-40°F ~ 185°F) Relative Humidity: 5% ~ 95% non-condensing	Temperature Range: -20°C ~ 70°C (-4°F ~ 158°F) Relative Humidity: 5% ~ 95% non-condensing
Expansion Slot	1 x PCIe x16 1 x M.2 M key (2280, PCIe Gen2 x2 only) 1 x M.2 A Key (2230, PCIe x1 & USB 2.0)	1 x Full-size PCIe Mini card 1 x M.2 B key 1 x PCIe x16	1 x PCIe x1 1 x Full/Half-size PCIe Mini card 1 x M.2 B key	1 x PCIe x1 1 x Full/Half-size PCIe Mini card 1 x M.2 B key
CPU Cooler	CF-115XA-R10 CF-1156C-R20 CF-1156D-R30 CF-115XE-R10	CF-1156C-R20 CF-1156D-R30 CF-115XE-R10	Heatsink	Heatsink

Mini-ITX Selection Guide

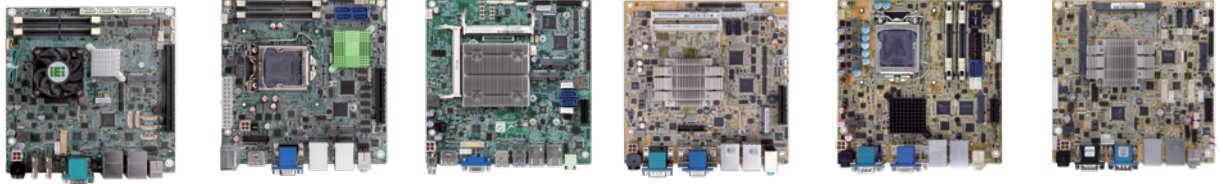

Model Name	KINO-DQM170	KINO-AQ170	tKINO-BW	KINO-DBT	KINO-DH810	eKINO-BT
CPU Socket	On board	LGA1151	On board	On board	LGA1150	On board
CPU Type	6th generation Intel® Core™ i7/i5/i3 and Celeron® processor	6th/7th generation Intel® Core™ i7/i5/i3, Pentium® and Celeron® processor	Intel® Pentium®/Celeron® on board SoC	Intel® Atom™/Celeron® on board SoC (Code name: Bay Trail)	Intel® Core™ i7/i5/i3, Pentium®, Celeron® processor	Intel® Atom™/Celeron® on board SoC (Code name: Bay Trail)
Chipset	Intel® QM170	Intel® Q170	Intel® Pentium®/Celeron® on-board SoC	Intel® Atom™/Celeron® on-board SoC	Intel® H81	Intel® Atom™/Celeron® on-board SoC
Memory	Two 260-pin 2133 MHz dual-channel DDR4 SDRAM SO-DIMMs (system max. 64 GB)	Two 260-pin 2133 MHz dual-channel DDR4 SDRAM SO-DIMMs (system max. 64 GB)	Two 204-pin 1600/1333 MHz dual-channel DDR3L SDRAM SO-DIMMs (support up to 8 GB)	Two 204-pin 1066/1333 MHz dual-channel unbuffered DDR3L SDRAM SO-DIMM support up to 8 GB (J1900) One 204-pin 1066/1333 MHz dual-channel unbuffered DDR3L SDRAM SO-DIMM supports up to 4 GB (N2807)	Two 204-pin 1600/1333 MHz dual-channel DDR3 & DDR3L SDRAM unbuffered DIMMs (system max. 16 GB)	Two 204-pin 1066/1333 MHz dual-channel unbuffered DDR3L SDRAM SO-DIMM support up to 8 GB (J1900, N2930, E3845, E3827, E3826) One 204-pin 1066/1333 MHz dual-channel unbuffered DDR3L SDRAM SO-DIMM supports up to 4 GB (N2807, E3825, E3815)
Display Interface	Triple independent display supported 1 x HDMI 2.0 2 x HDMI 1.4 1 x LVDS	Triple independent display supported 1 x HDMI 2.0 1 x HDMI/DP 1 x VGA 1 x iDP interface	Triple independent display supported 1 x HDMI/DP 1 x VGA 1 x 18/24-bit dual-channel LVDS	Dual independent display supported 1 x VGA 1 x DVI-I	Dual display supported 1 x VGA 1 x DVI-I 1 x iDP interface	Dual display supported 1 x VGA 2 x 18/24-bit dual-channel LVDS
Ethernet	LAN1: Intel® I219-LM with Intel® AMT 11.0 support LAN2: Intel® I211 PCIe controller	LAN1: Intel® I211 PCIe controller LAN2: Intel® I219LM with Intel AMT 11.0 support	Dual LAN: Realtek RTL8111G PCIe controller	Dual LAN: Realtek RTL8111HN PCIe controller	Dual LAN: Intel® I211-AT PCIe controller	Dual LAN: Realtek RTL8111E PCIe controller
I/O Interface	4 x USB 3.2 Gen 1 Type A 1 x RS-232 1 x KB/MS pin header 2 x RS-232/422/485 pin header 3 x RS-232 pin header 4 x USB 2.0 pin header	1 x KB/MS 4 x USB 3.2 Gen 1 Type A 2 x USB 2.0 2 x RS-232/422/485 pin header 4 x RS-232 pin header 4 x USB 2.0 pin header	4 x USB 3.2 Gen 1 Type A 1 x KB/MS pin header 2 x RS-232/422/485 pin header 4 x RS-232 pin header 2 x USB 2.0 pin header	2 x RS-232 2 x USB 2.0 2 x USB 3.2 Gen 1 Type A 1 x KB/MS pin header 1 x RS-422/485 pin header 3 x RS-232 pin header 4 x USB 2.0 pin header	2 x USB 2.0 2 x USB 3.2 Gen 1 Type A 2 x RS-232 1 x KB/MS pin header 1 x RS-422/485 pin header 3 x RS-232 pin header 4 x USB 2.0 pin header	2 x USB 2.0 2 x USB 3.2 Gen 1 Type A 2 x RS-232 1 x KB/MS pin header 1 x RS-422/485 pin header 1 x RS-232 pin header 2 x USB 2.0 pin header
Storage Interface	4 x SATA 6Gb/s (RAID 0/1/5/10 supported)	4 x SATA 6Gb/s (RAID 0/1/5/10 supported)	2 x SATA 6Gb/s 1 x mSATA 1 x microSD slot	2 x SATA 3Gb/s 1 x microSD slot (E38xx sku only)	2 x SATA 6Gb/s	2 x SATA 3Gb/s 1 x microSD card 1 x CFast slot
Audio	Realtek ALC888S HD Audio codec					
Digital I/O	8-bit digital I/O			8-bit digital I/O	8-bit programmable digital I/O	
Power Consumption	12V@5.08A (Intel® Core™ i7-6820EQ, 3.5GHz CPU with 16 GB (two 8 GB) 2133 MHz DDR4 memory)	3.3V@1.62A, 5V@3.54A, 12V@8.17A, 5VSB@3.6A (Intel® Core™ i7 6700K 4.0 GHz CPU with 16 GB (two 8 GB) 2133 MHz DDR4 memory)	12V@1.61A (Intel® Celeron® N3710 CPU with two 4 GB 1600 MHz DDR3L memory)	12V@1.64A (Intel® Celeron® J1900 CPU with 4 GB 1333 MHz DDR3L memory)	12V@6.03A (Intel® Core™ i7-4770K 3.90 GHz CPU with two 1333 MHz 4 GB DDR3 memory)	12V@1.55A (Intel® Celeron® J1900 CPU with two 8 GB 1333 MHz DDR3L memory)
Watchdog Timer	Software programmable and supports 1~255 sec. system reset					
Operation Environment	Temperature Range: -20°C ~ 60°C (-4°F ~ 140°F) Relative Humidity: 5% ~ 95%, non-condensing					Temperature Range: 0°C ~ 60°C (32°F ~ 140°F) Relative Humidity: 5% ~ 95% non-condensing
Expansion Slot	1 x PCIe x16 1 x Full-size PCIe Mini card 1 x Half-size PCIe Mini card 1 x M.2 2230 (A key)	1 x PCIe x8 1 x Full-size PCIe Mini card	1 x PCIe x1 1 x PCIe Mini card	1 x Full-size PCIe Mini card slot (support mSATA) 1 x PCIe x4 slot (with PCIe x1 signal)	1 x Full-size PCIe Mini card slot 1 x PCIe x1 slot	1 x Full-size PCIe Mini card slot 1 x PCIe x1 slot
CPU Cooler	Heatsink	CF-1156C-R20 CF-1156D-R30 CF-115XE-R10	Heatsink	Heatsink	CF-115XA-R10 CF-115XE-R10	Heatsink

KINO-ADL-P

Mini-ITX SBC with 12th Gen. Intel® Alder Lake-P on-board processor, DDR4 SO-DIMM, 12~28V DC input, quad display, SATA, triple Intel® 2.5GbE, USB 3.2, M.2, SoC, RoHS

preliminary

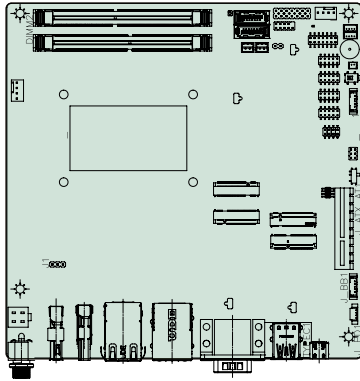

Dimensions (Unit: mm)

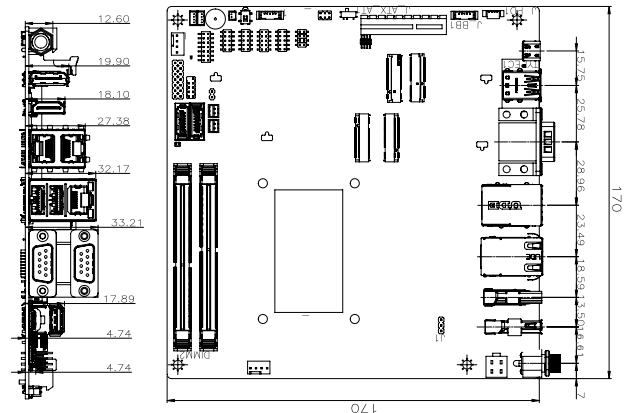

Specifications

- ◆ CPU
12th Gen. Intel® mobile Alder Lake-P on-board processor
- ◆ BIOS
AMI UEFI BIOS
- ◆ Memory
2 x 260-pin 3200 MHz DDR4 SO-DIMM (system max. 64GB)
- ◆ Graphics Engine
Intel® Xe Graphics architecture, 4 independent displays, up to 8K resolution
- ◆ Display Output
Quadruple independent display
1 x HDMI 1.4 (up to 4096 x 2160@30Hz)
1 x DP 1.4 (up to 4096 x 2160 @60Hz)
2 x Type-C DP (up to 4096 x 2304 @60Hz) with Thunderbolt
1 x IEI IDPM 3040 slot (only for IEI eDP/ LVDS/ VGA module)
- ◆ Ethernet
LAN1: Intel® I225V 2.5GbE controller
LAN2: Intel® I225V 2.5GbE controller
LAN3: Intel® I225V 2.5GbE controller
- ◆ External I/O Interface
3 x USB 3.2 Gen 2 (10Gb/s)
2 x RS-232/422/485
2 x USB4
- ◆ Internal I/O Interface
2 x SATA 6Gb/s
4 x USB 2.0 (2x4pin, P=2.0)
4 x RS-232 (2x5 pin, P=2.0)
- ◆ SMBus
1 x SMBus (1x4 pin)
- ◆ I²C
1 x I²C (1x4 pin)
- ◆ Audio
1 x IAUDIO, support IEI AC-KIT-888S Audio Module (2x5 pin)
- ◆ Front Panel
1 x Front Panel (2x7pin, Power LED, HDD LED, Speaker, Power Button, Reset Button)
- ◆ Expansion
1 x PCIe x4 slot, open-ended
1 x M.2 A key for Wi-Fi & BT 2230 (PCIe x1 & USB 2.0)
1 x M.2 B key 3042 (PCIe x1 + USB 3.2 / USB 2.0)
1 x M.2 M key 2280 (PCIe x4)
- ◆ Digital I/O
1 x 12-bit digital I/O (2x7 pin)
- ◆ TPM
Intel® PTT (TPM 2.0)
- ◆ Fan Connector
1 x CPU fan connector (1x4 pin)
1 x System fan connector (1x4 pin)
- ◆ Power Supply
Input voltage: 12~28V
1 x Internal power connector (2x2 pin)
1 x External DC power jack (Ø5.5mm)
ErP/EuP Compliant
- ◆ Watchdog Timer
Software Programmable support 1~255 sec. System reset
- ◆ Power Consumption
TBD
- ◆ Operating Temperature
0°C ~ 60°C
- ◆ Storage Temperature
-30°C ~ 70°C
- ◆ Operating Humidity
5% ~95%, non-condensing
- ◆ Dimensions
170 mm x 170 mm
- ◆ Weight
GW:900g / NW:450g
- ◆ Certification
CE/FCC Compliant

Packing List

1 x KINO-ADL-P single board computer	2 x SATA cable
1 x I/O shielding	1 x QIG

Ordering Information

Part No.	Description
KINO-ADL-P-C-R10	Mini-ITX SBC with Intel® Alder Lake-P Celeron® processor, DDR4 SO-DIMM, 12~28V DC input, quad display, SATA, triple Intel® 2.5GbE, USB 3.2, M.2, SoC, RoHS
KINO-ADL-P-i3-R10	Mini-ITX SBC with Intel® Alder Lake-P Core™ i3 processor, DDR4 SO-DIMM, 12~28V DC input, quad display, SATA, triple Intel® 2.5GbE, USB 3.2, M.2, SoC, RoHS
KINO-ADL-P-i5-R10	Mini-ITX SBC with Intel® Alder Lake-P Core™ i5 processor, DDR4 SO-DIMM, 12~28V DC input, quad display, SATA, triple Intel® 2.5GbE, USB 3.2, M.2, SoC, RoHS
KINO-ADL-P-i7-R10	Mini-ITX SBC with Intel® Alder Lake-P Core™ i7 processor, DDR4 SO-DIMM, 12~28V DC input, quad display, SATA, triple Intel® 2.5GbE, USB 3.2, M.2, SoC, RoHS

Optional Accessories

Part No.	Description
CB-USB02A-RS	Dual port USB cable with bracket, 300mm, P=2.00
AC-KIT-888S-R10	Realtek ALC888S 7.1 Channel HD Audio peripheral board, RoHS
32102-000100-200-RS	SATA power cable, MOLEX 5264-4P to SATA15P
32205-000702-200-RS	RS-232 cable, 230mm, P=2.54

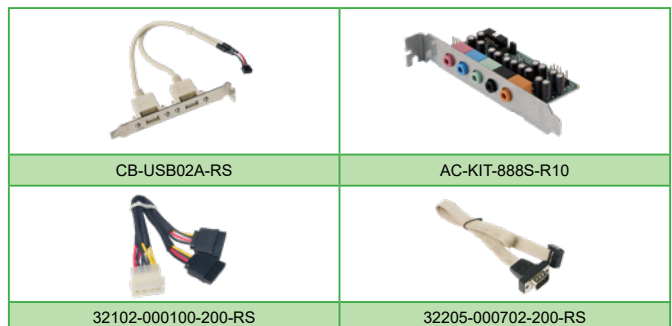

KINO-EHL-J6412



Mini-ITX SBC supports Intel® Elkhart Lake Celeron® on-board SoC with Triple Independent Display, HDMI, DP, IDPM, SATA 6Gb/s, Dual 2.5GbE, USB 3.2, M.2, 12V DC input and RoHS

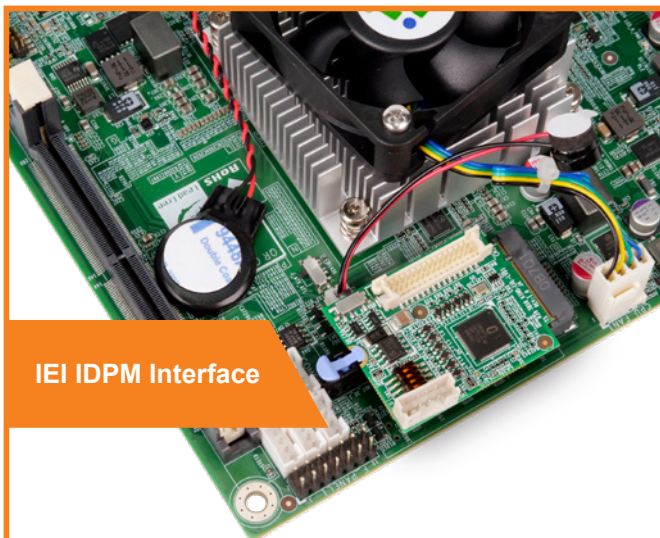
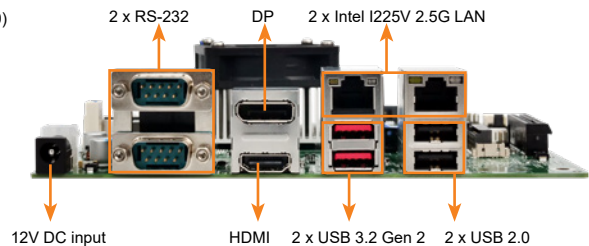
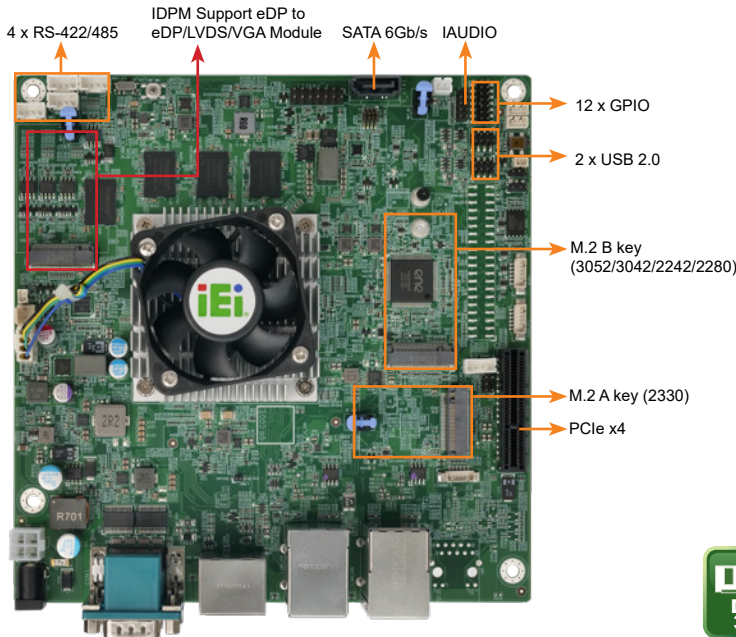

IEI IDPM Interface

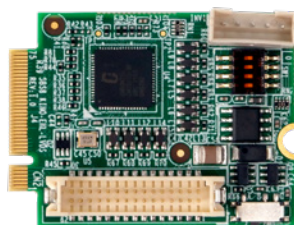

IDPM-LVDS

eDP to 24-bit dual-channel LVDS converter board

Features



10W Low-power Intel® Elkhart Lake Celeron® J6412 CPU

Intel® 10nm Celeron® J6412 On-board SoC, 4 cores and 4 threads, base frequency 2.00GHz, turbo frequency up to 2.60GHz, 1.5MB cache



Supporting Intel® I225V 2.5GbE Controllers

Two RJ45 network interfaces are supported via Intel® I225V 2.5GbE controllers, achieving up to 2.5GbE network transmission rate.



Rich Expansion I/O

Support one M.2 A key for Wi-Fi & Bluetooth modules, one M.2 B key 3042 for 5G modules and one open-ended PCIe Gen3 x4 slot.



IEI-specific IDPM Interface

IEI uniquely designs a IDPM interface that can connect to display modules, enabling users to add LVDS/eDP/VGA display interface upon requirements.

Specifications

- ◆ CPU
 - Intel® Elkhart Lake Processor
 - Intel® Celeron® J6412 on-board SoC (up to 2.6GHz, quad-core, 1.5M Cache, TDP=10W)
- ◆ BIOS
 - AMI UEFI BIOS
 - Dual BIOS for boot & recovery
- ◆ Memory
 - Onboard LPDDR4x-3200MHz 4GB, system up to 8GB
- ◆ Graphics Engine
 - Gen11LP Gfx firmware and driver, Media SDK, OpenCL* 1.2, OpenGL 4.5, OpenGL-ES 3.2, Vulkan v1.1, DirectX
- ◆ Display Output
 - Triple Independent Display
 - 1 x HDMI 1.4 (up to 4096 x 2160@30Hz)
 - 1 x DP 1.4 (up to 4096 x 2160 @60Hz)
 - 1 x IEI IDPM 3040 slot (only for IEI eDP/LVDS/VGA module)
- ◆ Ethernet
 - LAN1: Intel® I225V 2.5GbE controller
 - LAN2: Intel® I225V 2.5GbE controller
- ◆ External I/O Interface
 - 2 x USB 3.2 Gen 2 (10Gb/s) (USB Type A)
 - 2 x USB 2.0 (USB Type A)
 - 2 x RS-232
- ◆ Internal I/O Interface
 - 1 x SATA 6Gb/s
 - 4 x USB 2.0 (2x4 pin, P=2.0)
 - 4 X RS-422/485 (pin header)
- ◆ SMBus
 - 1 x SMBus (1x4 pin)
- ◆ I²C
 - 1 x I²C (1x4 pin)
- ◆ Audio
 - 1 x IAUDIO, support IEI AC-KIT-888S Audio Module (2x5 pin, P=2.0)
- ◆ Front Panel
 - 1 x Front Panel (2x7 pin, power LED, HDD LED, power button, reset button)
- ◆ LAN LED
 - 2 x LAN LED (1x2 pin)
- ◆ Expansion
 - 1 x PCIe x4 slot, open-ended (PCIe Gen3 x1 signal)
 - 1 x M.2 A key (2230) (PCIe x1 & USB 2.0)
 - 1 x M.2 B key (3052/3042/2242/2280) w/ SIM holder (PCIe x2 USB 2.0)
- ◆ Digital I/O
 - 1 x 12-bit DIO (2x7 pin)
- ◆ TPM
 - Intel® PTT(TPM 2.0)
- ◆ Fan Connector
 - 1 x CPU fan connector (1x4 pin)
 - 1 x System fan connector (1x3 pin)
- ◆ Power Supply
 - 12V DC input
 - 1 x Internal power connector (2x2 pin)
 - 1 x External DC power jack (Ø5.5mm)
 - ErP/EuP Compliant
- ◆ Watchdog Timer
 - Software programmable, support 1~255 sec. system reset
- ◆ Power Consumption
 - TBD
- ◆ Operating Temperature
 - 0°C ~ 60°C
- ◆ Storage Temperature
 - 30°C ~ 70°C
- ◆ Operating Humidity
 - 5% ~95%, non-condensing
- ◆ Dimension
 - 170 mm x 170 mm
- ◆ Weight
 - GW:900g / NW:400g
- ◆ Certification
 - CE/FCC Compliant

Dimensions (Unit: mm)

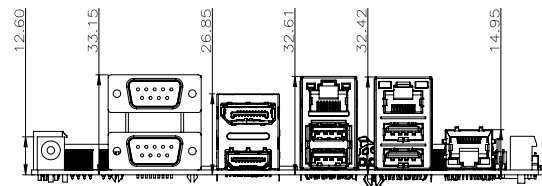
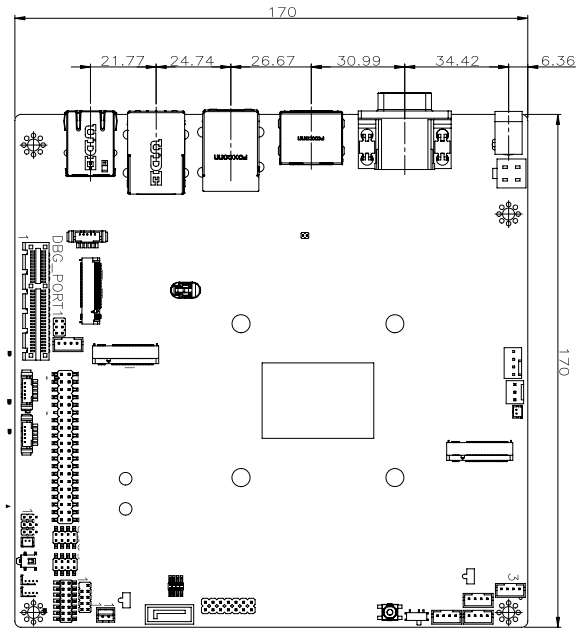

Packing List

1 x KINO-EHL single board computer with cooler module	2 x SATA cable
1 x I/O shielding	1 x QIG

Ordering Information

Part No.	Description
KINO-EHL-J6412-R10	Mini-ITX SBC supports Intel® Elkhart Lake Celeron® J6412 onboard SoC with triple independent display, HDMI, DP, IDPM, SATA 6Gb/s, dual 2.5GbE, USB 3.2, M.2, 12V DC input and RoHS

Optional Accessories

Part No.	Description
CB-USB02A-RS	Dual port USB cable with bracket, 300mm, P=2.00
AC-KIT-888S-R10	Realtek ALC888S 7.1 Channel HD Audio peripheral board, RoHS
32102-000100-200-RS	SATA power cable, MOLEX 5264-4P to SATA15P
32205-000702-200-RS	RS-232 cable, 230mm, P=2.54

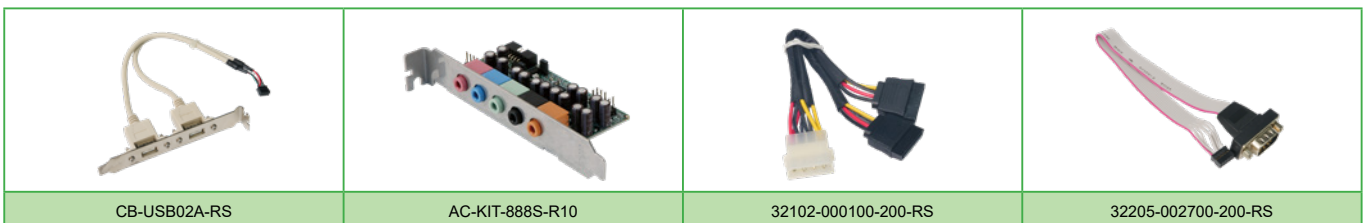

KINO-TGL-U



Mini-ITX SBC supports Intel® Tiger Lake-UP3 Processor, 12~28V DC input, triple independent displays, HDMI, DP, SATA 6Gb/s, dual Intel® 2.5GbE, USB 3.2, M.2 and RoHS

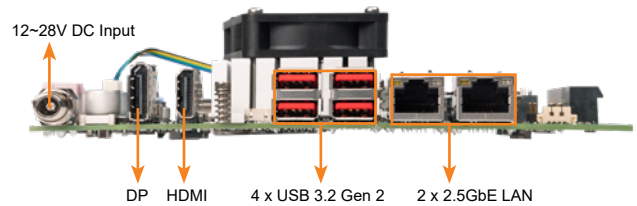
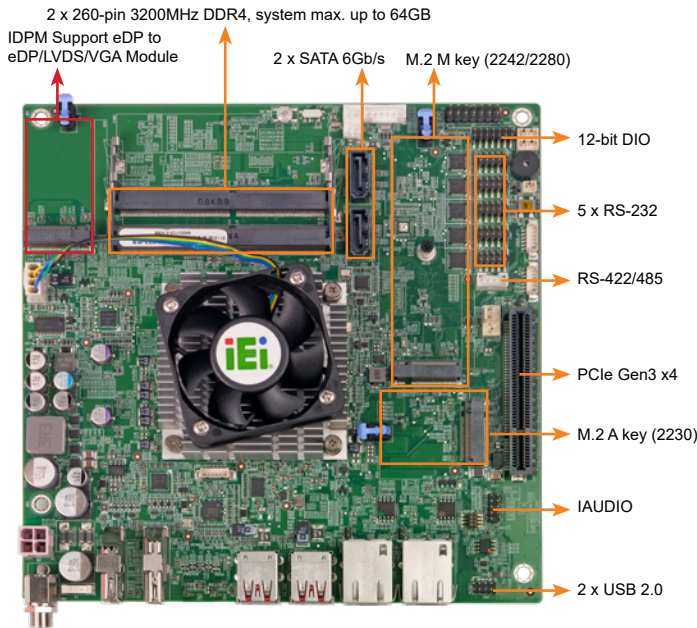

IDPM-LVDS

eDP to 24-bit dual-channel LVDS converter board

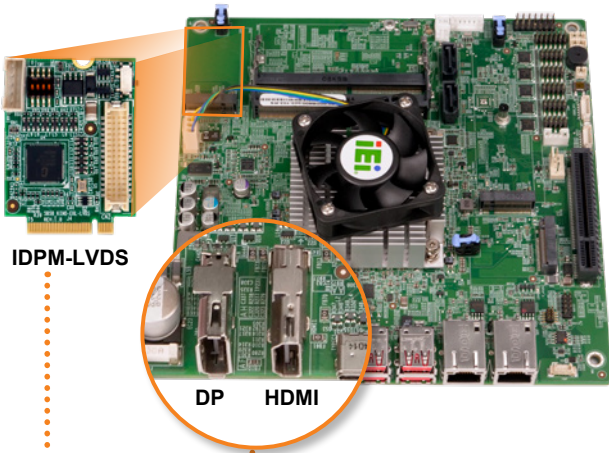

Triple Independent Displays



Features



Support Intel® Tiger Lake-UP3 Processors

Equipped with 11th Gen. Intel® Core™ i7/i5/i3, Celeron® UP3 processor, the KINO-TGL features high performance, and can handle multitasking efficiently.



Support Intel® I225V 2.5GbE Network Controller

Two Gigabit RJ45 network ports are provided via Intel® I225V 2.5GbE network controller to achieve up to 2.5GbE network transmission rate.



Abundant Expansion Slots

The KINO-TGL provides PCIe x8 for expansion, M.2 A key for Bluetooth and Wi-Fi modules, M.2 M key for NVME storage, and M.2 B key for 5G modules and storage.



IEI-specific IDPM Interface

IEI uniquely designs a IDPM interface that can connect to display modules, enabling users to add LVDS/eDP/VGA display interface upon requirements.

Specifications

- ◆ CPU
 - 11th Gen. Intel® mobile Tiger Lake-UP3 SoC
 - Intel® Core™ i7-1185G7E (up to 4.8GHz, quad-core, 12M Cache, TDP=28/15/12W)
 - Intel® Core™ i5-1145G7E (up to 4.4GHz, quad-core, 8M Cache, TDP=28/15/12W)
 - Intel® Core™ i3-1115G4E (up to 4.1GHz, quad-core, 6M Cache, TDP=28/15/12W)
 - Intel® Celeron® 6305 (up to 1.8GHz, dual-core, 4M Cache, TDP=15W)
- ◆ BIOS
 - AMI UEFI BIOS
- ◆ Memory
 - 2 x 260-pin 3200MHz DDR4, system max. up to 64GB
- ◆ Graphics Engine
 - Intel® HD Graphics Gen 12 Gfx; Up to 96EU; 2VDbox; AI (INT8)
 - HDMI 2.0 integrated, 4 Display Pipes, 8k60/210b
 - AV1 Codec, 12b support, E2E Compression, IPU6 FF
- ◆ Display Output
 - Triple independent display
 - 1 x HDMI 1.4 (up to 4096 x 2160@30Hz)
 - 1 x DP 1.4 (up to 4096 x 2160 @60Hz)
 - 1 x IEI IDPM 3040 slot (only for IEI eDP/LVDS/VGA module)
- ◆ Ethernet
 - LAN1: Intel® I225V 2.5GbE controller
 - LAN2: Intel® I225V 2.5GbE controller
- ◆ External I/O Interface
 - 4 x USB 3.2 Gen 2 (10Gb/s)
- ◆ Internal I/O Interface
 - 2 x SATA 6Gb/s with 5V SATA power connector
 - 1 x RS-422/485 (1x4 pin, P=2.0) (RS-485 support AFC)
 - 2 x USB 2.0 (2x4 pin, P=2.0)
 - 5 x RS-232 (2x5 pin, P=2.0)
- ◆ SMBus
 - 1 x SMBus (1x4 pin)
- ◆ I²C
 - 1 x I²C (1x4 pin)
- ◆ Audio
 - 1 x IAUDIO, support IEI AC-KIT-888S Audio Module (2x5 pin)
- ◆ Front Panel
 - 1 x Front Panel (2x7 pin, power LED, HDD LED, power button, reset button)
- ◆ LAN LED
 - 2 x LAN LED (1x2 pin)
- ◆ Expansion
 - 1 x PCIe x4 slot, open-ended (PCIe Gen3 x4 signal)
 - 1 x M.2 A key (2230) (PCIe Gen3 x1 & USB 2.0 signal)
 - 1 x M.2 M key (2242/2280) (PCIe Gen3 x2 signal)
- ◆ Digital I/O
 - 1 x 12-bit digital I/O (2x7 pin, P=2.0)
- ◆ TPM
 - Support Intel® PTT (TPM 2.0)
- ◆ Fan Connector
 - 1 x CPU fan connector (1x4 pin)
 - 1 x System fan connector (1x4 pin)
- ◆ Power Supply
 - 10~28V DC input
 - 1 x Internal power connector (2x2 pin)
 - 1 x External DC power jack (Ø5.5mm)
 - ErP/EuP Compliant
- ◆ Watchdog Timer
 - Software programmable, support 1~255 sec. system reset
- ◆ Power Consumption
 - TBD
- ◆ Operating Temperature
 - 0°C ~ 60°C
- ◆ Storage Temperature
 - 30°C ~ 70°C
- ◆ Operating Humidity
 - 5% ~95%, non-condensing
- ◆ Dimension
 - 170 mm x 170 mm
- ◆ Weight
 - GW:900g / NW:400g
- ◆ Certification
 - CE/FCC Compliant

Dimensions (Unit: mm)

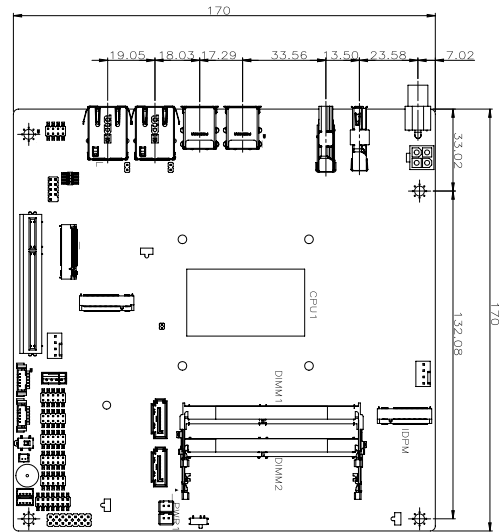

Packing List

1 x KINO-TGL-U single board computer with Cooler Module	1 x SATA cable
1 x Power cable for P4	1 x QIG

Ordering Information

Part No.	Description
KINO-TGL-U-C-R10	Mini-ITX SBC with Intel® Tiger Lake-UP3 Celeron® 6305 Processor,DDR4 SO-DIMM, 10~28V DC input, Quad Display,SATA,Dual Intel® 2.5GbE,USB3.2,M.2,SoC,RoHS
KINO-TGL-U-i3-R10	Mini-ITX SBC with Intel® Tiger Lake-UP3 Core™ i3-1115G4E Processor, DDR4 SO-DIMM, 10~28V DC input, quad display, SATA, dual Intel® 2.5GbE, USB 3.2, M.2, SoC, RoHS
KINO-TGL-U-i5-R10	Mini-ITX SBC with Intel® Tiger Lake-UP3 Core™ i5-1145G7E Processor, DDR4 SO-DIMM, 10~28V DC input, quad display, SATA, dual Intel® 2.5GbE, USB 3.2, M.2, SoC, RoHS
KINO-TGL-U-i7-R10	Mini-ITX SBC with Intel® Tiger Lake-UP3 Core™ i7-1185G7E Processor, DDR4 SO-DIMM, 10~28V DC input, quad display, SATA, dual Intel® 2.5GbE, USB 3.2, M.2, SoC, RoHS

Optional Accessories

Part No.	Description
CB-USB02A-RS	Dual port USB cable with bracket, 300mm, P=2.00
AC-KIT-888S-R10	Realtek ALC888S 7.1 Channel HD Audio peripheral board, RoHS
32102-000100-200-RS	SATA power cable, MOLEX 5264-4P to SATA15P
32205-002700-200-RS	RS-232/422/485, 200mm, P=2.0

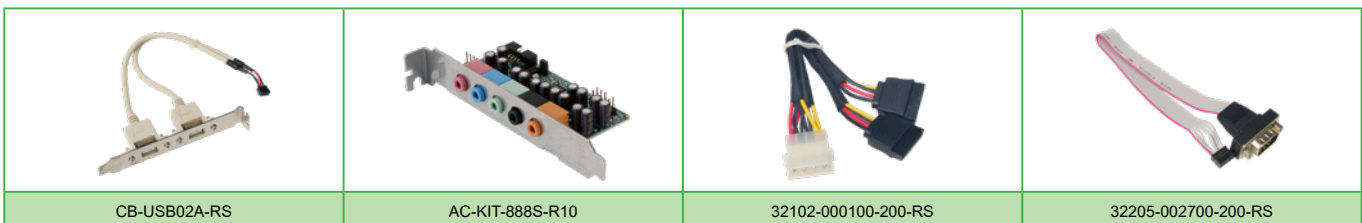

KINO-DH420



Mini-ITX SBC supports LGA1200 10th Generation Intel® Core™ i9/i7/i5/i3, Pentium® and Celeron® CPU per Intel® H420E, DDR4, dual independent display, triple GbE LAN, M.2, SATA 6Gb/s, HD Audio and RoHS

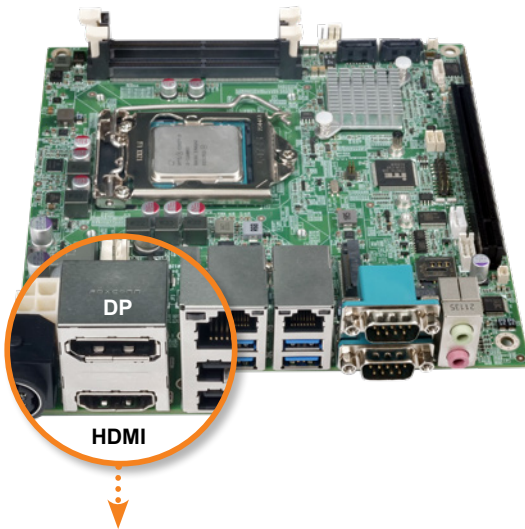
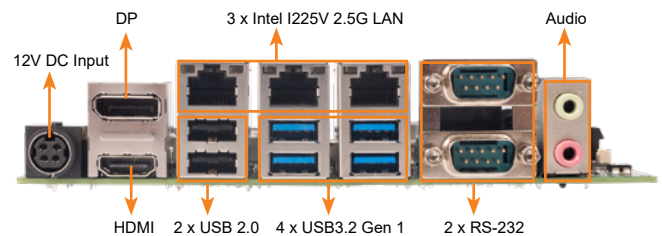
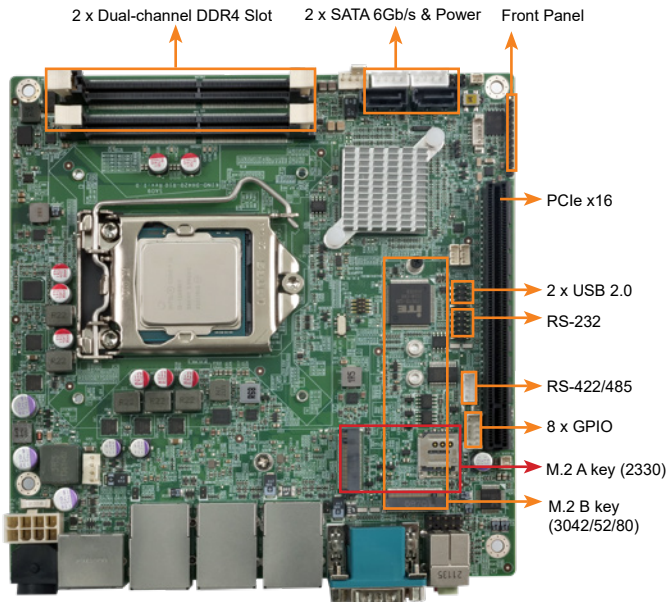

Dual Independent Display



Features



Support 10th Gen Intel® Processors

Equipped with 10th Gen. Intel® Core™ i9/i7/i5/i3, Celeron® and Pentium® processors, the KINO-DH420 features superior performance, and can handle multitasking efficiently.



Support Intel® I225V 2.5GbE Controller

Support triple RJ45 network interfaces based on Intel® I225V/I225LM 2.5GbE network controller to achieve up to 2.5GbE network transmission rate.



Support Multiple Expansion Slots

Support one PCIe Gen3 x16 slot that can enable PCIe function expansion, M.2 A key that can be used for Wi-Fi modules or Bluetooth modules, and M.2 B key with SIM card that can be used for 5G module and NVME storage expansion.



Support Dual Independent Display

Support dual independent display outputs: one DP (resolution up to 4096 x 2304 @60Hz) and one HDMI (resolution up to 4096 x 2160@30Hz).

Specifications

- ◆ CPU
LGA1200 socket supports 10th Generation Core™ i9/i7/i5/i3, Celeron® and Pentium® processor
- ◆ Chipset
Intel® H420E
- ◆ BIOS
AMI UEFI BIOS
- ◆ Memory
Two 260-pin 2933 MHz dual-channel DDR4 SO-DIMMs (system max. 64GB)
- ◆ Graphics Engine
Intel® HD Graphics Gen9 Engines with 16 low-power execution units, supporting DX11.3/12, OpenGL 4.3/4.4/4.5 and OpenCL 1.2/2.0/2.1
- ◆ Display Output
Dual independent display
1 x DP (up to 4096 x 2304 @60Hz)
1 x HDMI (up to 4096 x 2160@30Hz)
- ◆ Ethernet
LAN1: Intel® I225V 2.5GbE controller
LAN2: Intel® I225V 2.5GbE controller
LAN3: Intel® I225V 2.5GbE controller
- ◆ External I/O Interface
2 x RS-232
2 x USB 2.0
4 x USB 3.2 Gen 1 (5Gb/s)
- ◆ Internal I/O Interface
1 x RS-232 (2 x 5 pin, P=2.0)
1 x RS-422/485 (1 x 4 pin, P=2.0)
2 x SATA 6Gb/s (No RAID)
2 x USB 2.0 (2 x 4 pin, P=2.0)
- ◆ I²C
1 x I²C (1x4 pin)
- ◆ SMBus
1 x SMBus (1x4 pin)
- ◆ Audio
Realtek ALC888S HD codec
2 x Audio Jack (Lin-out, Mic-in)
1 x Front audio (2x5 pin P=2.54)
- ◆ Front Panel
1 x Front Panel (1x10 pin, Power LED, HDD LED, Power Button, Reset Button)
- ◆ LAN LED
3 x LAN LED (1x2 pin)
- ◆ Expansion
1 x PCIe Gen3 x16
1 x M.2 A key (2230) (PCIe Gen 3 x1/USB 2.0)
1 x M.2 B key (3042/3052/2242/2280) w/ SIM holder (PCIe Gen 3 x2 /USB 2.0)
- ◆ Digital I/O
1 x 8-bit digital I/O connector (2x5 pin)
- ◆ TPM
Intel® PTT (TPM 2.0)
- ◆ Fan Connector
1 x CPU fan connector (1x4 pin)
1 x System fan connector (1x4 pin)
- ◆ Power Supply
DC 12V input
1 x ATX power connector (2x4 pin)
1 x DIN 4-pin DC Jack
Support AT/ATX mode
ErP/EuP Compliant
- ◆ Watchdog Timer
Software Programmable support 1~255 sec. System reset
- ◆ Power Consumption
12V@12.408A (Intel Core i7-10900E CPU with two 32 GB 2933 MHz DDR4 memory, EuP/ErP mode disabled)
- ◆ Operating Temperature
0°C ~ 60°C
- ◆ Storage Temperature
-30°C ~ 70°C
- ◆ Operating Humidity
5% ~95%, non-condensing
- ◆ Dimensions
170mm x 170mm
- ◆ Weight
GW:900g / NW:400g

Dimensions (Unit: mm)

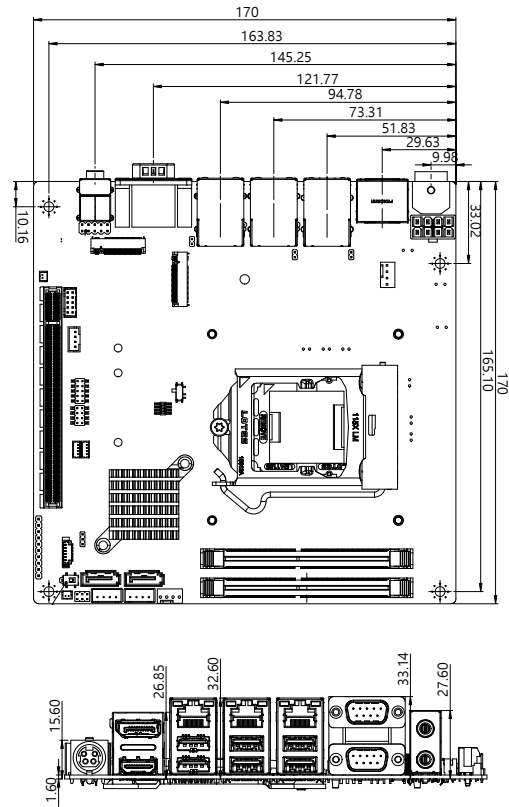

Packing List

1 x KINO-DH420 single board computer	1 x SATA cable
1 x I/O Shielding	1 x QIG

Ordering Information

Part No.	Description
KINO-DH420-R10	Mini-ITX SBC supports LGA1200 10th Generation Intel® Core™ i9/i7/i5/i3/ Pentium®/Celeron® CPU per Intel® H420E, DDR4, dual independent displays, triple GbE LAN, M.2, SATA 6Gb/s, HD Audio and RoHS

Optional Accessories

Part No.	Description
19800-000300-100-RS	RS-232 cable with bracket, 300mm, P=2.0
32205-003800-300-RS	RS-422/485 cable, 200mm, P=2.0
32801-000703-500-RS	SATA cable, 500mm
CF-115XA-R10	LGA1155/1156 cooler kit, 1U chassis compatible, 73W
CF-1156C-R20	LGA1155/LGA1156 cooler kit, 1U chassis compatible, 45W
CF-1156D-R30	LGA1155/LGA1156 cooler kit, 1U chassis compatible, 65W
CF-115XE-R10	High-performance LGA1155/1156 cooler kit, 95W



KINO-KX-U6580-U6780A

Mini-ITX SBC supports Zhaoxin 16nm KX-U6580/KX-U6780A(70W) on-board processor with PCIe Mini, VGA, DVI, USB 3.2 Gen1, SATA 6Gb/s, COM, Audio and RoHS

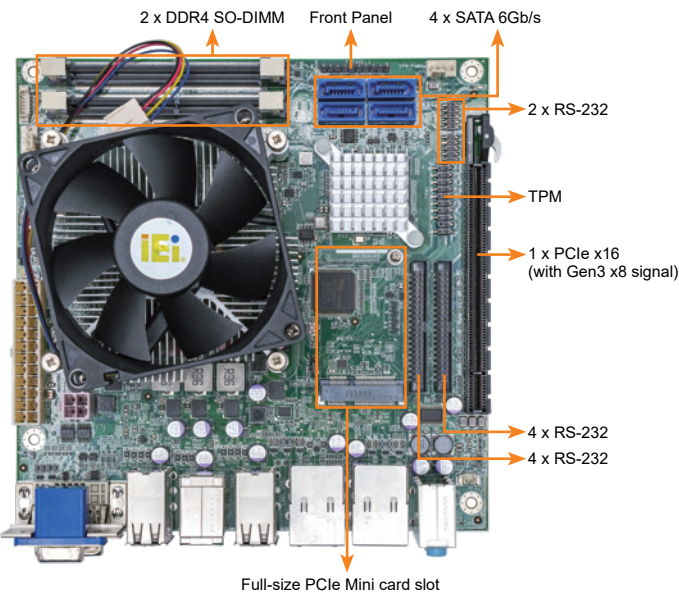

Rich I/O

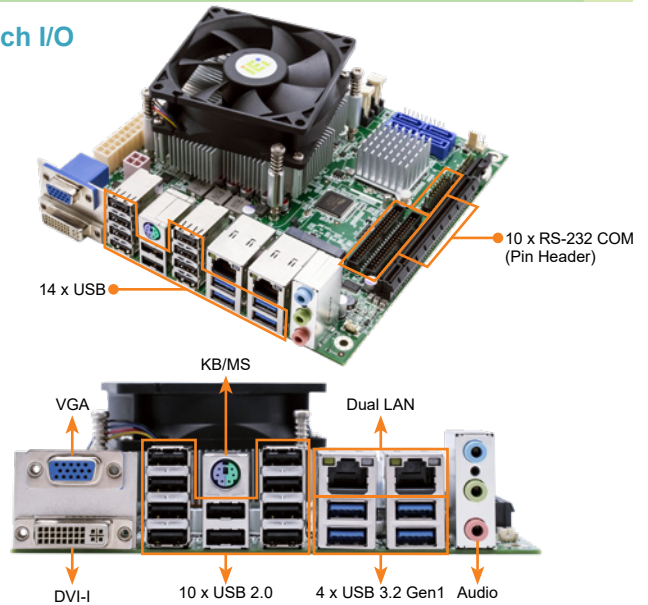

Specifications

- ◆ SoC
Zhaoxin Kaixian KX-6000 series 8-core processor
Zhaoxin KX-U6580 on-board SoC (8-Core, 8MB Cache, 2.5GHz, 70W)
Zhaoxin KX-U6780A on-board SoC (8-Core, 8MB Cache, 2.7GHz, 70W)
- ◆ Chipset
Zhaoxin ZX-200
- ◆ BIOS
AMI UEFI BIOS
- ◆ Memory
2 x 260-pin 2666MHz Dual-channel DDR4 SO-DIMM (system max. 64GB)
- ◆ Graphics Engine
C-960 Graphics Processing Unit with 2D/3D/Video Acceleration
- ◆ Display Output
1 x VGA (up to 1920x1080@60Hz)
1 x DVI-I (up to 1920x1080@60Hz)
- ◆ Ethernet
LAN1: Realtek RTL8111H PCIe GbE controller
LAN2: Realtek RTL8111H PCIe GbE controller
- ◆ External I/O Interface
10 x USB 2.0
4 x USB 3.2 Gen 1 (5Gb/s)
1 x KB/MS
- ◆ Internal I/O Interface
2 x RS-232 (2x5 pin, P=2.0)
8 x RS-232 (2x20 pin, P=2.0)
4 x SATA 6Gb/s
- ◆ TPM
TPM: 1 x TPM 2.0 connector (2x10 pin) (LPC interface)
- ◆ Audio
Realtek ALC888S
3 x Audio jacks (line-out, line-in, mic-in) on rear IO
- ◆ Front Panel
1 x Front panel (1x10 pin, power LED, HDD LED, power button, reset button)
- ◆ Expansion
1 x Full-size PCIe Mini card slot
1 x PCIe x16 slot (with PCIe Gen3 x8 signal)
- ◆ Fan Connector
1 x CPU smart fan connector (1x4 pin)
1 x System smart fan connector (1x4 pin)
- ◆ Power Supply
ATX power supply
- ◆ Watchdog Timer
Software Programmable support 1~255 sec. System reset
- ◆ Power Consumption
12V @ 3.38A, 3.3V @ 0.62A, 5V @ 9.81A, 5VSB @ 0.03A
(Zhaoxin KX-U6580 2.5 GHz CPU with 8 GB 2400 MHz DDR4 memory)
- ◆ Operating Temperature
-10°C ~ 60°C
- ◆ Storage Temperature
-20°C ~ 60°C
- ◆ Operating Humidity
20% ~ 95%, non-condensing
- ◆ Dimensions
170 mm x 170 mm
- ◆ Weight
GW:900g / NW:400g
- ◆ CE/FCC compliant



Features

- Mini-ITX SBC supports Zhaoxin 16nm KX-U6580/KX-U6780A(70W) on-board processor supports dual-channel DDR4 SO-DIMMs
- Dual independent display(VGA & DVI-I) support
- Up to 10 x RS-232 and 10 x USB 2.0 support
- USB 3.2 Gen1, SATA 6Gb/s, Full-size PCIe Mini Card slot and PCIe x16 expansion slot
- ATX power input

Dimensions (Unit: mm)

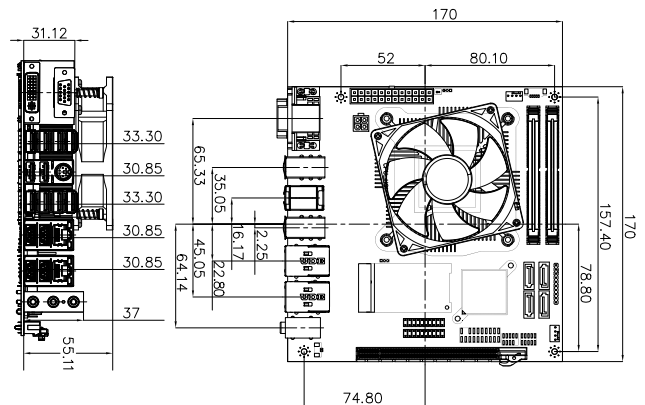

Packing List

1 x KINO-KX single board computer with CPU Cooler	1 x I/O Shielding
1 x SATA cable	1 x QIG

Ordering Information

Part No.	Description
KINO-KX-U6580-R10	Mini-ITX SBC supports Zhaoxin 16nm KX-U6580 (70W) on-board processor with PCIe Mini, VGA, DVI, USB 3.2 Gen1, SATA6Gb/s, COM, Audio and RoHS
KINO-KX-U6780A-R10**	Mini-ITX SBC supports Zhaoxin 16nm KX-U6780A (70W) on-board processor with PCIe Mini, VGA, DVI, USB 3.2 Gen1, SATA 6Gb/s, COM, Audio and RoHS
32200-025401-RS	RS-232 cable, 300mm, P=2.0, 40-pin
32205-002000-100-RS	RS-232/422/485 cable, 300mm, P=2.0, 40-pin
32205-002700-200-RS	RS-232 cable, 200mm, P=2.0
TPM-IN02-R20	20-pin Infineon TPM 2.0 module, software management tool, firmware v5.5

** By order production, MOQ: 100

KINO-DH310

Mini-ITX SBC supports 14nm LGA1151 Intel® 8th/9th Generation Core™ i9/i7/i5/i3, Celeron® and Pentium® processor, DDR4, dual independent displays, dual GbE LAN, M.2, SATA 6Gb/s, HD Audio and RoHS

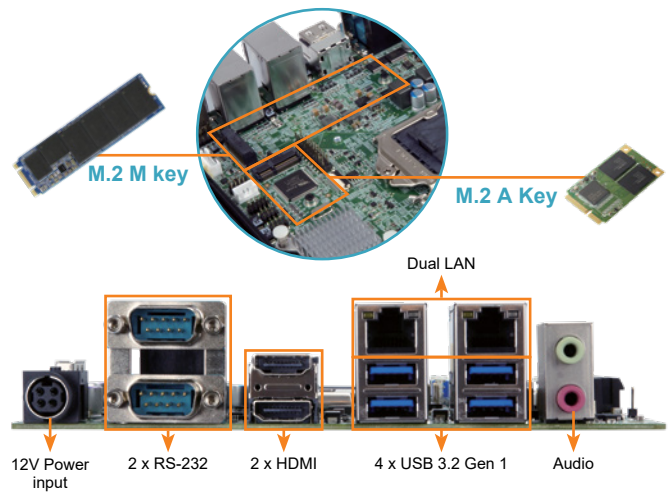
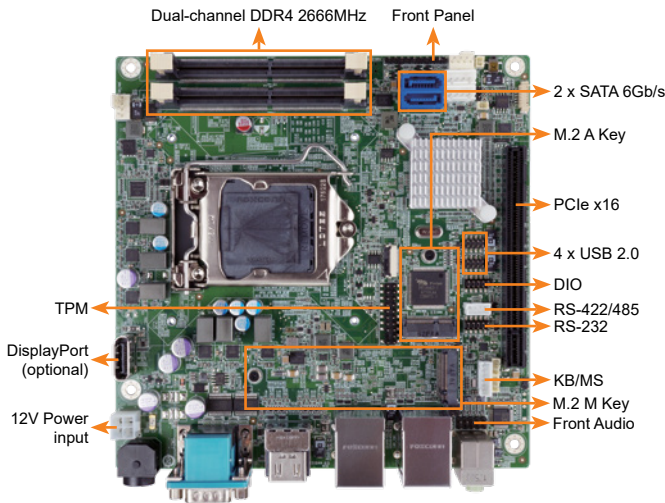

Specifications

- ◆ CPU: LGA1151 socket supports 8th/9th generation Intel® Core™ i9/i7/i5/i3, Pentium® or Celeron® processor (35W/65W)
- ◆ Chipset: Intel® H310
- ◆ BIOS: AMI UEFI BIOS
- ◆ Memory: Two 260-pin 2666/2400 MHz Dual-channel DDR4 SDRAM Unbuffered SO-DIMM slots supported up to 64GB
- ◆ Graphics Engine: Intel® HD Graphics Gen9 Engines with Low power 16 execution unit, supports DX11.3/12, OpenGL 4.3/4.4/4.5 and OpenCL 1.2/2.0/2.1
- ◆ Display Output: Dual independent display, 2 x HDMI (up to 4096x2160@30Hz), 1 x internal DisplayPort (up to 4096x2304@60Hz) (optional)
- ◆ Ethernet: LAN1: Realtek RTL8111H PCIe GbE controller, LAN2: Realtek RTL8111H PCIe GbE controller
- ◆ External I/O Interface: 4 x USB 3.2 Gen 1 (5Gb/s), 2 x RS-232
- ◆ Internal I/O Interface: 1 x KB/MS (1x6 pin), 4 x USB 2.0 (2x4 pin, P=2.0), 1 x RS-422/485 (1x4 pin, P=2.0), 1 x RS-232 (2x5 pin, P=2.0), 2 x SATA 6Gb/s with 5/12V SATA power connector (No RAID)
- ◆ I²C: 1 x I²C (1x4 pin)
- ◆ TPM: 1 x TPM (2x10 pin)
- ◆ SMBus: 1 x SMBus (1x4 pin)
- ◆ Audio: Realtek ALC888S HD Audio codec, 2 x Audio Jack (Lin-out, Mic-in), 1 x Front audio (2x5 pin)
- ◆ Front Panel: 1 x Front Panel (1x10 pin, Power LED, HDD LED, Power Button, Reset Button)
- ◆ LAN LED: 2 x LAN LED (1x2 pin)
- ◆ Expansion: 1 x PCIe x16, 1 x M.2 M key (2280, Gen2 PCIe x2 only), 1 x M.2 A Key (2230, PCIe x1 & USB 2.0)
- ◆ Digital I/O: 1 x 8-bit digital I/O (2x5 pin)
- ◆ Fan Connector: 2 x Smart fan connector (1x4 pin)
- ◆ Chassis Open: 1 x Chassis intrusion (1x2 pin)
- ◆ Power Supply: DC 12V input, 1 x External DC jack (4-pin DIN), 1 x Internal power connector (2x2 pin), Support AT/ATX mode, ErP/EuP Compliant
- ◆ Watchdog Timer: Software Programmable support 1~255 sec. System reset
- ◆ Power Consumption: 12V@11.32A (Intel® Core™ i7-8700 up to 4.60 GHz CPU with two 8GB 2666MHz DDR4 memory)
- ◆ Operating Temperature: 0°C ~ 60°C
- ◆ Storage Temperature: -10°C ~ 70°C
- ◆ Operating Humidity: 5% ~ 95%, non-condensing
- ◆ Dimension: 170mm x 170mm
- ◆ Weight: GW:900g / NW:400g
- ◆ CE/FCC compliant



Features

- LGA1151 Intel® 8th/9th generation Core™ i9/i7/i5/i3, Celeron® and Pentium® processor
- Dual-channel DDR4 2666MHz
- Support internal DisplayPort & Dual HDMI
- Support M.2 A Key for WLAN expansion & M key for storage

Packing List

1 x KINO-DH310 single board computer	1 x SATA cable
1 x I/O Shielding	1 x QIG

Dimensions (Unit: mm)

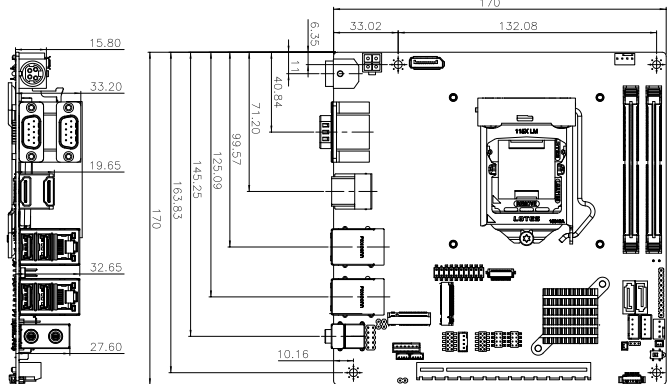

Ordering Information

Part No.	Description
KINO-DH310-R10	Mini-ITX SBC supports 14nm LGA1151 Intel® 8th/9th Generation Core™ i9/i7/i5/i3, Celeron® and Pentium® processor, DDR4, dual independent displays, dual GbE LAN, M.2, SATA 6Gb/s, HD Audio and RoHS
KINO-DH310-DP-R10**	Mini-ITX SBC supports 14nm LGA1151 Intel® 8th/9th Generation Core™ i9/i7/i5/i3, Celeron® and Pentium® processor, DDR4, dual independent displays, dual GbE LAN, M.2, SATA 6Gb/s, HD Audio, DP and RoHS
32001-008600-200-RS	Dual port USB cable, 210mm, P=2.0
32006-001100-201-RS	PS/2 KB/MS cable, 135mm, P=2.0
32205-002700-200-RS	RS-232 cable, 200mm, P=2.0
CF-115XA-R10	High performance LGA115X cooler kit, 1U chassis compatible, 73W
CF-1156C-R20	LGA1155/LGA1156 cooler kit, 1U chassis compatible, 45W
CF-1156D-R30	LGA1155/LGA1156 cooler kit, 1U chassis compatible, 65W
CF-115XE-R10	High-performance LGA1155/1156 cooler kit, 95W
TPM-IN02-R20	20-pin Infineon TPM 2.0 module, software management tool, firmware v5.5

** By order production, MOQ: 100

KINO-DAL

Mini-ITX SBC supports Intel® 14nm Atom™, Pentium® or Celeron® on-board SoC with HDMI/LVDS/VGA, Dual PCIe GbE, USB 3.2 Gen 1 (5Gb/s), PCIe Mini, M.2, SATA 6Gb/s, COM, Audio and RoHS

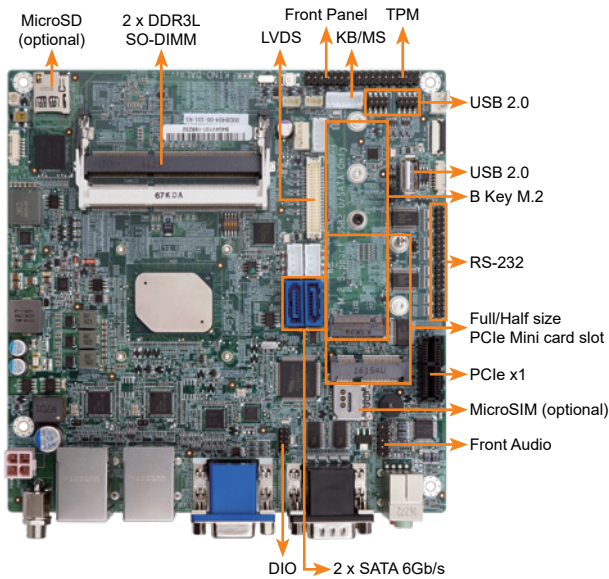

Triple Independent Displays

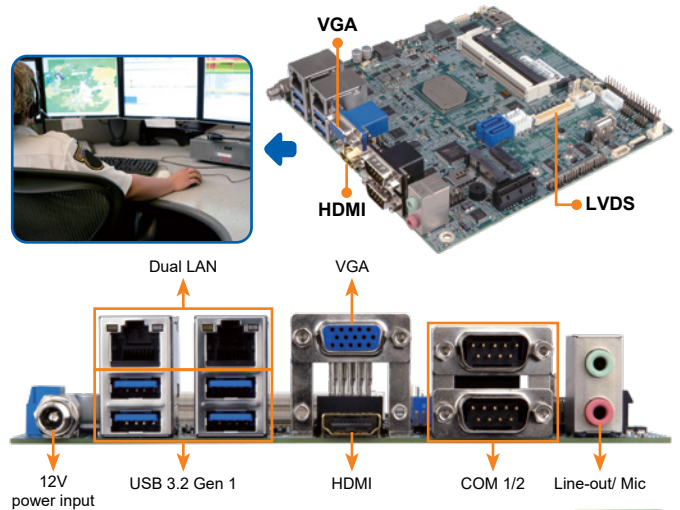

Specifications

- ◆ SoC
 - Intel® Atom® x7-E3950 on-board SoC (up to 2.0GHz, quad-core, 2M Cache, TDP=12W)
 - Intel® Atom® x5-E3940 on-board SoC (up to 1.8GHz, quad-core, 2M Cache, TDP=9W)
 - Intel® Atom® x5-E3930 on-board SoC (up to 1.8GHz, dual-core, 2M Cache, TDP=6W)
 - Intel® Pentium® N4200 on-board SoC (up to 2.5GHz, quad-core, 2M Cache, TDP=6W)
 - Intel® Celeron® N3350 on-board SoC (up to 2.4GHz, dual-core, 2M Cache, TDP=6W)
- ◆ BIOS
 - UEFI BIOS
- ◆ Memory
 - Two 204-pin 1866/1600MHz Dual-channel DDR3L SO-DIMMs support up to 8GB
- ◆ Graphics Engine
 - Intel® HD Graphics Gen9 Low Power; 18 Execution Units
 - 4K Codec Decode & Encode for HEVC 4, H.264, VP8, SVC, MVC
- ◆ Display Output
 - Triple independent display
 - 1 x 18/24-bit dual-channel LVDS (up to 1920x1200@60Hz)
 - 1 x VGA (up to 1920x1200@60Hz)
 - 1 x HDMI (up to 3840x2160@30Hz)
- ◆ Ethernet: 2 x PCIe GbE LAN Intel® i211 AT controller
- ◆ External I/O Interface
 - 4 x USB 3.2 Gen 1 (5Gb/s)
 - 2 x RS-232/422/485
- ◆ Internal I/O Interface
 - 1 x eMMC 5.0 (optional, up to 32G)
 - 1 x MicroSD card slot (optional)
 - 1 x USB 2.0 (180° Type-A)
 - 2 x SATA 6Gb/s with 12/5V SATA power connector
 - 1 x KB/MS (1x6 pin)
 - 4 x RS-232 (2x5 pin, P=2.0)
 - 4 x USB 2.0 (2x4 pin, P=2.0)
- ◆ SMBus: 1 x SMBus (1x4 pin)
- ◆ PC: 1 x PC (1x4 pin)
- ◆ TPM: 1 x TPM (2x10 pin)
- ◆ Audio
 - Realtek ALC888S HD Audio codec
 - 2 x Audio jacks (line-out, mic-in) on rear IO
 - 1 x Front audio (2x5 pin)
- ◆ Front Panel
 - 1 x Front panel (2x7 pin, power LED, HDD LED, speaker, power button, reset button)
- ◆ LAN LED: 2 x LAN LED (1x2 pin)
- ◆ Expansion
 - 1 x PCIe x1 card slot
 - 1 x Full/Half-size PCIe Mini card slot
 - 1 x M.2 B key (2242/2260/2280, USB 2.0 & colay SATA2)
- ◆ Digital I/O: 8-bit digital I/O (2x5 pin)
- ◆ Fan Connector
 - 1 x CPU smart fan (1x4 pin)
 - 1 x System smart fan (1x3 pin)
- ◆ Power Supply
 - 12V only DC input as Default/ 9V~30V DC input (optional)
 - 1 x Internal power connector (2x2 pin)
 - 1 x External DC power Jack (Ø5.5mm)
 - Support AT/ATX mode
- ◆ Watchdog Timer
 - Software programmable, supports 1~255 sec. system reset
- ◆ Power Consumption
 - 12V@3.64A (Intel® Pentium® N4200 CPU with two 8GB 1600MHz DDR3L memory)
- ◆ Operating Temperature: -20°C ~ 70°C / -40°C ~ 85°C (KINO-DAL-ExW2)
- ◆ Storage Temperature: -40°C ~ 85°C
- ◆ Operating Humidity: 5% ~ 95%, non-condensing
- ◆ Dimensions: 170mm x 170mm
- ◆ Weight: GW: 1100g / NW: 700g
- ◆ CE/FCC compliant



Features

- Mini-ITX SBC supports Intel® 14nm Atom®, Pentium® or Celeron® on-board SoC supports dual-channel DDR3L SO-DIMMs
- Triple independent display support
- Optional wide range 9V~30V DC input design
- Full size PCIe Mini slot for 3G/LTE expansion
- COM, USB 3.2 Gen 1 (5Gb/s), SATA 6Gb/s, M.2, eMMC 5.0 and audio support

Packing List

1 x KINO-DAL single board computer with heatsink	1 x I/O Shielding
1 x SATA with power cable kit	1 x QIG

Ordering Information

Part No.	Description
KINO-DAL-N2-R10**	Mini-ITX SBC supports Intel® 14nm quad-core Pentium® N4200 2.5GHz on-board SoC with HDMI/LVDS/VGA, Dual PCIe GbE, USB 3.2 Gen 1 (5Gb/s), PCIe Mini, M.2, SATA 6Gb/s, COM, Audio and RoHS
KINO-DAL-N1-R10	Mini-ITX SBC supports Intel® 14nm dual-core Celeron® N3350 2.3GHz on-board SoC with HDMI/LVDS/VGA, Dual PCIe GbE, USB 3.2 Gen 1 (5Gb/s), PCIe Mini, M.2, SATA 6Gb/s, COM, Audio and RoHS
KINO-DAL-J2-R10	Mini-ITX SBC supports Intel® 14nm quad-core Celeron® J3455 2.3GHz on-board SoC with HDMI/LVDS/VGA, Dual PCIe GbE, USB 3.2 Gen 1 (5Gb/s), PCIe Mini, M.2, SATA 6Gb/s, COM, Audio and RoHS
KINO-DAL-E3W2-R10**	Mini-ITX SBC supports Intel® 14nm quad-core Atom® x7-E3950 2.0GHz on-board SoC with HDMI/LVDS/VGA, Dual PCIe GbE, USB 3.2 Gen 1 (5Gb/s), PCIe Mini, M.2, SATA 6Gb/s, COM, Audio and RoHS, -40°C ~ 85°C
KINO-DAL-E2W2-R10**	Mini-ITX SBC supports Intel® 14nm quad-core Atom® x5-E3940 1.8GHz on-board SoC with HDMI/LVDS/VGA, Dual PCIe GbE, USB 3.2 Gen 1 (5Gb/s), PCIe Mini, M.2, SATA 6Gb/s, COM, Audio and RoHS, -40°C ~ 85°C
KINO-DAL-E1W2-R10**	Mini-ITX SBC supports Intel® 14nm dual-core Atom® x5-E3930 1.8GHz on-board SoC with HDMI/LVDS/VGA, Dual PCIe GbE, USB 3.2 Gen 1 (5Gb/s), PCIe Mini, M.2, SATA 6Gb/s, COM, Audio and RoHS, -40°C ~ 85°C
32001-008600-200-RS	Dual-port USB cable, 210mm, P=2.0
32006-001100-201-RS	PS/2 KB/MS cable, 135mm, P=2.0
32205-002700-200-RS	RS-232 cable, 200mm, P=2.0
TPM-IN02-R20	20-pin Infineon TPM 2.0 module, software management tool, firmware v5.5

**By order production, MOQ: 100

KINO-DQM170

Mini-ITX SBC supports 6th Intel® Core™ Mobile CPU, HDMI 2.0, M.2, SATA 6Gb/s, dual Intel® GbE, USB 3.2 Gen 1 (5Gb/s), PCIe Mini, HD Audio and RoHS

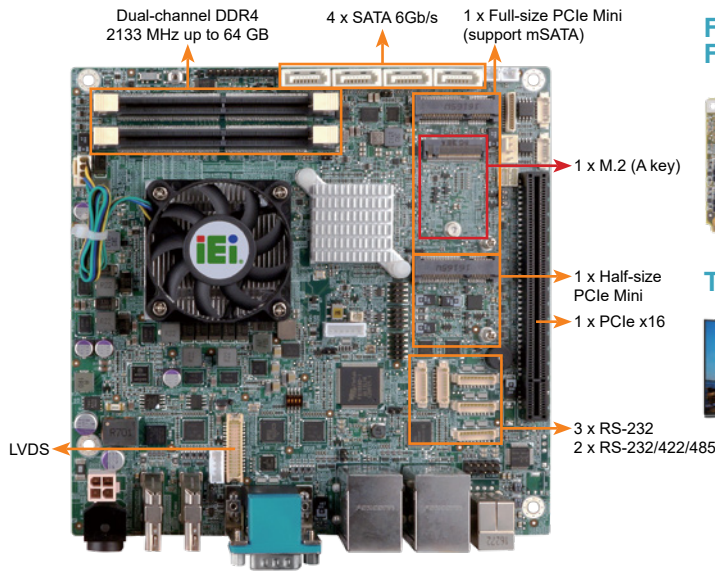

Flexible Selection of Modules with Different Functions

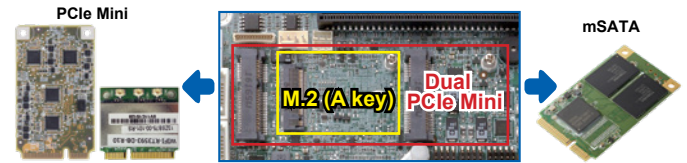

Triple Independent Displays

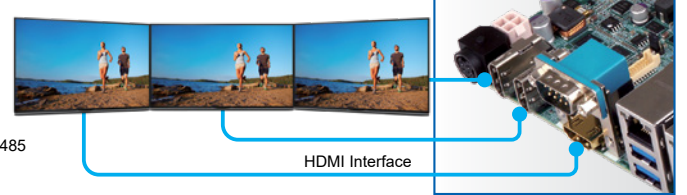

Specifications

- ◆ CPU
 - 6th generation Intel® Core™ mobile processor
 - Intel® Core™ i3-6102E (up to 1.90GHz, dual-core, 3M cache, TDP=25W)
- ◆ Chipset: Intel® QM170
- ◆ BIOS: UEFI BIOS
- ◆ Memory
 - Two 260-pin 2133/1866 MHz dual-channel unbuffered DDR4 SDRAM SO-DIMMs support up to 64GB
- ◆ Graphics Engine
 - Intel® HD Graphics Gen 9 support for DX11/12, OCL 2.x, OGL 4.3/4.4, ES 2.0
- ◆ Display Output
 - Triple independent display
 - 2 x HDMI 1.4 (up to 4096x2160@24Hz)
 - 1 x HDMI 2.0 (up to 4096x2160@60Hz)
 - 1 x 18/24-bit dual-channel LVDS (up to 1920x1200@60Hz)
- ◆ Ethernet
 - LAN1: Intel® I219LM with (Intel® AMT 11.0 support)
 - LAN2: Intel® I211 PCIe controller with NCSI support
- ◆ External I/O Interface
 - 4 x USB 3.2 Gen 1 (5Gb/s)
 - 1 x RS-232
- ◆ Internal I/O Interface
 - 1 x KB/MS (1x6 pin, P=2.0)
 - 4 x SATA 6Gb/s (RAID 0/1/5/10 support)
 - 2 x RS-232/422/485 (1x9 pin, P=1.25)
 - 4 x USB 2.0 (2x4 pin, P=2.0)
 - 3 x RS-232 (1x9 pin, P=1.25)
- ◆ Audio
 - Realtek ALC888S HD Audio codec supports 7.1-channel
 - 2 x audio jacks(line out, mic in) on rear I/O (colay with 3x audio jack)
 - 1 x Front audio (2x5 pin)
- ◆ Front Panel
 - 1 x Front panel (2x7 pin, power LED, HDD LED, speaker, power button, reset button)
- ◆ LAN LED: 2 x LAN LED (1x2 pin)
- ◆ SMBus: 1 x SMBus (1x4 pin)
- ◆ I²C: 1 x I²C (1x4 pin)
- ◆ Digital I/O: 8-bit digital I/O (2x5 pin)
- ◆ Expansion
 - 1 x PCIe x16 slot
 - 1 x Full-size PCIe Mini card slot (support mSATA)
 - 1 x M.2 2230 (A key)
 - 1 x Half-size PCIe Mini card slot
- ◆ Cooler Module
 - 19100-000219-00-RS for Intel® Core™ i7/i5 (45W)
 - 19100-000203-00-RS for Intel® Core™ i3/Celeron® (25W)
- ◆ Watchdog Timer
 - Software programmable supports 1~255 sec. system reset by super I/O
- ◆ Chassis Intrusion Detection: 1 x Chassis intrusion connector (1x2 pin)
- ◆ Power Supply
 - 12V DC input
 - 1 x External DC jack (4-pin DIN)
 - 1 x Internal power connector (2x2 pin)
 - Support AT/ATX mode
- ◆ Fan Connector
 - 1 x CPU smart (1x4 pin)
 - 1 x System fan (1x4 pin)
- ◆ Power Consumption
 - 12V@5.08A (Intel® Core™ i7-6820EQ, 3.5GHz CPU with 16 GB (two 8 GB) 2133 MHz DDR4 memory)
- ◆ Operating Temperature: -20°C ~ 60°C
- ◆ Operating Humidity: 5% ~ 95%, non-condensing
- ◆ Dimensions: 170mm x 170 mm
- ◆ Weight: 900g / NW: 450g
- ◆ CE/FCC compliant

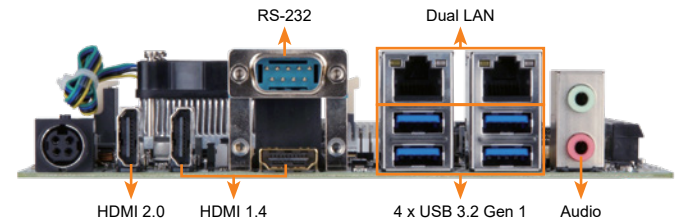

Features

- Mini ITX form factor with 6th Gen Intel® Core™ i7/i5/i3/Celeron® processor support
- DDR4 memory
- Support HDMI 2.0 (4096x2160@60Hz)
- Triple display with independent audio via HDMI
- PCIe x16, dual PCIe Mini and M.2 A key feature support for various function module
- Rich High speed I/O interface for USB 3.2 Gen 1 (5Gb/s) and SATA 6Gb/s
- Support IEI jumpless

Packing List

1 x KINO-DQM170 single board computer with CPU cooler
2 x SATA cable
1 x I/O shielding
1 x QIG

Ordering Information

Part No.	Description
KINO-DQM170-i3E-R11	Mini-ITX SBC with BGA 1440 supports 6th Gen Intel® Core™ i3-6102E processor, HDMI 2.0, SATA 6Gb/s, dual Intel® GbE, USB 3.2 Gen 1 (5Gb/s), PCIe Mini, M.2, HD Audio and RoHS
32001-008600-200-RS	Dual-port USB cable, 210mm, P=2.0
32005-003500-200-RS	RS-232/422/485 cable, 250mm, P=1.25
32006-001100-201-RS	PS/2 KB/MS cable, 135mm/110mm, P=2.0

KINO-AQ170

Mini-ITX SBC supports LGA 1151 Intel® Core™ i7/i5/i3, Pentium® or Celeron® CPU with Intel® Q170, HDMI 2.0/HDMI+DP/VGA, Dual Intel® GbE, SATA 6Gb/s, USB 3.2 Gen 1 (5Gb/s), PCIe Mini, HD Audio and RoHS

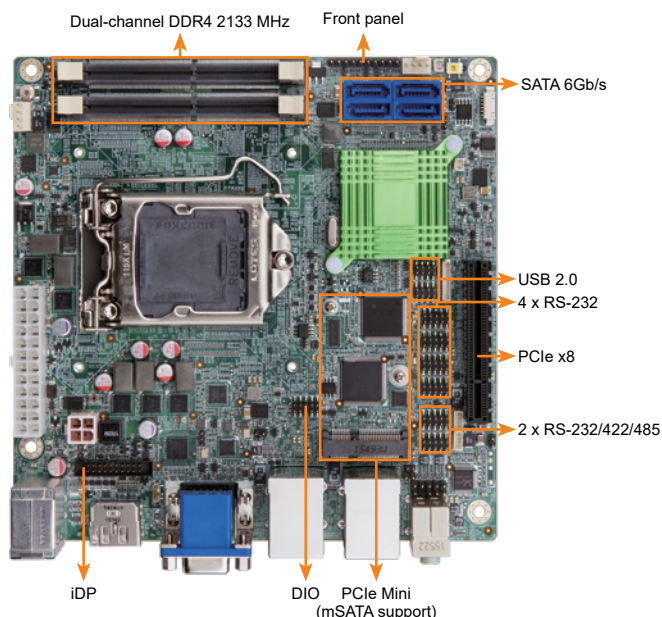

HDMI 2.0

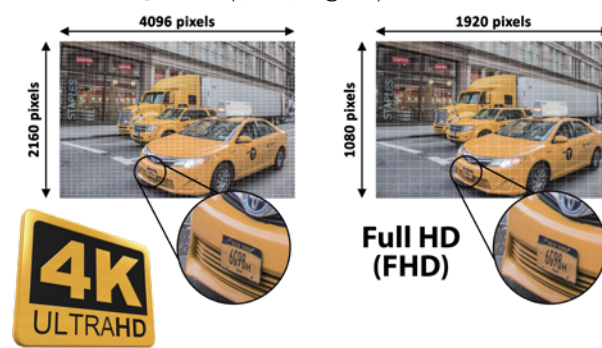

	HDMI 1.4	HDMI 2.0
Bandwidth	10.2Gbps	18Gbps
4K@30hz	Yes	Yes
4K@60hz	No	Yes
Up to 32 Audio Channels	No	Yes

Specifications

- ◆ CPU
LGA 1151 socket supports Intel® 6th/7th generation Core™ i7/i5/i3, Pentium® or Celeron® processor
- ◆ Chipset
Intel® Q170
- ◆ BIOS
UEFI BIOS
- ◆ Memory
Two 260-pin 2133 MHz dual-channel DDR4 SDRAM SO-DIMM support up to 64GB
- ◆ Graphics Engine
Intel® HD Graphics Gen 9 support for DX11/12, OCL 2.x, OGL 4.3/4.4, ES 2.0 Decode/Encode for HEVC, VP8, VP9 2, VDENC
- ◆ Display Output
Triple independent display
1 x HDMI 2.0 (up to 4096x2160@60Hz)
1 x HDMI/DP (up to 3840x2160@60Hz)
1 x VGA (up to 1920x1200)
1 x iDP interface for HDMI, LVDS, VGA, DVI, DP (up to 3840x2160@60Hz)
- ◆ Ethernet
LAN1: Intel® I219LM with (Intel® AMT 11.0 support)
LAN2: Intel® I211 PCIe controller with NCSI support
- ◆ External I/O Interface
2 x USB 2.0
4 x USB 3.2 Gen 1 (5Gb/s)
- ◆ Internal I/O Interface
2 x RS-232/422/485 (2x5 pin, P=2.0)
4 x RS-232 (2x5 pin, P=2.0)
4 x SATA 6Gb/s (RAID 0/1/5/10 supported)
4 x USB 2.0 (2x4 pin, P=2.0)
- ◆ Audio
Realtek ALC888S HD Audio codec
2 x Audio jacks (line-out, mic-in) on rear IO
1 x Front audio (2x5 pin)
- ◆ Front Panel
1 x Front panel (1x10 pin, power LED, HDD LED, power button, reset button)
- ◆ LAN LED: 2 x LAN LED (1x2 pin)
- ◆ SMBus: 1 x SMBus (1x4 pin)
- ◆ I²C: 1 x I²C (1x4 pin)
- ◆ Digital I/O: 8-bit digital I/O (2x5 pin)
- ◆ Expansion
1 x PCIe x8 slot
1 x Full-size PCIe Mini card slot (support mSATA)
- ◆ Chassis Intrusion Detection: 1 x Chassis intrusion connector (1x2 pin)
- ◆ Watchdog Timer
Software programmable supports 1~255 sec. system reset by super I/O
- ◆ Power Supply
ATX power supply
- ◆ Fan Connector
1 x CPU smart fan (1x4 pin)
1 x System smart fan (1x4 pin)
- ◆ Power Consumption
3.3V@0.62A, 5V@3.3A, 12V@7.51A, 5VSB@0.23A
(Intel® Core™ i7 6700K 4.0GHz CPU with 16 GB (two 8 GB) 2133 MHz DDR4 memory)
- ◆ Operating Temperature: -20°C ~ 60°C
- ◆ Operating Humidity: 5% ~ 95%, non-condensing
- ◆ Dimensions: 170mm x 170mm
- ◆ Weight: GW: 900g / NW: 450g
- ◆ CE/FCC compliant

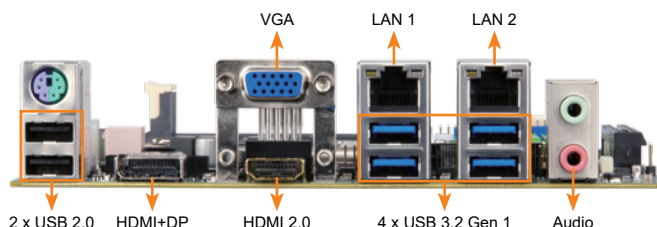

Features

- LGA 1151 Intel® 6th/7th generation Core™ i7/i5/i3, Pentium® or Celeron® processor and DDR4 2133MHz memory support
- Support HDMI 2.0 (4096x2160@60Hz)
- Dual Intel® GbE support Intel® AMT 11.0
- Triple display via HDMI 2.0/HDMI/DP 1.2/VGA/iDP
- High speed I/O interface for USB 3.2 Gen 1 (5Gb/s), SATA 6Gb/s and mSATA support
- Support IEL jumpless

Packing List

1 x KINO-AQ170 single board computer	2 x SATA cable
1 x I/O shielding	1 x QIG

Ordering Information

Part No.	Description
KINO-AQ170-R10	Mini-ITX SBC supports 6th generation Intel® Core™ i7/i5/i3, Pentium® and Celeron® processor, HDMI 2.0/HDMI/DP/VGA, SATA 6Gb/s, dual Intel® GbE, USB 3.2 Gen 1 (5Gb/s), PCIe Mini, HD Audio and RoHS
32001-008600-200-RS	Dual-port USB cable, 210mm, P=2.0
32205-002700-200-RS	RS-232/422/485 cable, 230mm, P=2.0
CF-1156C-R20	LGA1155/LGA1156 cooler kit, 1U chassis compatible, 45W
CF-1156D-R30	LGA1155/LGA1156 cooler kit, 1U chassis compatible, 65W
CF-115XE-R10	High performance LGA1155/LGA1156 cooler kit, 95W
DP-DP-R10	DisplayPort to DP converter board (for IEL connector)
DP-DVI-R10	DisplayPort to DVI-D converter board (for IEL connector)
DP-HDMI-R10	DisplayPort to HDMI converter board (for IEL connector)
DP-LVDS-R10	DisplayPort to 24-bit dual-channel LVDS converter board (for IEL connector)
DP-VGA-R10	DisplayPort to VGA converter board (for IEL connector)

KINO-DBT

Mini-ITX SBC supports 22nm Intel® Atom™ or Celeron® on-board SoC, VGA/DVI/iDP, dual Realtek PCIe GbE, USB 3.2 Gen 1 (5Gb/s), SATA, HD Audio, RoHS

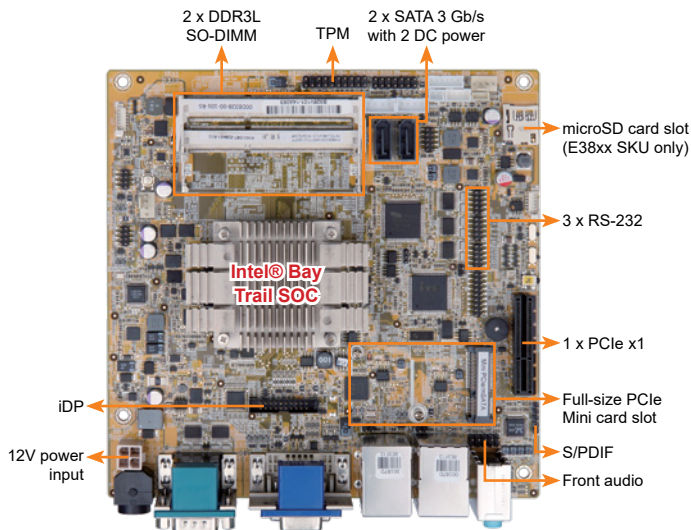

Specifications

- ◆ SoC
 - Intel® Celeron® J1900 on-board SoC (2GHz, quad-core, 2MB cache, TDP=10W)
 - Intel® Celeron® N2807 on-board SoC (1.58GHz, dual-core, 2MB cache, TDP=4.5W)
- ◆ BIOS
 - UEFI BIOS
- ◆ Memory
 - Two 204-pin 1066/1333 MHz dual-channel unbuffered DDR3L SDRAM SO-DIMM support up to 8 GB (J1900, N2930, E3845, E3827, E3826)
 - One 204-pin 1066/1333 MHz dual-channel unbuffered DDR3L SDRAM SO-DIMM supports up to 8 GB (E3825, E3815) or 4 GB (N2807)
- ◆ Graphics Engine
 - Intel® HD Graphics Gen 7 engine with 4 execution units, supporting DX11.1, OpenGL 4.2 and OpenCL1.2
- ◆ Display Output
 - Dual independent display
 - 1 x VGA (up to 2560x1600@60 Hz)
 - 1 x DVI-D (up to 1920x1080@60 Hz)
 - 1 x iDP interface for HDMI, LVDS, VGA, DVI, DP (up to 2560x1600@60 Hz)
- ◆ Ethernet
 - LAN1: Realtek RTL8111HN PCIe GbE controller
 - LAN2: Realtek RTL8111HN PCIe GbE controller
- ◆ External I/O Interface
 - 2 x RS-232
 - 2 x USB 2.0
 - 2 x USB 3.2 Gen 1 (5Gb/s)
- ◆ Internal I/O Interface
 - 1 x KB/MS (1x6 pin)
 - 1 x mSATA (colay SATA2)
 - 2 x SATA 3Gb/s
 - 4 x USB 2.0 (2x4 pin, P=2.0)
 - ◆ SMBus: 1 x SMBus (1x4 pin)
 - ◆ TPM: 1 x TPM (2x10 pin)
 - ◆ Audio
 - Realtek ALC888S HD Audio codec supports 7.1-channel
 - 3 x Audio jacks (line-out, line-in, mic-in) on rear IO
 - 1 x Front audio (2x5 pin)
 - 1 x S/PDIF (1x5 pin)
 - ◆ Front Panel
 - 1 x Front panel (2x7 pin, power LED, HDD LED, speaker, power button, reset button)
 - ◆ LAN LED: 2 x LAN LED (1x2 pin)
 - ◆ Expansion
 - 1 x PCIe x4 slot (with PCIe x1 signal)
 - 1 x Full-size PCIe Mini card slot
 - ◆ Digital I/O: 8-bit digital I/O (2x5 pin)
 - ◆ Chassis Intrusion Detection: 1 x Chassis intrusion connector (1x2 pin)
 - ◆ Fan Connector
 - 1 x CPU smart fan (1x4 pin)
 - 1 x System smart fan (1x4 pin)
 - ◆ Power Supply
 - 12V DC input
 - 1 x External DC jack (4-pin DIN)
 - 1 x Internal power connector (2x2 pin)
 - ◆ Power Consumption
 - 12V@1.64A (Intel® Celeron® J1900 CPU with 4 GB 1333 MHz DDR3L memory)
 - ◆ Watchdog Timer: Software programmable supports 1~255 sec. system reset
 - ◆ Operating Temperature: -20°C ~ 60°C
 - ◆ Storage Temperature: -30°C ~ 70°C
 - ◆ Operating Humidity: 5% ~ 95%, non-condensing
 - ◆ Dimensions: 170mm x 170mm
 - ◆ Weight: GW: 900g / NW: 400g
 - ◆ CE/FCC compliant

iDP (IEI Internal DisplayPort)

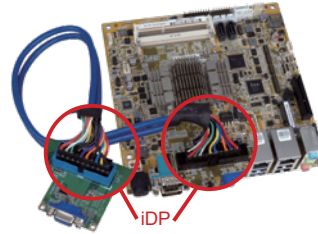

Model	Output	External Power
DP-VGA-R10	VGA	No
DP-HDMI-R10	HDMI	No
DP-DVI-R10	DVI	No
DP-LVDS-R10	LVDS	Yes
DP-DP-R10	DP	No

Easy Installation on the Chassis

iDP converter cards with brackets

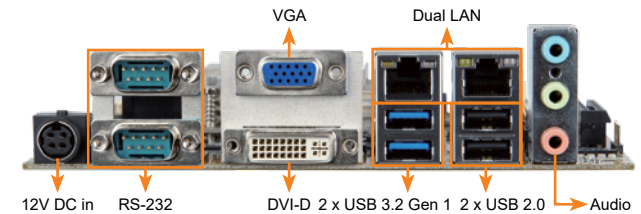

Features

- Mini-ITX SBC with 22nm Intel® Atom™ on-board SoC
- 1.35V DDR3L 1066/1333 MHz SDRAM supporting up to 8 GB of memory
- Dual independent display support
- COM, USB 3.2 Gen 1 (5Gb/s), SATA 6Gb/s, PCIe Mini, mSATA and HD Audio support
- Support Intel® VT-x technology

Packing List

1 x KINO-DBT single board computer	1 x SATA cable with power output cable
1 x IO shielding	1 x QIG

Ordering Information

Part No.	Description
KINO-DBT-J19001-R10	Mini-ITX SBC supports Intel® Celeron® quad-core processor J1900 (10W), VGA/DVI/iDP, Dual PCIe GbE, USB 3.2 Gen 1 (5Gb/s), SATA, HD Audio and RoHS
KINO-DBT-N28071-R10	Mini-ITX SBC supports Intel® Celeron® dual-core processor N2807 (4.5W), VGA/DVI/iDP, Dual PCIe GbE, USB 3.2 Gen 1 (5Gb/s), SATA, HD Audio and RoHS
19800-000075-RS	PS/2 KB/MS cable with bracket, 220mm, P=2.0
32205-002700-200-RS	RS-232 cable, 200mm, P=2.0
32205-003800-300-RS	RS-422/485 cable, 200mm, P=2.0
DP-DP-R10	DisplayPort to DisplayPort converter board (for IEI iDP connector)
DP-DVI-R10	DisplayPort to DVI-D converter board (for IEI iDP connector)
DP-HDMI-R10	DisplayPort to HDMI converter board (for IEI iDP connector)
DP-LVDS-R10	DisplayPort to 24-bit dual-channel LVDS converter board (for IEI iDP connector)
DP-VGA-R10	DisplayPort to VGA converter board (for IEI iDP connector)
TPM-IN01-R20	20-pin Infineon TPM module, software management tool, firmware v3.17

eKINO-BT

Mini-ITX SBC supports AUPS sub-system, 22nm Intel® Atom™/Celeron® on-board SoC, wide-range 9V ~ 26V DC input, VGA/dual LVDS, SATA, dual GbE, USB 3.2 Gen 1 (5Gb/s), audio, CFast and RoHS

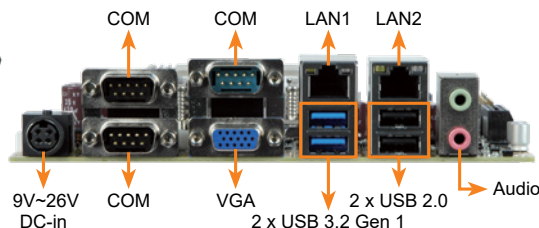
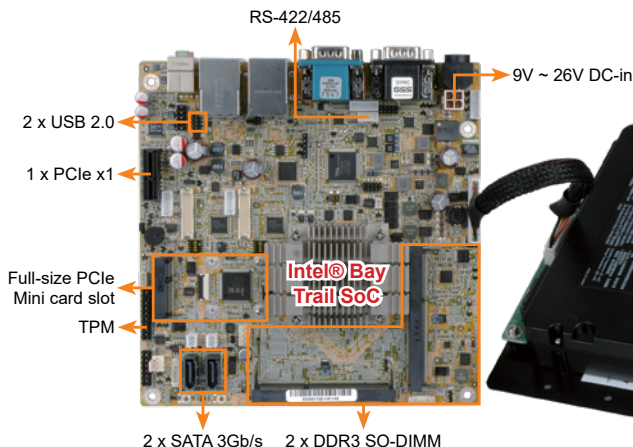

Specifications

- ◆ CPU
 - Intel® Atom™/Celeron® on board SoC(Code name: Bay Trail)(Code name: Bay Trail)
 - Intel® Atom™ E3845 on-board SoC (1.91GHz, quad-core, 2MB cache, TDP=10W)
 - Intel® Atom™ E3827 on-board SoC (1.75GHz, dual-core, 1MB cache, TDP=8W)
 - Intel® Atom™ E3826 on-board SoC (1.46GHz, dual-core, 1MB cache, TDP=7W)
 - Intel® Atom™ E3825 on-board SoC (1.33GHz, dual-core, 1MB cache, TDP=6W)
 - Intel® Atom™ E3815 on-board SoC (1.46GHz, single-core, 512KB cache, TDP=5W)
 - Intel® Celeron® J1900 on-board SoC (2GHz, quad-core, 2MB cache, TDP=10W)
 - Intel® Celeron® N2930 on-board SoC (1.83GHz, quad-core, 2MB cache, TDP=7.5W)
 - Intel® Celeron® N2807 on-board SoC (1.58GHz, dual-core, 2MB cache, TDP=4.3W)
- ◆ BIOS
 - UEFI BIOS
- ◆ Memory
 - Two 204-pin 1066/1333 MHz dual-channel unbuffered DDR3L SDRAM SO-DIMM support up to 8 GB (J1900, N2930, E3845, E3827, E3826)
 - One 204-pin 1066/1333 MHz dual-channel unbuffered DDR3L SDRAM SO-DIMM supports up to 8 GB (E3825, E3815) or 4 GB (N2807)
- ◆ Graphics Engine
 - Intel® HD Graphics Gen 7 Engines with 4 execution units, supporting DX11.1, OpenGL 4.2 and OpenCL1.2
- ◆ Display Output
 - 1 x VGA (up to 2560x1600@60Hz)
 - 2 x 18/24-bit dual-channel LVDS (up to 1920x1200@60Hz)
- ◆ External I/O Interface
 - 2 x USB 2.0
 - 2 x USB 3.2 Gen 1 (5Gb/s)
 - 3 x RS-232
- ◆ Internal I/O Interface
 - 1 x CFast slot
 - 1 x KB/MS (1x6 pin)
 - 1 x MicroSD card slot
 - 1 x RS-232 (2x5 pin, P=2.0)
 - 1 x RS-422/485 (1x4 pin, P=2.0)
 - 2 x SATA 3Gb/s with 5V SATA power connector
 - 2 x USB 2.0 (2x4 pin, P=2.0)
- ◆ Ethernet
 - Dual LAN: Realtek RTL8111E PCIe controller
- ◆ TPM
 - 1 x TPM (2x10 pin)
- ◆ SMBus
 - 1 x SMBus (1x4 pin)
- ◆ Front Panel
 - 1 x Front panel (2x7 pin, power LED, HDD LED, speaker, power button, reset button)
- ◆ LAN LED
 - 2 x LAN LED (1x2 pin)
- ◆ Digital I/O
 - 8-bit digital I/O (2x5 pin)
- ◆ Expansion
 - 1 x PCIe x1 slot
 - 1 x Full-size PCIe Mini card slot
- ◆ Audio
 - Realtek ALC888S HD Audio codec
 - 2 x Audio jacks (line-out, mic-in) on rear IO
 - 1 x Front audio (2x5 pin)
- ◆ Watchdog Timer
 - Software programmable supports 1~255 sec. system reset
- ◆ Power Supply
 - 1 x External DC power jack (4-pin DIN)
 - 1 x Internal power connector (2x2 pin)
 - Input voltage range: 9V ~ 26V
 - Recommended operating input voltage range: 12V~24V
- ◆ Fan Connector
 - 1 x CPU smart fan (1x4 pin)
 - 1 x System fan (1x3 pin)
- ◆ Power Consumption
 - +12V@1.55A (Intel® Celeron® J1900 CPU with two 4 GB 1333 MHz DDR3L memory)
- ◆ Operating Temperature
 - 0°C ~ 40°C with AUPS sub-system
 - 20°C ~ 60°C without AUPS sub-system
- ◆ Storage Temperature
 - 10°C ~ 50°C with AUPS sub-system
 - 30°C ~ 70°C without AUPS sub-system
- ◆ Operating Humidity
 - 5% ~ 95%, non-condensing
- ◆ Weight
 - GW: 1100g / NW: 400g
- ◆ CE/FCC compliant



Features

- Mini ITX supports Intel® 22nm Atom™ or Celeron® on-board SoC
- Wide-range 9V ~ 26V DC input design
- Supports dual independent display with dual LVDS and VGA
- Supports four USB 2.0, two USB 3.2 Gen 1 (5Gb/s), two SATA and four COM
- IEI jumper-less function

Packing List

- 1 x eKINO-BT single board computer
- 2 x SATA with 5V output cable kit
- 1 x I/O shielding
- 1 x QIG

Ordering Information

Part No.	Description
EKINO-BT-J19001-R10	Mini-ITX SBC supports AUPS sub-system, Intel® Celeron® quad-core processor J1900 (10W), wide-range 9V ~ 26V DC input, VGA/dual LVDS, SATA, USB 3.2 Gen 1 (5Gb/s), dual GbE, audio, CFAST and RoHS
EKINO-BT-N29301-R10	Mini-ITX SBC supports AUPS sub-system, Intel® Celeron® quad-core processor N2930 (7.5W), wide-range 9V ~ 26V DC input, VGA/dual LVDS, SATA, USB 3.2 Gen 1 (5Gb/s), dual GbE, audio, CFAST and RoHS
EKINO-BT-N28071-R10	Mini-ITX SBC supports AUPS sub-system, Intel® Celeron® dual-core processor N2807 (4.3W), wide-range 9V ~ 26V DC input, VGA/dual LVDS, SATA, USB 3.2 Gen 1 (5Gb/s), dual GbE, audio, CFAST and RoHS
EKINO-BT-E38XX1-R10**	Mini-ITX SBC supports AUPS sub-system, Intel® Atom™ E38XX on-board SoC, wide-range 9V ~ 26V DC input, VGA/dual LVDS, SATA, dual GbE, USB 3.2 Gen 1 (5Gb/s), audio, CFAST and RoHS (by request MOQ: 100pcs/lot)
19800-000075-RS	PS/2 KB/MS cable with bracket, 220mm, P=2.0
32001-008600-200-RS	Dual-port USB 2.0 cable, 210mm, P=2.0
32205-003800-300-RS	RS-422/485 cable, 200mm, P=2.0
63040-010060-110-RS	60W/12V power adaptor, 90VAC~260VAC, 4-pin DIN
63040-010120-210-RS	120W/19V power adaptor, 90VAC~264VAC, 4-pin DIN
CB-USB02A-RS	Dual-port USB 2.0 cable with bracket, 300mm, P=2.0

**By order production, MOQ: 100

Mini-ITX Dimensions (Unit: mm)

KINO-DH110

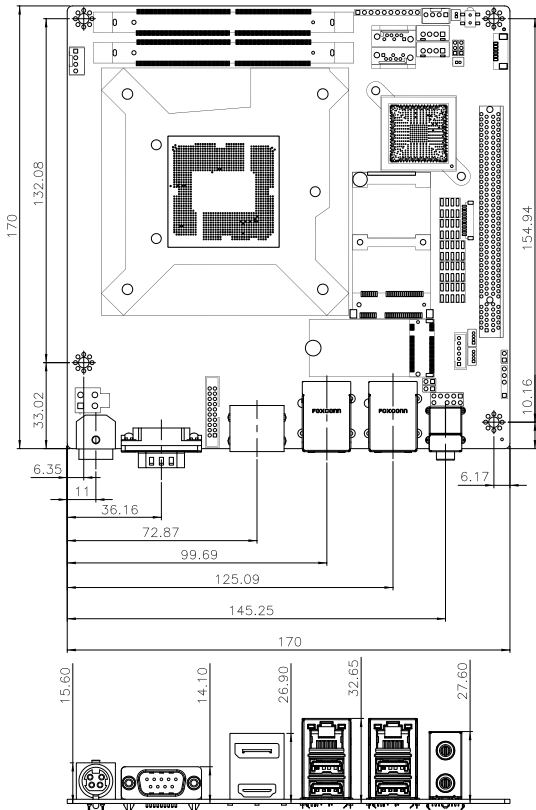

!KINO-AL

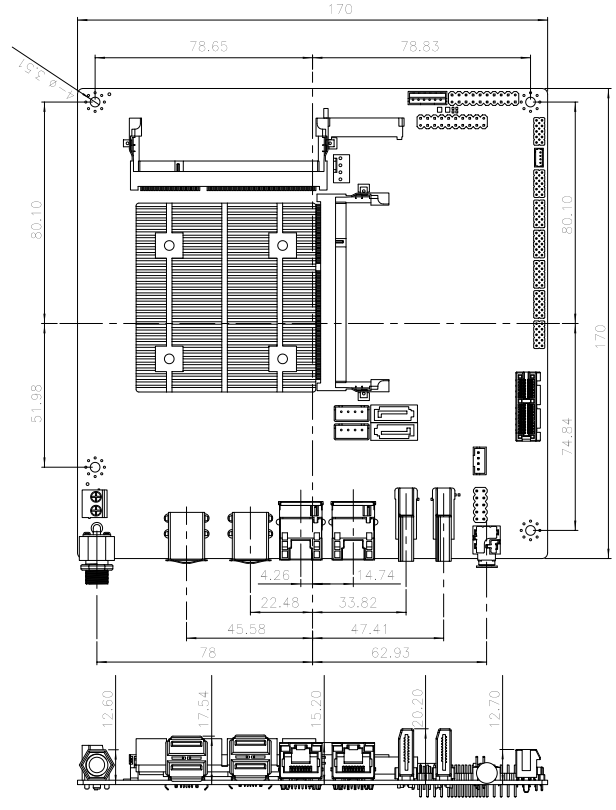

KINO-DAL

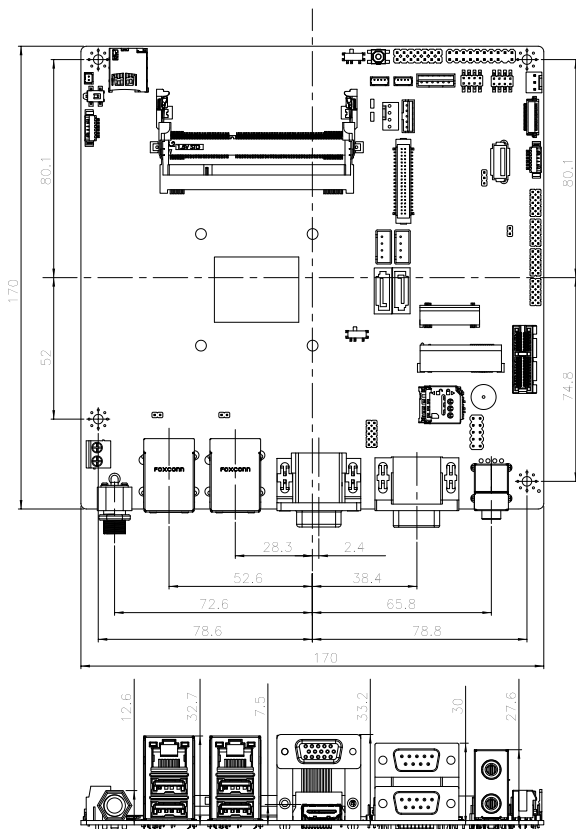

!KINO-ULT3

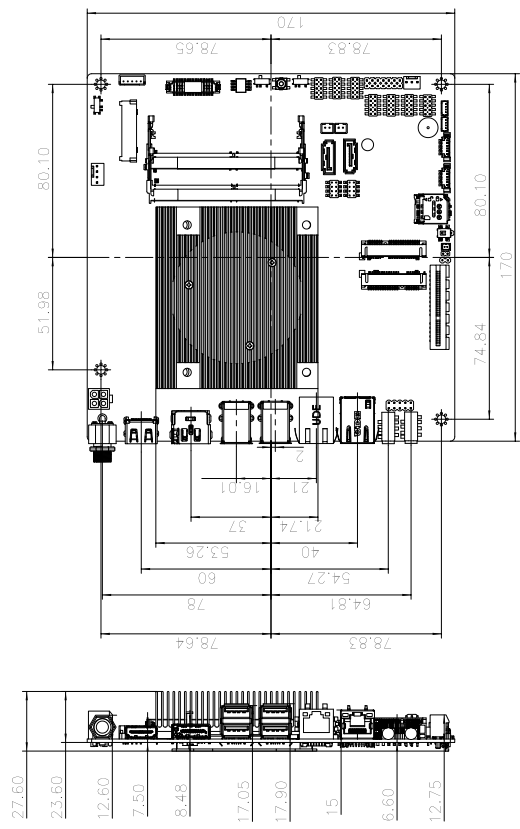

Mini-ITX Dimensions (Unit: mm)

KINO-DCM236

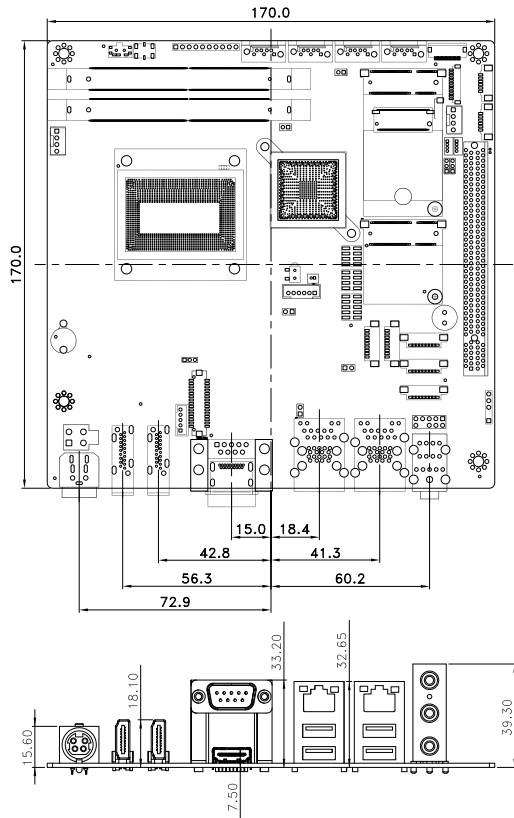

KINO-AQ170

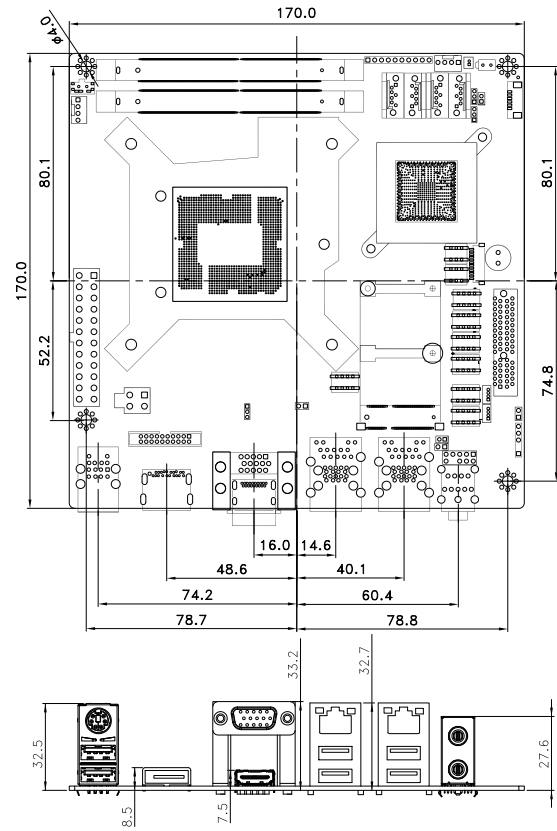

KINO-DQM170

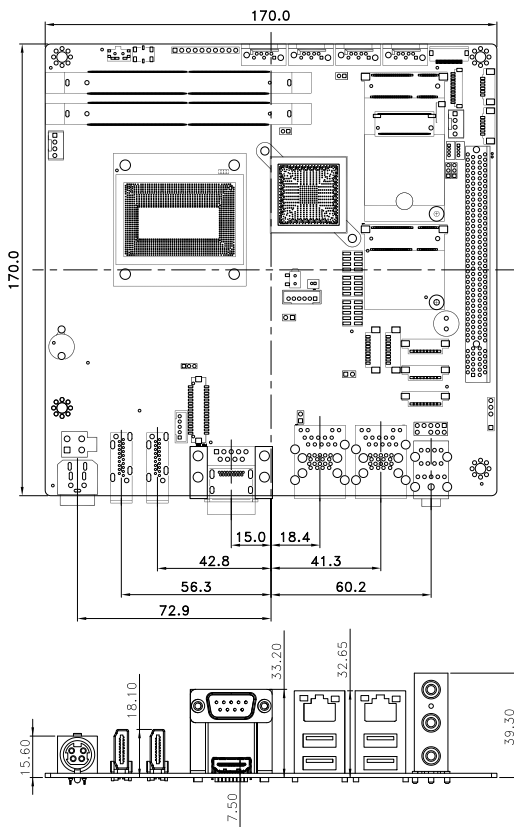

tKINO-BW

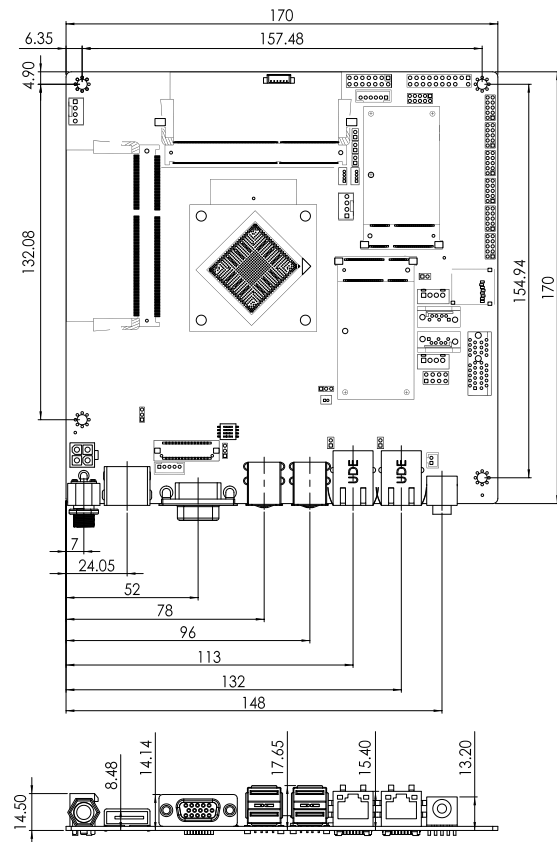

Mini-ITX Dimensions (Unit: mm)

