

# ARM Platform Solution

## Consumer Application Processor RK3566

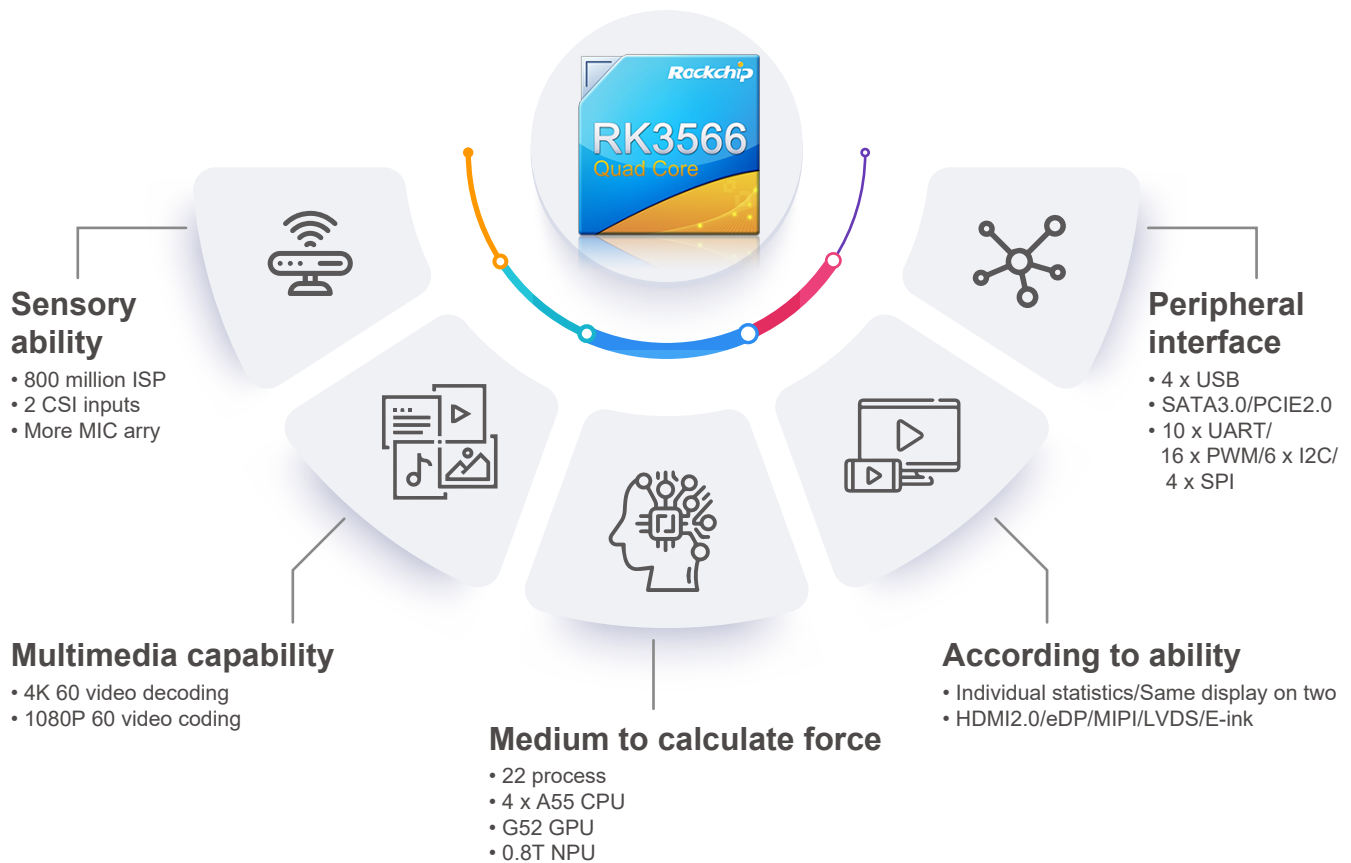

## » RK3566 application scheme

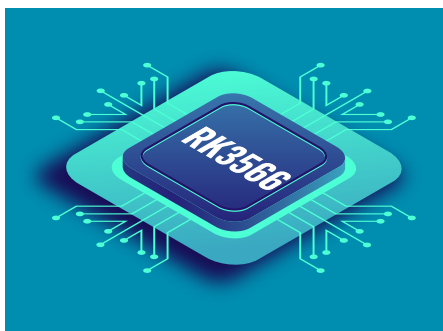

### Features and Positioning

- Intermediate performance processor
- Small and medium size screen consumer applications
- Lightweight AI computing



### line of production

- Consumer: Tablet PC, With screen speakers, OTT BOX
- New retail: With screen POS
- Education/Office: E-Book, Cloud terminal, Video phone, NAS

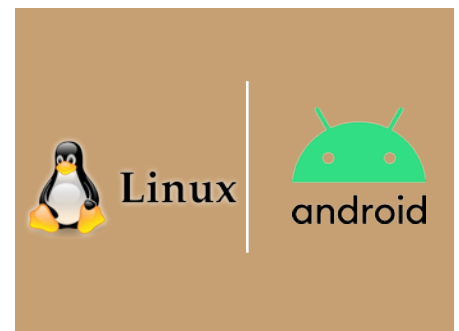

### Support OS

- Android 11
- Linux

## » RK3566 CPU And GPU

### Mali-G52: Premium experiences on mainstream devices

Efficiently support growing graphics & ML complexity

30%

More performance density

15%

Better energy efficiency

3.6x

ML improvements

### Cortex-A55 performance relative to Correx-A53

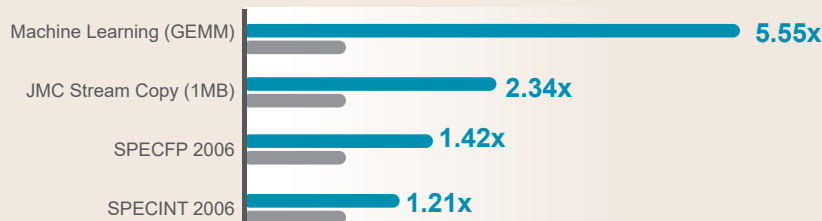

Up to 1.8Ghz

Follow the ARM architecture update iteration

## » RK3566 high efficiency NPU

### RK self-innovate NPU, 0.8Tops

- 512 INT8 MAC
- 128 INT16/FP16/BFP16 MAC
- Up to 800MHz

### Easy to use model transformation tool

- Support Caff/TensroFlow/TF-Lite/ONNX/PyTorch/ Keras/Darknet One-click transformation of mainstream architectural models



### Continue to update and improve the OP

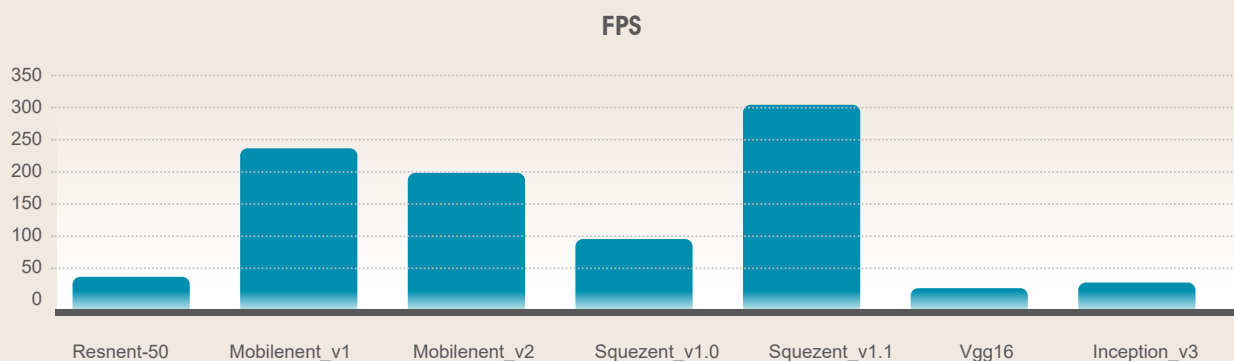

# AIO Processor, RK3568

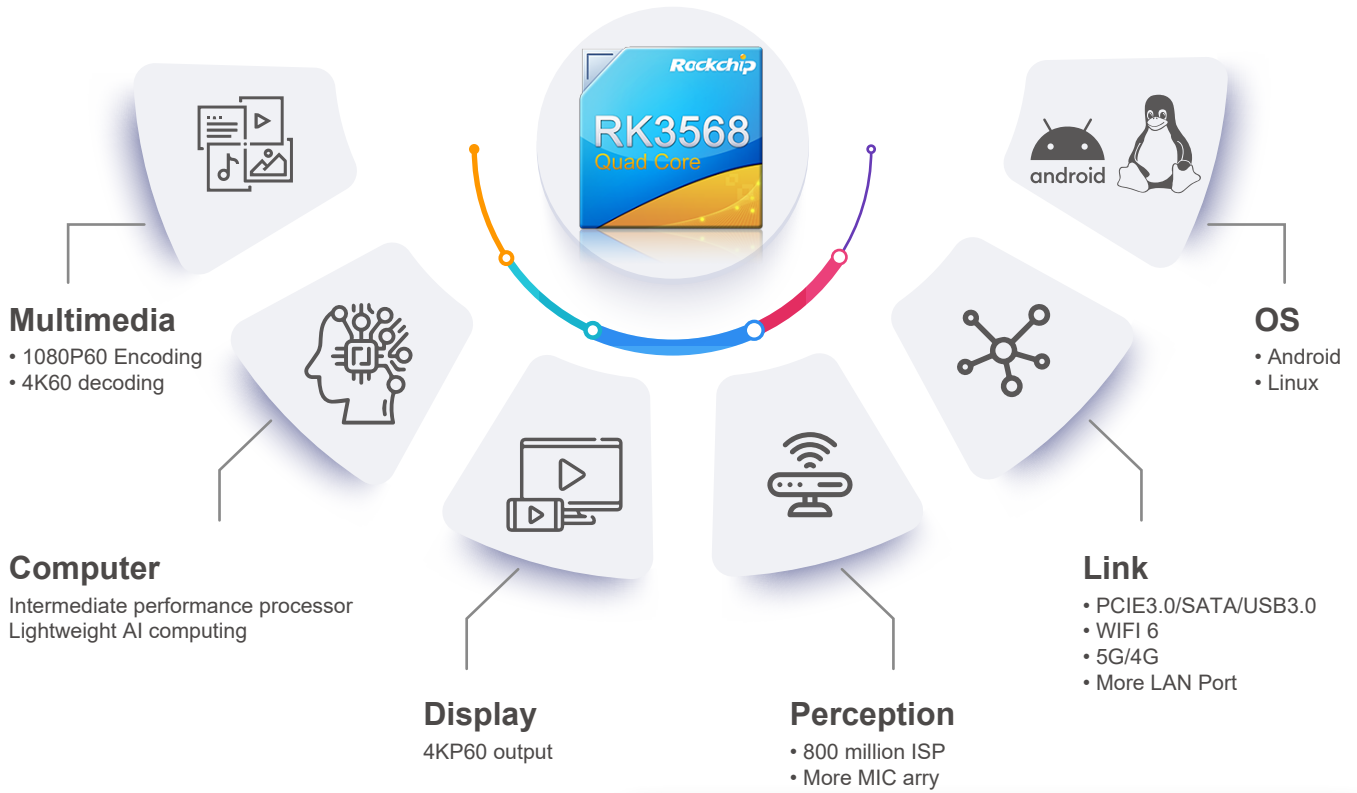

## » RK3568 CPU&GPU

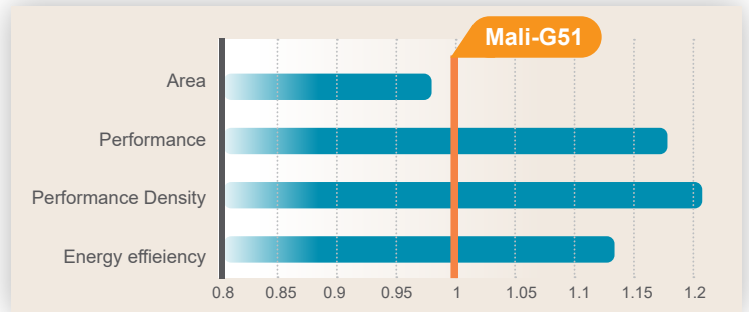

## » RK3568 NPU

### RK self-innovate NPU, 0.8Tops

- 512 INT8 MAC
- 128 INT16/FP16/BFP16 MAC
- Up to 800MHz

### Easy to use model transformation tool

- Support Caff/TensroFlow/TF-Lite/ONNX/PyTorch/Keras/Darknet One-click transformation of mainstream architectural models

### Continue to update and improve the OP

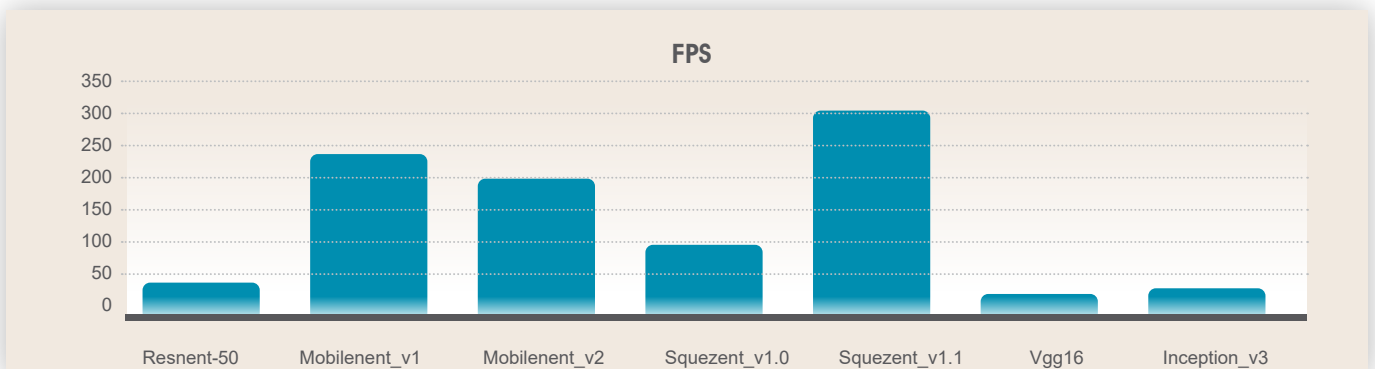

# Cortex™-A53 on Freescale™ i.MX 8M Series

## » i.MX 8M Family of Applications Processors

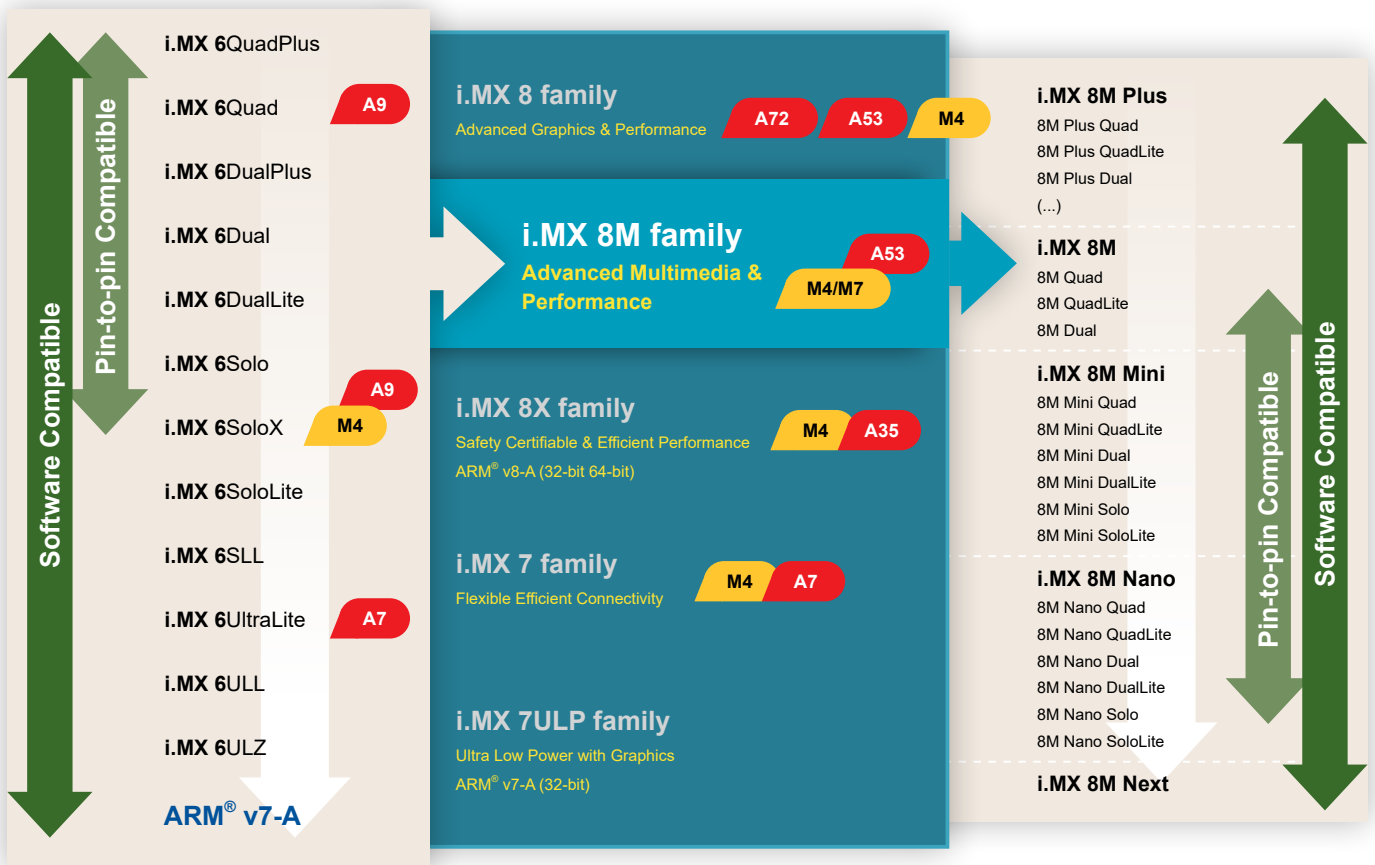

## Cortex™-A53 MPCore

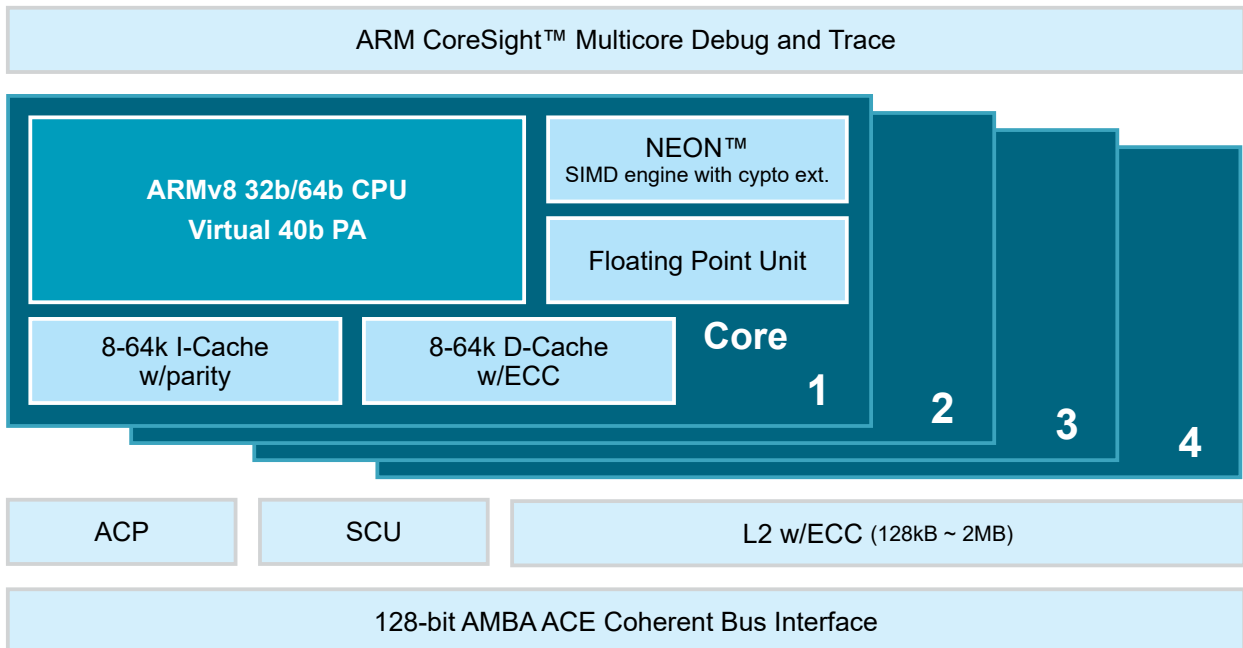

# » i.MX 8M Series: Scalable Solutions for the Broad Market

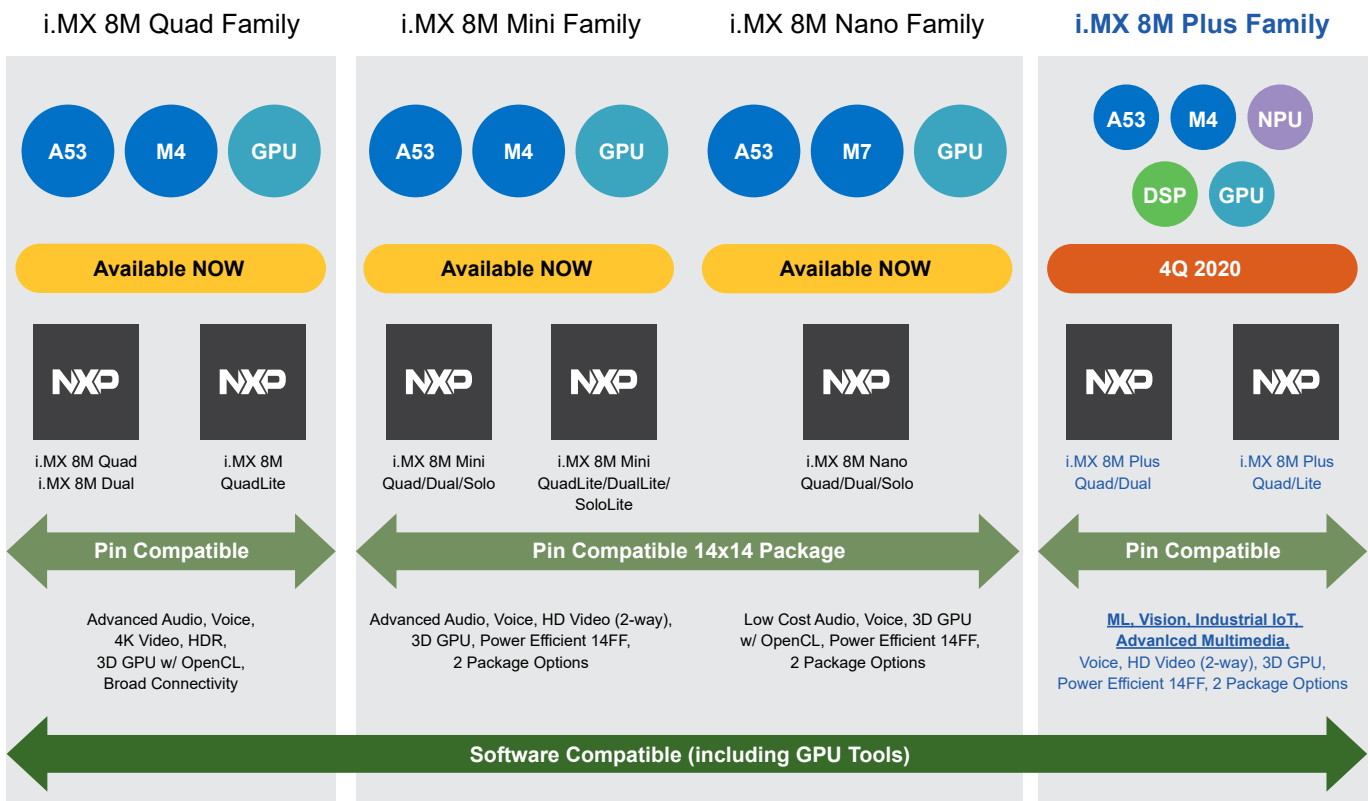

Scalable series of FOUR Arm V8 64-bit (/32-bit) based SoC Families

## » Machine Learning Acceleration at the Edge

### » AIOM-X8MM

- Computer on Module (32mm x 50 mm)
- i.MX8M Mini SoC

### » AIOM-X8MN

- Computer on Module (32mm x 50 mm)
- i.MX8M Nano SoC

### » AIOM-X8MP

- Computer on Module (32mm x 50 mm)
- i.MX8M Plus SoC

IEI's i.MX 8M computer on module series integrates with i.MX 8M mini, i.MX8M and i.MX8M plus SoCs.

The i.MX 8M Plus family of processors is based on ARM® Cortex®-A53 and Cortex-M7 cores and delivers a new level of:

- Machine Learning and Vision System
- Advanced Multimedia
- Industrial Networking and High Reliability.

It is well suited for applications as:

- Smart Home, Building, Retail and City
- Smart Factory and Industry IoT

