

IEI AI Ready Systems

Artificial Intelligence, AI, is changing our lives from the past to the future. It enables machine learning by using a variety of training models to simulate and infer the status or appearance of objects. For example, the inference system with the video analysis model can perform face and vehicle license plate analysis for safety and security purposes.

Today, most of AI technology still rely on the data center to execute the inference, which will increase the risk of real-time application for applications such as traffic monitoring, security CCTV, etc. Therefore, it's crucial to implement a low-latency, real-time edge computing platform. So IEI develop series of inference system for AI edge computing in different using environment.



» AI Deep Learning Work Flow

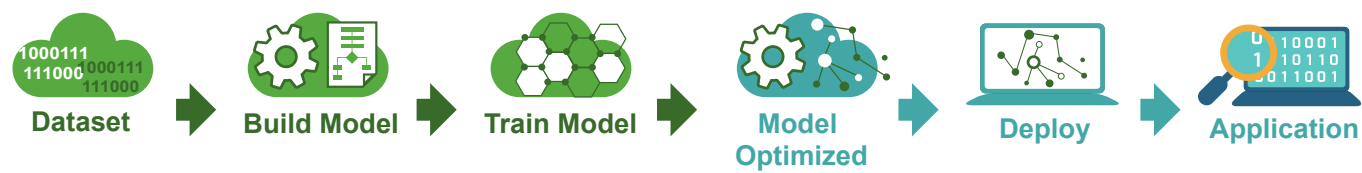

Training

ONNX mxnet TensorFlow Caffe

Inferencing

OpenVINO TensorFlow Lite TensorRT

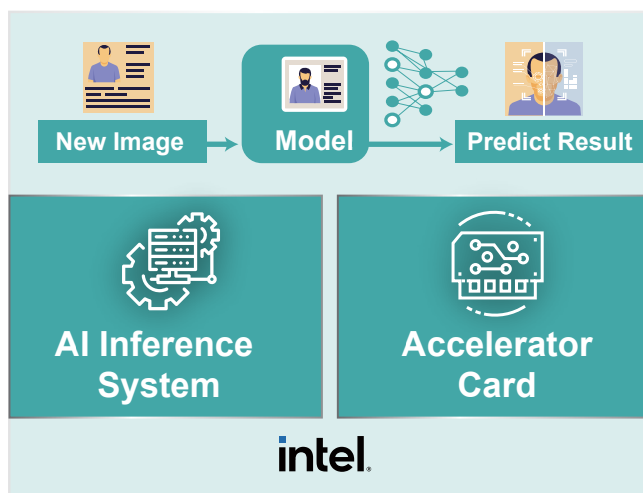
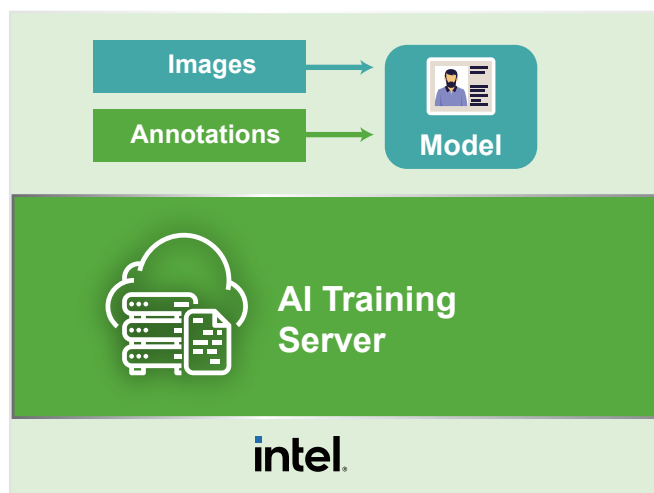

» ICI AI Inference System



Note :
Expansion
support

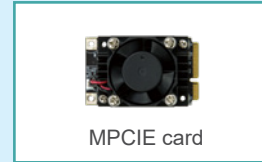
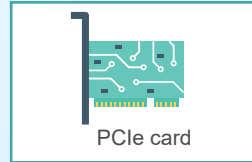

intel



TANK-XM811
AIoT Dev. kit
Intel® ADL-S AI Dev. Kit



intel



TANK-870
AIoT Dev. kit
Intel® SkyLake AI Dev. Kit



intel



FLEX-BX200
AIoT Dev. kit
Intel® Coffee Lake
Developer Kit



intel



FLEX-BX210AI-Q470
Intel® Comet Lake AI Box PC



intel



DRPC-230
Intel® Whisky Lake AI
Embedded System



intel



DRPC-240AI
Intel® Tiger Lake AI
Embedded System



intel



RACK-500AI
Intel® Coffee Lake AI Box
PC



intel



HTB-210-Q470
Intel® Comet Lake Medical
AI Box PC



AI Google Coral TPU Overview & Products



As an industrial PC / AI accelerator manufacturer, IEI provides excellent-performance AI accelerators to fulfill different AI tasks. Google Coral edge TPU provides up to 4TOPS, and its power consumption is only 2 watt per TPU module.

Google edge TPU leveraging well-developed Tensorflow Lite community can help you fast implement the existing model zoo to your edge inference project, from image classification, object detection to image segmentation.

Edge TPU Coral

- Google Edge TPU ML accelerator: 4 TOPS peak performance (int8) / 2 TOPS per watt
- Integrated power management
- PCIe Gen2 x1 or USB 2.0 interface
- Surface-mounted (LGA) module
- Size: 15.0 x 10.0 x 1.5 mm



» Mustang-T100-T5

IEI Mustang-T100-T5 leverages the power of Google Coral edge TPU. It integrates five Coral TPU modules into one half-height, half-length, single slot PCIe card, and can provide up to 20 TOPS. It is an ideal compact PCIe accelerator for multiple AI applications.



Feature

- 5 x Google Edge TPU ML accelerator
- 20 TOPS peak performance (int8)
- Host interface PCIe Gen2 x4
- Low-profile PCIe form factor
- Approximate 15W
- RoHS compliants

System Requirements

- Linux:
64-bit version of Debian 10 or Ubuntu 16.04 (or newer)
x86-64 or ARMv8 system architecture
- Windows:
64-bit version of Windows 10
x86-64 system architecture

Mustang-T100-T5 Block Diagram

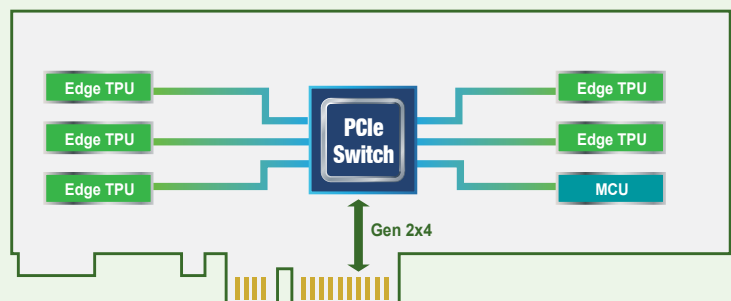

IEI provides series of system to support Mustang-T100-T5 accelerator such as TANK-870AI & FLEX-BX200AI.

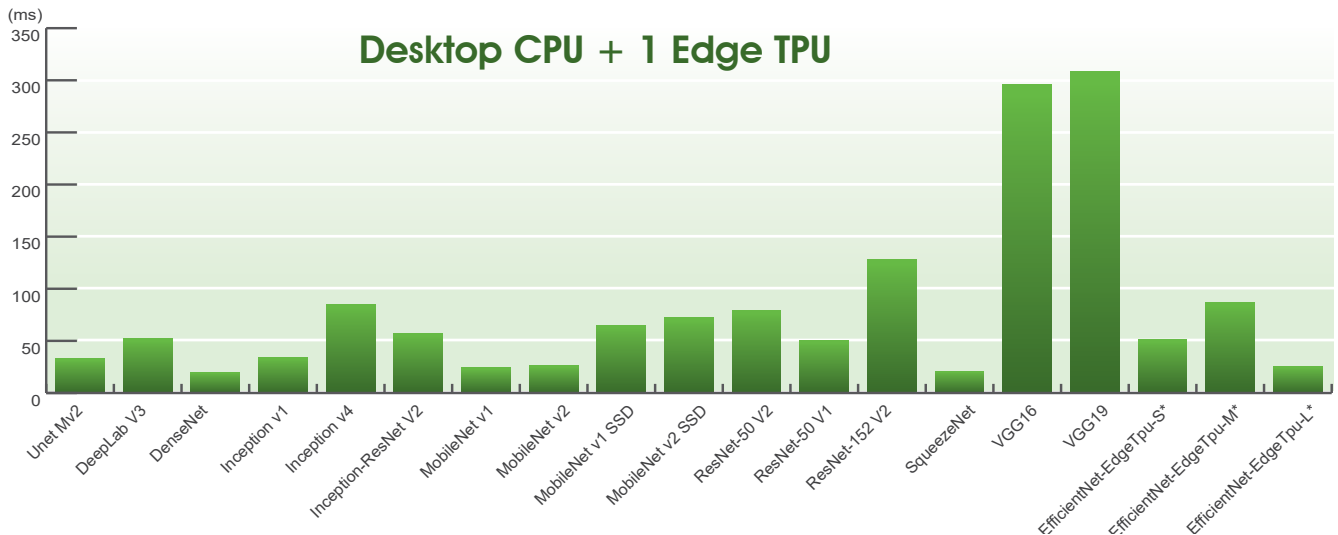

TensorFlow models on the Edge TPU - Coral

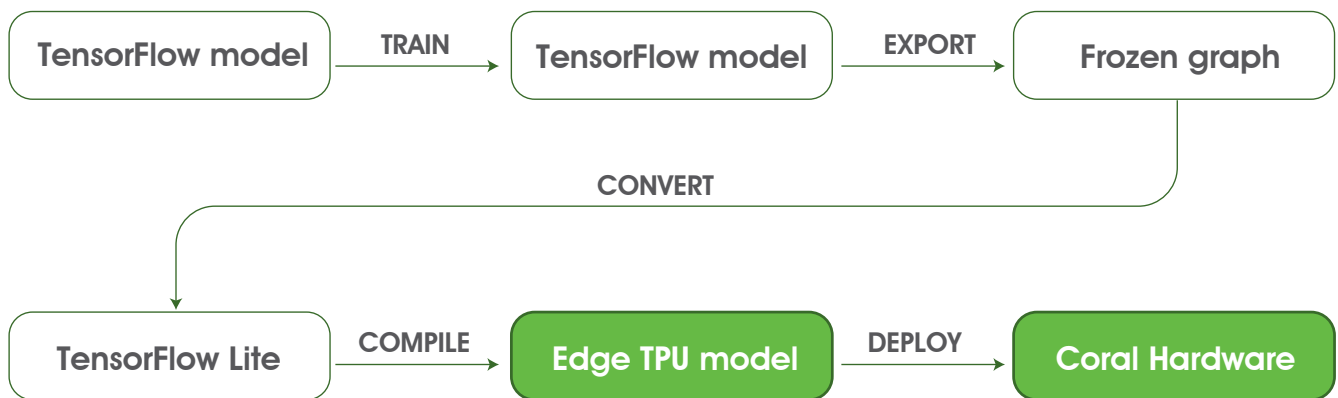

Solutions for on-device intelligence

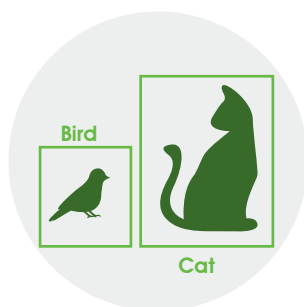

Object detection

Draw a square around the location of various recognized objects in an image



Pose estimation

Estimate the poses of people in an image by identifying various body joints.

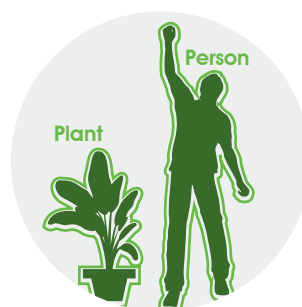

Image segmentation

Identify various objects in an image and their location on a pixel-by-pixel basis.



Key phrase detection

Listen to audio samples and quickly recognize known words and phrases.

Source: <https://coral.ai/>

IEI Accelerators with Intel® Solution



Interface	MX VPU x8	MX VPU x4	MX VPU x2	MX VPU x1
PCIe	Mustang-V100-MX8 Myriad X	Mustang-V100-MX4 Myriad X		
MPCIE			Mustang-MPCIE -MX2	
M.2			Mustang-M2BM -MX2, BM Key	Mustang-M2AE -MX1, AE Key

➔ Intel VPU

Intel® Movidius™ VPUs enable demanding computer vision and edge AI workloads with efficiency. By coupling highly parallel programmable compute with workload-specific hardware acceleration in a unique architecture that minimizes data movement, Movidius VPUs achieve a balance of power efficiency and compute performance. VPU technology enables intelligent cameras, edge servers and AI appliances with deep neural network and computer vision based applications in areas such as visual retail, security and safety, and industrial automation.

SoC Code Name	Gen2 VPU Myriad X
Embedded CPU	NA
Functions	Inference
Precision	FP16
Performance	1 TOPS per chip
Structure	

➤➤ Mustang Accelerator Card Family

Mustang-V100-MX8
Eight Intel® Movidius™ Myriad™ X MA2485 VPU

Mustang-V100-MX4
Four Intel® Movidius™ Myriad™ X MA2485 VPU

Mustang-M2AE-MX1
Intel® Movidius™ Myriad™ X MA2485 VPU

Mustang-M2BM-MX2
Two Intel® Movidius™ Myriad™ X MA2485 VPU

Mustang-MPCIE-MX2
Two Intel® Movidius™ Myriad™ X MA2485 VPU