

# Industrial Motherboard Selection Guide

Model Name	IMBA-Q370	IMBA-C2360-i2	IMBA-Q170-i2	IMBA-H110	IMBA-BDE
<b>CPU Socket</b>	LGA1151	LGA1151	LGA1151	LGA1151	On board
<b>CPU Type</b>	8th generation Intel® Core™ i7/i5/i3/Pentium® and Celeron® processor	Intel® Xeon® E3, Core™ i3, Pentium®, Celeron® processor	6th generation Intel® Core™ i7/ i5/i3 Pentium® and Celeron® processor	6th generation Intel® Core™ i7/ i5/i3, Celeron® and Pentium® processor	Intel® Xeon processor D-1500 product family
<b>Chipset</b>	Intel® Q370	Intel® C236	Intel® Q170	Intel® H110	Intel® Xeon processor D-1500 product family
<b>Memory</b>	Four 288-pin 2133 MHz dual-channel DDR4 SDRAM unbuffered DIMMs (systemMax. 64 GB)	Four 288-pin 2133 MHz dual-channel DDR4 SDRAM unbuffered DIMMs (system Max. 64 GB)	Four 288-pin 2133 MHz dual-channel DDR4 SDRAM unbuffered DIMMs (system Max. 64 GB)	Two 288-pin 2133 MHz dual-channel DDR4 SDRAM unbuffered DIMMs (system Max. 64 GB)	Four 288-pin 2133 MHz dual-channel DDR4 SDRAM unbuffered DIMMs (system max. 128 GB)
<b>Display Interface</b>	Triple independent display support 1 x HDMI 2.0 1 x DVI-I 1 x iDP interface	Triple independent display support 1 x HDMI 2.0 1 x DVI-D 1 x VGA 1 x iDP interface	Triple independent display support 1 x HDMI 2.0 1 x DVI-D 1 x VGA 1 x iDP interface	Dual independent display support 1 x DVI-I 1 x HDMI 1 x iDP interface	VGA via AST2510
<b>Ethernet</b>	LAN1: Intel® I210-AT PCIe controller with NCSI support LAN2: Intel® I219LM with Intel® AMT 11.0 support	LAN1: Intel® I219LM with Intel® AMT 11.0 support LAN2: Intel® I210-AT PCIe controller with NCSI support	LAN1: Intel® I219LM with Intel® AMT 11.0 support LAN2: Intel® I210-AT PCIe controller with NCSI support	LAN1: Intel® I219V PHY LAN2: Intel® I211 PCIe Controller	LAN1: Intel® I211-AT PCIe controller LAN2: Intel® I210-AT PCIe controller LAN3&4: Inphi CS4227 PHY (optional)
<b>iRIS Remote Management Module</b>	N/A	1 x iRIS-2400 slot	1 x iRIS-2400 slot	N/A	N/A
<b>I/O Interface</b>	1 x PS/2 KB/MS 1 x LPT 2 x RS-232/422/485 4 x RS-232 4 x USB 2.0 8 x USB 3.1	1 x KB/MS 1 x LPT 2 x RS-232/422/485 4 x RS-232 5 x USB 3.1 Gen 1 7 x USB 2.0	1 x KB/MS 1 x LPT 2 x RS-232/422/485 4 x RS-232 5 x USB 3.1 Gen 1 7 x USB 2.0	1 x KB/MS 1 x LPT 2 x RS-232/422/485 4 x RS-232 4 x USB 3.1 Gen 1 5 x USB 2.0	1 x PS/2 for KM/MS 1 x RS-232/422/485 1 x USB 2.0 Type A 4 x USB 3.1 Gen 1 5 x RS-232 6 x USB 2.0
<b>Storage Interface</b>	6 x SATA 6Gb/s (RAID 0/1/5/10 supported)	6 x SATA 6Gb/s (RAID 0/1/5/10 supported)	6 x SATA 6Gb/s (RAID 0/1/5/10 supported)	4 x SATA 6Gb/s	6 x SATA 6Gb/s
<b>Audio</b>	Realtek ALC662 HD Audio codec				
<b>Digital I/O</b>	8-bit programmable digital I/O	8-bit programmable I/O (8-bit GPIO is for programming I/O)			
<b>Power Consumption</b>	3.3V@1.65A, 5V@3.4A, 12V@8.58A, 5VSV@3.4A (Intel® Core® i7-8700K up to 4.60 GHz CPU with 32GB 2600MHz DDR4 memory)	3.3V@1.51A, 5V@3.31A, 12V@9.02A, 5VSB@3.7A (Intel® Xeon® E3-1275 v5 3.60 GHz CPU with 32 GB (four 8GB) 2133 MHz DDR4 memory)	3.3V@1.65A, 5V@3.4A, 12V@8.58A, 5VSB@3.4A (Intel® Core™ i7 6700K 4.0GHz CPU with 32 GB (Four 8 GB) 2133 MHz DDR4 memory)	3.3V@1.53A, 5V@2.95A, 12V@8.38A, 5VSB@3.2A (Intel® Core™ i7 6700K 4.0GHz CPU with 16GB (two 8GB) 2133 MHz DDR4 memory)	3.3V@0.11A, 5V@2.83A, 12V@3.97A (Intel® Xeon D-1548 2.0GHz CPU with 32GB (four 4 GB) 2133MHz DDR4 memory)
<b>Watchdog Timer</b>	Software programmable and supports 1~255 sec. system reset				
<b>Operation Environment</b>	Temperature Range: -20°C ~ 60°C (-4°F ~ 140°F) Relative Humidity: 5% ~ 95%, non-condensing				Temperature Range: 0°C ~ 60°C (32°F ~ 140°F) Relative Humidity: 10% ~ 95%, non-condensing
<b>Expansion Slot</b>	1 x Full-size PCIe Mini card slot (support mSATA) 1 x M.2 (A key) 1 x M.2 (M Key) 1 x PCIe x16 (Gen3) (share x16 signal with 1 x8 & 1 x4 slot) 1 x PCIe x8 (Gen3) 2 x PCIe x4 (Gen3) 2 x PCI slot	1 x Full-size PCIe Mini card slot (support mSATA) 2 x PCIe x8 (Gen3) 3 x PCIe x4 (Gen3) 2 x PCI slot	1 x Full-size PCIe Mini card slot (support mSATA) 2 x PCIe x8 (Gen3) 3 x PCIe x4 (Gen3) 2 x PCI slot	1 x Full-size PCIe Mini card slot (support mSATA) 1 x PCIe x16 slot (Gen3) 6 x PCI slot	1 x M.2 connector (M key) 1 x PCIe x4 slot (for 10GbE LAN card only) 5 x PCIe x4 Gen3 1 x PCIe x4 Gen2
<b>CPU Cooler</b>	CF-115XA-R10 CF-1156C-R20 CF-1156D-R20 CF-115XE-R10	CF-115XA-R10 CF-1156C-R20 CF-1156D-R20 CF-115XE-R10	CF-115XA-R10 CF-1156C-R20 CF-1156D-R20 CF-115XE-R10	CF-115XA-R10 CF-1156C-R20 CF-1156D-R20 CF-115XE-R10	XCF-989A-RS-R12

# Industrial Motherboard Selection Guide

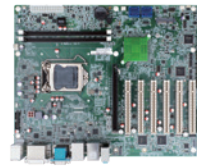
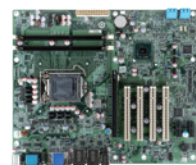
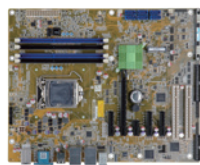
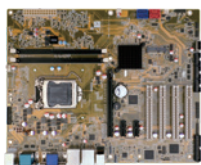

Model Name	IMBA-H810	IMBA-C2260-i2-R11	IMBA-Q870-i2	IMBA-H610	IMBA-Q670-R30
<b>CPU Socket</b>	LGA1150	LGA1150	LGA1150	LGA1155	LGA1155
<b>CPU Type</b>	4th generation Intel® Core™ i7/ i5/i3 Pentium® and Celeron® processor	Intel® Xeon® E3, Core™ i3, Pentium®, Celeron® processor	Intel® Core™ i7/i5/i3, Pentium®, Celeron® processor	Intel® Core™ i7/i5/i3, Pentium®, Celeron® processor	Intel® Core™ i7/i5/i3, Pentium® Dual, Celeron® processor
<b>Chipset</b>	Intel®H81	Intel® C226	Intel® Q87	Intel® H61	Intel® Q67
<b>Memory</b>	Two 240-pin 1333/1600 MHz dual-channel DDR3 SDRAM unbuffered DIMM (system max. 16 GB)	Four 240-pin 1600/1333 MHz dual-channel DDR3 & DDR3L SDRAM ECC and non-ECC unbuffered DIMMs (system max. 32 GB)	Four 240-pin 1600/1333 MHz dual-channel DDR3 & DDR3L SDRAM unbuffered DIMMs (system max. 32 GB)	Two 240-pin 1333/1066 MHz dual-channel DDR3 SDRAM DIMM (system max. 16 GB)	Four 240-pin 1333/1066 MHz dual-channel DDR3 SDRAM unbuffered DIMM (system max. 32 GB)
<b>Display Interface</b>	Dual independent display support 1 x DVI-D 1 x VGA 1 x iDP interface	Dual display supported 1 x VGA 1 x iDP interface	Triple display supported 1 x VGA 1 x DVI-D 1 x HDMI 1 x iDP interface	Dual display supported 1 x VGA 1 x DVI-D	Dual display supported 1 x VGA 1 x HDMI 1 x DVI-D
<b>Ethernet</b>	LAN1: Intel® I217-LM with Intel® AMT 9.0 support LAN2: Intel® I211-AT PCIe controller	LAN1: Intel® I217LM with Intel® AMT 9.0 support LAN2: Intel® I210-AT PCIe controller with NCSI support	LAN1: Intel® I217LM with Intel® AMT 9.0 support LAN2: Intel® I210-AT PCIe controller with NCSI support	LAN1: Realtek RTL8111E PCIe GbE controller with ASF 2.0 support LAN2: Realtek RTL8111E PCIe GbE controller	LAN1: Intel® 82583V PCIe controller LAN2: Intel® 82579 PHY with Intel® AMT 7.0 support
<b>iRIS Remote Management Module</b>	N/A	1 x iRIS-2400 slot	1 x iRIS-2400 slot	N/A	N/A
<b>I/O Interface</b>	1 x IR 1 x PS/2 for KB/MS 1 x RS-232/422/485 1 x USB 2.0 Type A 2 x USB 3.1 Gen 1 5 x RS-232 6 x USB 2.0	1 x LPT 1 x PS/2 for KB/MS 1 x RS-422/485 4 x USB 3.1 Gen 1 5 x RS-232 8 x USB 2.0	1 x LPT 1 x PS/2 for KB/MS 1 x RS-422/485 4 x USB 3.1 Gen 1 5 x RS-232 8 x USB 2.0	1 x iPC 1 x LPT 1 x PS/2 for KB/MS 1 x RS-422/485 1 x SMBus 1 x TPM (2x10 pin) 5 x RS-232 10 x USB 2.0	1 x iPC 1 x LPT 1 x PS/2 KB & MS 1 x RS-422/485 1 x SMBus 1 x TPM (2x10 pin) 2 x USB 3.1 Gen 1 5 x RS-232 10 x USB 2.0
<b>Storage Interface</b>	2 x SATA 3Gb/s 2 x SATA 6Gb/s	6 x SATA 6Gb/s (RAID 0/1/5/10 supported) 1 x mSATA (colay SATA port 6) (support SATA 6Gb/s signal only)	6 x SATA 6Gb/s (RAID 0/1/5/10 supported) 1 x mSATA (colay SATA port 6) (support SATA 6Gb/s signal only)	4 x SATA 3Gb/s	2 x SATA 6Gb/s 4 x SATA 3Gb/s
<b>Audio</b>	Realtek ALC662 HD Audio codec			Realtek ALC892 HD Audio codec	Realtek ALC662 HD Audio codec
<b>Digital I/O</b>	8-bit programmable I/O (8-bit GPIO is for programming I/O)			8-bit digital I/O (4-bit input/4-bit output)	
<b>Power Consumption</b>	3.3V@0.83A, 5V@2.2A, 12V@3.88A, 5VSB@0.3A (Intel® Core™ i7-4770K 3.90 GHz CPU with 8 GB (two 4 GB) 1333 MHz DDR3 memory)	3.3V@0.57A, 5V@4.50A, 12V@0.14A, Vcore_12V@5.20A, 5VSB@0.19A (Intel® E3-1240 v3 3.4GHz CPU with 16 GB (four 4 GB) 1333 MHz DDR3 memory)	3.3V@0.66A, 5V@4.34A, 12V@0.16A, Vcore_12V@4.01A, 5VSB@0.21A (Intel® Core™ i7-4770K 3.90 GHz CPU with four 1333 MHz 4 GB DDR3 DDR3 memory)	3.3V@1.27A, 5V@3.87A, 12V@0.54A, Vcore@7.67A, 5VSB@0.15A (Intel® Core™ i7-2600K 3.40GHz CPU with two 1333 MHz 2 GB DDR3 Memory)	3.3V@1.65A, 5V@6.31A, 12V@0.18A, Vcore@7.88A, 5VSB@0.15A (Intel® Core™ i5-2400 3.10GHz CPU with four 1333 MHz 4 GB DDR3 memory)
<b>Watchdog Timer</b>	Software programmable and supports 1~255 sec. system reset				
<b>Operation Environment</b>	Temperature Range: -20°C ~ 60°C (-4°F ~ 140°F) Relative Humidity: 5% ~ 95%, non-condensing	Temperature Range: -10°C ~ 60°C (14°F ~ 140°F) Relative Humidity: 5% ~ 95%, non-condensing			
<b>Expansion Slot</b>	1 x PCIe x16 2 x PCIe x1 4 x PCI 1 x PCIe Mini (support mSATA)	1 x PCIe x16 slot 3 x PCIe x4 slot Default setting: 1 x PCIe x8, 2 x PCIe x4 Optional setting: 1 x PCIe x16 by BIOS setting 1 x PCIe x1 slot 2 x PCI slot	1 x PCIe x16 slot (Gen 3) 1 x PCIe x4 slot 1 x PCIe x1 slot 4 x PCI slots	1 x PCIe x16 2 x PCIe x1 4 x PCI	1 x PCIe x16 1 x PCIe x4 1 x PCIe x1 4 x PCI
<b>CPU Cooler</b>	CF-115XA-R10 CF-115XE-R10	CF-115XA-R10 CF-115XE-R10	CF-115XA-R10 CF-115XE-R10	CF-115XA-R10 (for 1U chassis) CF-1156C-R20 CF-1156D-R20 CF-115XE-R10	CF-115XA-R10 (for 1U chassis) CF-1156C-R20 CF-1156D-R20 CF-115XE-R10

# Industrial Motherboard Selection Guide

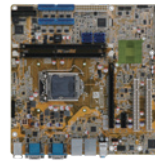

Model Name	IMB-H110	IMB-Q870-i2	IMB-H810-i2-R11	IMB-H610
<b>CPU Socket</b>	LGA1151	LGA1150	LGA1150	LGA1155
<b>CPU Type</b>	6th generation Intel® Core™ i7/i5/i3, Celeron® and Pentium® processor	Intel® Core™ i7/i5/i3, Pentium®, Celeron® processor	Intel® Core™ i7/i5/i3, Pentium®, Celeron® processor	Intel® Core™ i7/i5/i3, Pentium®, Celeron® processor
<b>Chipset</b>	Intel® H110	Intel® Q87	Intel® H81	Intel® H61
<b>Memory</b>	Two 288-pin 2133MHz Dual-Channel DDR4 SDRAM Unbuffered DIMM supported up to 64GB	Four 240-pin 1600/1333 MHz dual-channel DDR3 & DDR3L SDRAM unbuffered DIMMs (system max. 32 GB)	Two 240-pin 1600/1333 MHz dual-channel DDR3 & DDR3L SDRAM unbuffered DIMMs (system max. 32 GB)	Two 240-pin 1333/1066 MHz dual-channel DDR3 SDRAM unbuffered DIMM supported (system max. 16 GB)
<b>Display Interface</b>	Dual independent display support 1 x VGA 1 x DVI-I 1 x LVDS 1 x iDP	Triple display supported 1 x VGA 1 x DVI-D 1 x HDMI 1 x iDP interface	Triple display supported 1 x VGA1 1 x VGA2 1 x iDP interface	Dual display supported 1 x VGA (up to 2048x1536@75Hz) 1 x DVI-D (up to 1920x1200@60Hz)
<b>Ethernet</b>	Dual LAN: RTL 8111GN controller	LAN1: Intel® I217LM with Intel® AMT 9.0 support LAN2: Intel® I210-AT PCIe controller with NCSI support	LAN1: Intel® I217LM LAN2: Intel® I210-AT PCIe controller with NCSI support	LAN1: Realtek RTL8111E PCIe GbE controller with ASF 2.0 support LAN2: Realtek RTL8111E PCIe GbE controller
<b>iRIS Remote Management Module</b>	N/A	1 x iRIS-2400 slot		N/A
<b>I/O Interface</b>	1 x KB/MS 1 x LPT 2 x RS-232/422/485 4 x USB 3.1 Gen 1 8 x USB 2.0 10 x RS-232	1 x PS/2 for KB/MS 1 x RS-422/485 4 x USB 3.1 Gen 1 5 x RS-232 8 x USB 2.0	1 x LPT 1 x PS/2 for KB/MS 1 x RS-422/485 by s/w selection 2 x RS-232 2 x USB 3.1 Gen 1 8 x RS-232 10 x USB 2.0	1 x iFC 1 x PS/2 KB/MS 1 x RS-422/485 1 x SMBus 1 x TPM (2x10 pin) 5 x RS-232 (for IMB-H610A/ IMB-H612A) 9 x RS-232 (for IMB-H610B/ IMB-H612B) 10 x USB 2.0
<b>Storage Interface</b>	4 x SATA 6Gb/s (RAID 0/1 supported)	4 x SATA 6Gb/s (RAID 0/1/5/10 supported)	2 x SATA 6Gb/s 2 x SATA 3Gb/s (AHCI supported)	4 x SATA 3Gb/s
<b>Audio</b>	Realtek ALC662 HD Audio codec			
<b>Digital I/O</b>	8-bit programmable digital I/O	8-bit programmable I/O (8-bit GPIO is for programming I/O)	N/A	8-bit digital I/O (4-bit input/4-bit output)
<b>Power Consumption</b>	3.3V@ 0.93A, 5V@2.99A, 12V@6.88A, 5VSB@0.02A (Intel® Core™ i7-6700K 4.0GHz CPU with 16GB (two 8GB) 2133 MHz DDR4 memory)	3.3V@0.53A, 5V@4.96A, 12V@0.12A, Vcore_12V@3.95A, 5VSB@0.18A (Intel® Core™ i7-4770K 3.90 GHz CPU with 16 GB four 1333 MHz 4 GB DDR3 memory)	3.3V@0.64A, 5V@4.20A, 12V@0.14A, Vcore_12V@3.88A, 5VSB@0.20A (Intel® Core™ i7-4770K 3.90 GHz CPU with 8 GB two 1333 MHz 4 GB DDR3 memory)	3.3V@1.75A, 5V@6.61A, Vcore@3.68A, 12V@0.09A, 5sb@0.12A (Intel® 2.60GHz CPU with four 1333 MHz 4 GB DDR3 memory)
<b>Watchdog Timer</b>	Software programmable and supports 1~255 sec. system reset			
<b>Operation Environment</b>	Temperature Range: -20°C ~ 60°C (-4°F~140°F) Relative Humidity: 5% ~ 95% non-condensing			Temperature Range: -10°C ~ 60°C (14°F~140°F) Relative Humidity: 5% ~ 95%, non-condensing
<b>Expansion Slot</b>	1 x PCIe x16 slot (Gen3) 1 x Full-size PCIe Mini card slot 1 x PCIe x1 slot (Gen2) 2 x PCI slot	1 x PCIe x16 slot (Gen 3) 1 x PCIe x4 slot 1 x PCIe x1 slot 1 x PCI slot	1 x PCIe x16 slot (Gen 3) 1 x PCIe x1 slot 2 x PCI slot	1 x PCIe x 16 3 x PCIe x 1
<b>CPU Cooler</b>	CF-115XA-R10 CF-115XE-R10	CF-115XA-R10 CF-115XE-R10		CF-115XA-R10 (for 1U chassis) CF-1156C-R20 CF-1156D-R20 CF-115XE-R10





# IMBA-C2360-i2

ATX motherboard supports 14nm LGA1151 Intel® Xeon® E3 v5 series, Core™ i3, Pentium®, Celeron® processor per Intel® C236, DDR4, triple independent display, HDMI 2.0, dual Intel® PCIe GbE, USB 3.1 Gen 1 (5Gb/s), SATA 6Gb/s, HD Audio, IPMI 2.0 and RoHS

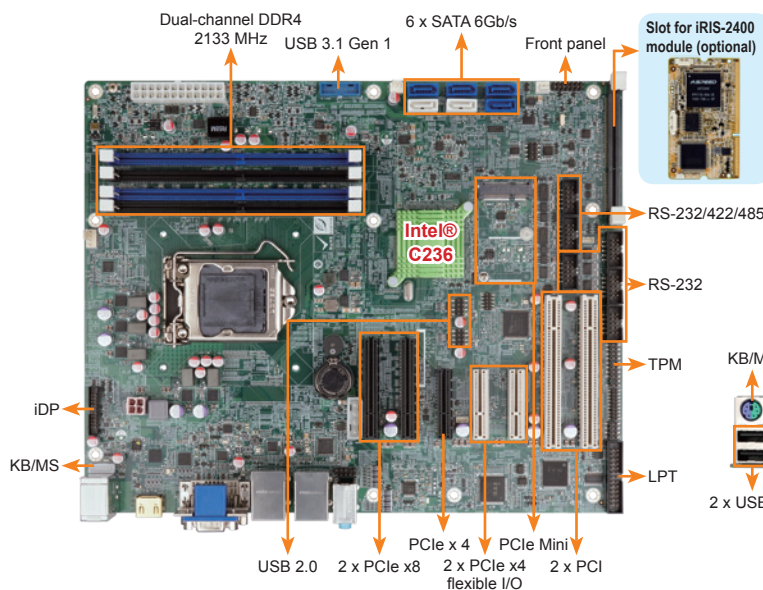

## Dual BIOS (for flexible I/O only)

Easy for customer to switch different ME firmware to achieve I/O flexibility

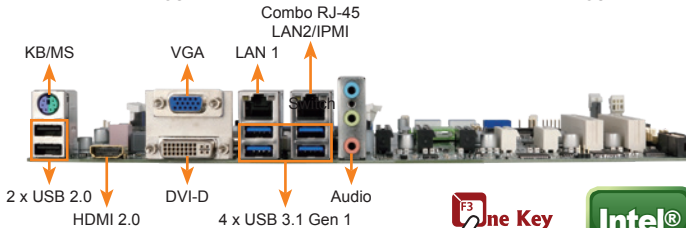
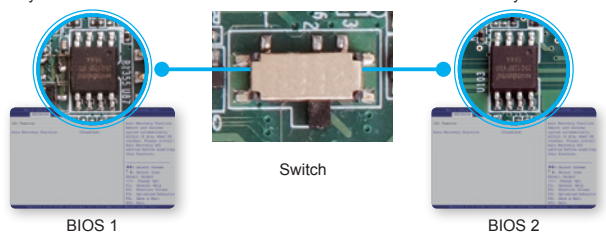

## Specifications

- ◆ CPU  
LGA 1151 socket supports Intel® Xeon® E3 v5/v6, 6th/7th generation Core™ i3, Pentium® or Celeron® processor
- ◆ Chipset  
Intel® C236
- ◆ Memory  
Four 288-pin 2133 MHz dual-channel DDR4 SDRAM ECC and non-ECC unbuffered DIMMs support up to 64 GB
- ◆ BIOS  
UEFI BIOS
- ◆ Graphics Engine  
Intel® HD Graphics Gen 9 engine with 16 low-power execution units, supports DX11/12, OpenGL 4.3/4.4 and OpenCL2.x, ES 2.0
- ◆ Display Output  
Triple independent display  
1 x VGA (up to 1920x1200@60Hz)  
1 x DVI-D (up to 1920x1200@60Hz)  
1 x HDMI 2.0 (up to 4096x2160@60Hz)  
1 x iDP interface for HDMI, LVDS, VGA, DVI, DP (up to 3840x2160@60Hz)
- ◆ Ethernet  
LAN1: Intel® I219LM with Intel® AMT 11.0 support  
LAN2: Intel® I210AT PCIe controller with NCSI support
- ◆ External I/O Interface  
2 x USB 2.0  
4 x USB 3.1 Gen 1 (5Gb/s)
- ◆ Internal I/O Interface  
1 x KB/MS (1x6 pin)  
1 x LPT (2x13 pin, P=2.54)  
2 x USB 3.1 Gen 1 (5Gb/s) (2x10 pin, P=2.0)  
2 x RS-232/422/485 (2x5 pin, P=2.54)  
4 x RS-232 (2x5 pin, P=2.54)  
4 x USB 2.0 (2x4 pin, P=2.0)  
6 x SATA 6Gb/s
- ◆ SMBus: 1 x SMBus (1x4 pin)
- ◆ I<sup>2</sup>C: 1 x I<sup>2</sup>C (1x4 pin)
- ◆ TPM: 1 x TPM (2x10 pin)
- ◆ Audio  
Realtek ALC662 HD codec supports 5.1-channel  
3 x Audio jacks (line-out, line-in, mic-in) on rear IO  
1 x Front audio (2x5 pin)
- ◆ Front Panel  
1 x Front panel (2x7 pin, power LED, HDD LED, speaker, power button, reset button)
- ◆ LAN LED: 2 x LAN LED (1x2 pin)
- ◆ Expansion  
1 x Full-size PCIe Mini card slot (support mSATA) 2 x PCIe x8 slot (Gen3)  
2 x PCI slot 3 x PCIe x4 slot (Gen3)
- ◆ iRIS Remote Management Module: 1 x iRIS-2400 slot
- ◆ Watchdog Timer: Software programmable supports 1~255 sec. system reset
- ◆ Digital I/O: 8-bit digital I/O (2x5 pin)
- ◆ Fan Connector  
1 x CPU smart fan (1x4 pin)  
2 x System smart fan (1x3 pin)
- ◆ Power Supply: ATX/AT power supply
- ◆ Power Consumption  
3.3V@1.51A, 5V@3.31A, 12V@9.02A, 5VSB@3.7A (Intel® Xeon® E3-1275 v5 3.60 GHz CPU with 32 GB (four 8GB) 2133 MHz DDR4 memory)
- ◆ Operating Temperature: -20°C ~ 60°C
- ◆ Storage Temperature: -30°C ~ 70°C
- ◆ Operating Humidity: 5% ~ 95%, non-condensing
- ◆ Dimensions: 244mm x 305mm
- ◆ Weight: GW: 1200g / NW: 700g
- ◆ CE/FCC compliant



## Features

- LGA 1151 Intel® Xeon® E3 v5/v6, 6th/7th generation Core™ i3, Pentium® or Celeron® processor supported
- Dual-channel DDR4 2133 MHz
- Intel® PCIe GbE with Intel® AMT11.0 support
- Support independent triple display with HDMI, DVI and VGA
- Support PCI Express generation 3.0 at 8GT/s I/O bandwidth
- USB 3.1 Gen 1 (5Gb/s) and SATA 6Gb/s
- Support IPMI 2.0 via iRIS-2400
- IEI One Key Recovery solution allows you to create rapid OS backup and recovery

## Packing List

1 x IMBA-C2360-i2 single board computer	2 x SATA cable
1 x I/O shielding	1 x QIG

## Ordering Information

Part No.	Description
IMBA-C2360-i2-R10	ATX motherboard supports 14nm LGA1151 Intel® Xeon® E3 v5 series, Core™ i3, Pentium®, Celeron® processor per Intel® C236, DDR4, triple independent display VGA/DVI-D/HDMI 2.0, dual Intel® PCIe GbE, USB 3.1 Gen 1 (5Gb/s), SATA 6Gb/s, HD Audio, IPMI 2.0 and RoHS
iRIS-2400-R10	IPMI 2.0 adapter card with AST2400 BMC chip for DDR3 SO-DIMM socket interface
PCIES-2PIMSATA-R10	Peripheral card for flexible I/O, 1 x PCIe Mini, 2 x mSATA expansion
PCIES-USB3-R10	Peripheral card for flexible I/O, USB 3.1 Gen 1 (5Gb/s) expansion
19800-000075-RS	PS/2 KB/MS cable with bracket, 220mm, P=2.0
19800-003100-100-RS	Dual port USB cable with bracket, 30mm, P=2.54
19800-010500-200-RS	USB 3.1 Gen 1 (5Gb/s) cable with bracket, 457mm
32102-000100-200-RS	SATA power cable, MOLEX 5264-4P to SATA15P
CF-1156C-R20	LGA1155/LGA1156 cooler kit, 1U chassis compatible, 45W
CF-1156D-R20	LGA1155/LGA1156 cooler kit, 1U chassis compatible, 65W
CF-115XE-R10	High performance LGA1155/LGA1156 cooler kit, 95W
DP-DP-R10	DisplayPort to DisplayPort converter board (for IEI iDP connector)
DP-DVI-R10	DisplayPort to DVI-D converter board (for IEI iDP connector)
DP-HDMI-R10	DisplayPort to HDMI converter board (for IEI iDP connector)
DP-LVDS-R10	DisplayPort to 24-bit dual-channel LVDS converter board (for IEI iDP connector)
DP-VGA-R10	DisplayPort to VGA converter board (for IEI iDP connector)
TPM-IN02-R20	20-pin Infineon TPM 2.0 module, software management tool, firmware v5.5

# IMBA-Q170-i2

ATX motherboard supports 14nm LGA1151 Intel® CPU, Intel® Q170, DDR4, triple independent display VGA/ DVI-D/ HDMI 2.0, dual Intel® PCIe GbE, USB 3.1 Gen 1 (5Gb/s), SATA 6Gb/s, HD Audio, IPMI 2.0 and RoHS

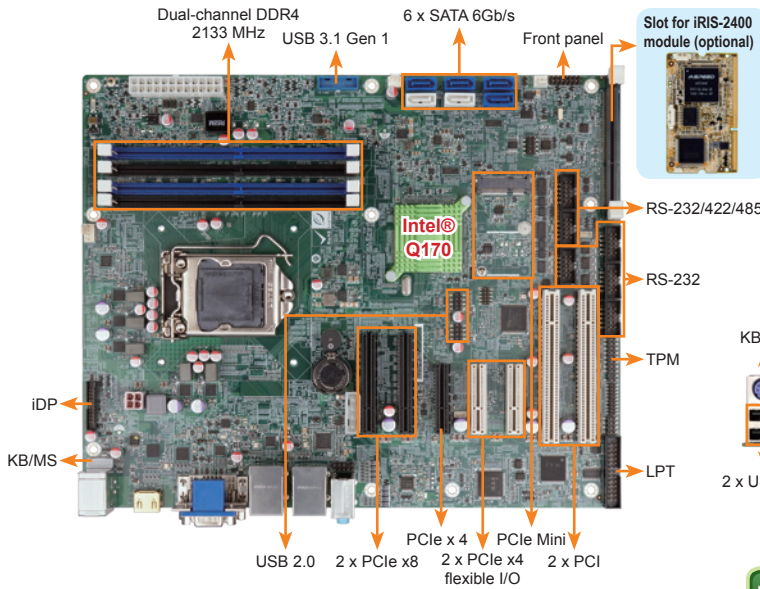

## Flexible I/O support

IEI USB 3.1 Gen 1 (5Gb/s) & mSATA/PCIe Mini expansion card  
The expansion card can provide more choices to meet users demand

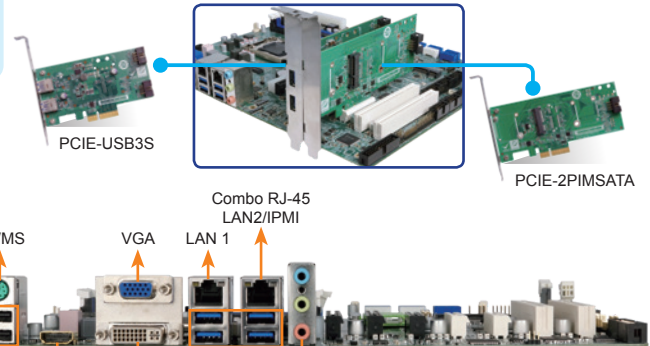

## Specifications

- ◆ CPU  
LGA 1151 socket supports Intel® 6th/7th generation Core™ i7/i5/i3, Pentium® or Celeron® processor
- ◆ Chipset  
Intel® Q170
- ◆ Memory  
Four 288-pin 2133 MHz dual-channel DDR4 SDRAM unbuffered DIMMs support up to 64 GB
- ◆ BIOS: UEFI BIOS
- ◆ Graphics Engine  
Intel® HD Graphics Gen 9 engine with 16 low-power execution units, supports DX11/12, OpenGL 4.3/4.4 and OpenCL2.x, ES 2.0
- ◆ Display Output  
Triple independent display  
1 x VGA (up to 1920x1200@60 Hz)  
1 x DVI-D (up to 1920x1200@60Hz)  
1 x HDMI 2.0 (up to 4096x2160@60Hz)  
1 x iDP interface for HDMI, LVDS, VGA, DVI, DP (up to 3840x2160@60Hz)
- ◆ Ethernet  
LAN1: Intel® I219LM with Intel® AMT 11.0 support  
LAN2: Intel® I210AT PCIe controller with NCSI support
- ◆ External I/O Interface  
2 x USB 2.0  
4 x USB 3.1 Gen 1 (5Gb/s)
- ◆ Internal I/O Interface  
1 x KB/MS (1x6 pin) 4 x RS-232 (2x5 pin, P=2.54)  
1 x LPT (2x13 pin, P=2.54) 4 x USB 2.0 (2x4 pin, P=2.0)  
2 x USB 3.1 Gen 1 (5Gb/s) (2x10 pin, P=2.0) 6 x SATA 6Gb/s (RAID 0/1/5/10 supported)  
2 x RS-232/422/485 (2x5 pin, P=2.54)
- ◆ SMBus: 1 x SMBus (1x4 pin)
- ◆ I<sup>2</sup>C: 1 x I<sup>2</sup>C (1x4 pin)
- ◆ TPM: 1 x TPM (2x10 pin)
- ◆ Audio  
Realtek ALC662 HD codec supports 5.1-channel  
3 x Audio jacks (line-out, line-in, mic-in) on rear IO  
1 x Front audio (2x5 pin)
- ◆ Front Panel  
1 x Front panel (2x7 pin, power LED, HDD LED, speaker, power button, reset button)
- ◆ LAN LED: 2 x LAN LED (1x2 pin)
- ◆ Expansion  
1 x Full-size PCIe Mini card slot (support mSATA)  
2 x PCI slot  
2 x PCIe x 8 slot (Gen3)  
3 x PCIe x 4 slot (Gen3)
- ◆ iRIS Remote Management Module: 1 x iRIS-2400 slot
- ◆ Watchdog Timer: Software programmable supports 1~255 sec. system reset
- ◆ Digital I/O: 8-bit digital I/O (2x5 pin)
- ◆ Fan Connector  
1 x CPU smart fan (1x4 pin)  
2 x System smart fan (1x3 pin)
- ◆ Chassis Open: 1 x Chassis intrusion (1x2 pin)
- ◆ Power Supply: ATX/AT power supply
- ◆ Power Consumption  
3.3V@1.65A, 5V@3.4A, 12V@8.58A, 5VSB@3.4A  
(Intel® Core™ i7 6700K 4.0GHz CPU with 32 GB (four 4 GB) 2133 MHz DDR4 memory)
- ◆ Operating Temperature: -20°C ~ 60°C
- ◆ Storage Temperature: -30°C ~ 70°C
- ◆ Operating Humidity: 5% ~ 95%, non-condensing
- ◆ Dimensions: 244mm x 305mm
- ◆ Weight: GW: 1200g / NW: 700g
- ◆ CE/FCC compliant



## Features

- LGA 1151 Intel® 6th/7th generation Core™ i7/i5/i3, Pentium® or Celeron® processor supported
- Dual-channel DDR4 2133 MHz
- Support triple display with HDMI, DVI and VGA
- Support USB 3.1 Gen 1 (5Gb/s), SATA 6Gb/s and PCI Express Gen3
- Support IPMI 2.0 via iRIS-2400 module
- IEI One Key Recovery solution allows you to create rapid OS backup and recovery

## Packing List

1 x IMBA-Q170-i2 single board computer	2 x SATA cable
1 x I/O shielding	1 x QIG

## Ordering Information

Part No.	Description
IMBA-Q170-i2-R10	ATX motherboard supports 14nm LGA1151 Intel® CPU, Intel® Q170, DDR4, triple independent display VGA/ DVI-D/ HDMI 2.0, dual Intel® PCIe GbE, USB 3.1 Gen 1 (5Gb/s), SATA 6Gb/s, HD Audio, IPMI 2.0 and RoHS
IMBA-Q170-ECO-R10	ATX motherboard supports 14nm LGA1151 Intel® CPU, Intel® Q170, DDR4, triple independent display VGA/ DVI-D/ HDMI 2.0, dual Intel® PCIe GbE, USB 3.1 Gen 1 (5Gb/s), SATA 6Gb/s, HD Audio, ECO packing and RoHS
iRIS-2400-R10	IPMI 2.0 adapter card with AST2400 BMC chip for DDR3 SO-DIMM socket interface
PCIES-2PIMSATA-R10	Peripheral card for flexible I/O, 1 x PCIe Mini, 2 x mSATA expansion
PCIES-USB3-R10	Peripheral card for flexible I/O, USB 3.1 Gen 1 (5Gb/s) expansion
19800-000049-RS	LPT flat cable, 240mm, P=2.54
19800-000075-RS	PS/2 KB/MS cable with bracket, 220mm, P=2.0
19800-003100-100-RS	Dual port USB cable with bracket, 30mm, P=2.54
19800-010500-200-RS	USB 3.1 Gen 1 (5Gb/s) cable 457mm with bracket
32102-000100-200-RS	SATA power cable, MOLEX 5264-4P to SATA15P
32205-000702-100-RS	RS-232 cable, 230mm, P=2.54
CF-1156C-R20	LGA1155/LGA1156 cooler kit, 1U chassis compatible, 45W
CF-1156D-R20	LGA1155/LGA1156 cooler kit, 1U chassis compatible, 65W
CF-115XE-R10	High-performance LGA1155/1156 cooler kit, 95W
DP-DP-R10	DisplayPort to DisplayPort converter board (for IEI iDP connector)
DP-DVI-R10	DisplayPort to DVI-D converter board (for IEI iDP connector)
DP-HDMI-R10	DisplayPort to HDMI converter board (for IEI iDP connector)
DP-LVDS-R10	DisplayPort to 24-bit dual-channel LVDS converter board (for IEI iDP connector)
DP-VGA-R10	DisplayPort to VGA converter board (for IEI iDP connector)
TPM-IN02-R20	20-pin Infineon TPM 2.0 module, software management tool, firmware v5.5





# IMBA-BDE

ATX motherboard supports 14nm Intel® Xeon® D1500 family, DDR4, VGA, dual Intel® GbE, dual 10GbE, four USB 3.1 Gen 1 (5Gb/s), six SATA 6Gb/s, HD Audio, and RoHS

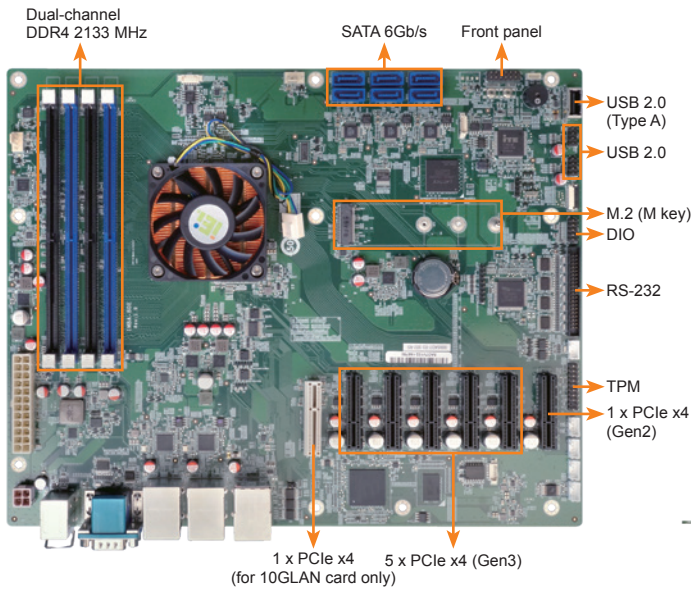

## High-speed 10GbE Add-on Card Support

### Integrated 10GbE LAN Interface

10GbE LAN card meets customer demand for high-speed internet

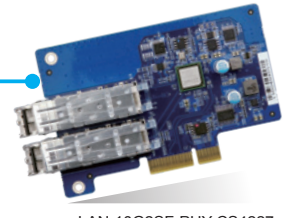
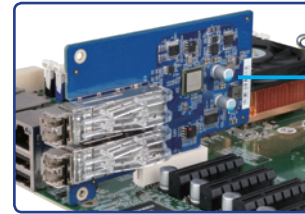

LAN-10G2SF-PHY-CS4227



## Specifications

- ◆ SoC
  - Intel® Xeon® processor D-1500 product family
  - Intel® Xeon® processor D-1548 (up to 8-core, 12M cache, TDP=45W)
  - Intel® Xeon® processor D-1518 (up to 4-core, 6M cache, TDP=35W)
- ◆ Memory
  - Four 288-pin 2133 MHz dual-channel DDR4 SDRAM unbuffered DIMMs support up to 128 GB
- ◆ BIOS
  - UEFI BIOS
- ◆ Ethernet
  - LAN1&2: Intel® I210-AT PCIe controller
  - LAN3&4: Inphi CS4227 PHY (optional)
- ◆ Display Output
  - 1 x VGA (up to 1920x1200@60 Hz)
- ◆ External I/O Interface
  - 1 x KB/MS
  - 2 x USB 2.0
  - 1 x RS-232
  - 4 x USB 3.1 Gen 1 (5Gb/s)
- ◆ Internal I/O Interface
  - 1 x KB/MS (1x6 pin)
  - 1 x RS-232/RS-422/485 (2x5 pin, P=2.54)
  - 1 x USB 2.0 (180° Type-A)
  - 4 x RS-232 (2x5 pin, P=2.54)
  - 4 x USB 2.0 (2x4 pin, P=2.54)
  - 6 x SATA 6Gb/s (RAID 0/1/5/10 supported)
- ◆ Front Panel
  - 1 x Front panel (2x7 pin, power LED, HDD LED, speaker, power button, reset button)
- ◆ LAN LED
  - 2 x LAN LED (1x2 pin)
- ◆ TPM
  - 1 x TPM (2x10 pin)
- ◆ SMBus
  - 1 x SMBus (1x4 pin)
- ◆ I<sup>2</sup>C
  - 1 x I<sup>2</sup>C (1x4 pin)
- ◆ Expansion
  - 1 x 10GbE LAN card slot
  - 1 x M.2 connector (M key, 2242~2280, SATA & PCIe x2 signal)
  - 1 x PCIe x4 Gen 2
  - 5 x PCIe x4 Gen 3
- ◆ Watchdog Timer
  - Software programmable supports 1~255 sec. system reset
- ◆ Digital I/O
  - 8-bit digital I/O (2x5 pin)
- ◆ Fan Connector
  - 1 x CPU smart fan (1x4 pin)
  - 1 x System smart fan (1x4 pin)
- ◆ Power Supply
  - ATX power supply, ATX/AT mode support
- ◆ Power Consumption
  - 3.3V@0.11A, 5V@2.83A, 12V@3.97A
  - (Intel® Xeon D-1548 2.0GHz CPU with 32GB (four 4 GB) 2133MHz DDR4 memory)
- ◆ Operating Temperature
  - 0°C ~ 60°C
- ◆ Storage Temperature
  - 10°C ~ 70°C
- ◆ Operating Humidity
  - 5% ~ 95%, non-condensing
- ◆ Dimensions
  - 244mm x 305mm
- ◆ Weight
  - GW: 1200g / NW: 700g
- ◆ CE/FCC compliant



## Features

- Intel® Xeon processor D-1500 product family
- Dual-channel 2133 MHz DDR4 up to 128 GB (ECC SO-DIMM, UDIMM, RDIMM)
- 10 GbE LAN supported
- Support PCI Express generation 3.0 at 8GT/s I/O bandwidth
- High speed interface for USB 3.1 Gen 1 (5Gb/s) and SATA 6Gb/s
- IEI One Key Recovery solution allows you to create rapid OS backup and recovery

## Packing List

- 1 x IMBA-BDE single board computer
- 1 x I/O shielding
- 2 x SATA cable
- 1 x QIG

## Ordering Information

Part No.	Description
IMBA-BDE-D1548-R10	ATX motherboard supports 14nm Intel® Xeon® D-1548, DDR4, VGA, dual Intel® GbE, dual 10GbE, six SATA 6Gb/s, four USB 3.1 Gen 1 (5Gb/s), HD Audio and RoHS
IMBA-BDE-D1518-R10	ATX motherboard supports 14nm Intel® Xeon® D-1518, DDR4, VGA, dual Intel® GbE, dual 10GbE, six SATA 6Gb/s, four USB 3.1 Gen 1 (5Gb/s), HD Audio and RoHS
LAN-10G2SF-PHY-CS4227	10 GbE LAN card, dual port support, RoHS
19800-000049-RS	LPT flat cable, 240mm, P=2.54
19800-000075-RS	PS/2 KB/MS cable with bracket, 220mm, P=2.0
19800-003100-100-RS	Dual port USB cable with bracket, 300mm, P=2.54
19800-020100-100-RS	RS-232 cable with bracket, Dual 10-pin to dual DB-9, 230mm, P=2.54
32102-000100-200-RS	SATA power cable, MOLEX 5264-4P to SATA15P
32205-003800-300-RS	RS-422/485 cable, 200mm, P=2.0
TPM-IN01-R20	20-pin Infineon TPM module, software management tool, firmware v3.17



# IMBA-H810

ATX motherboard supports 22nm LGA 1150 4th generation Intel® Core™ i7/i5/i3, Pentium® and Celeron® CPU with Intel® H81, DDR3, VGA/DVI-D/iDP, dual Intel® PCIe GbE, USB 3.1 Gen 1 (5Gb/s), SATA 6Gb/s, HD Audio and RoHS

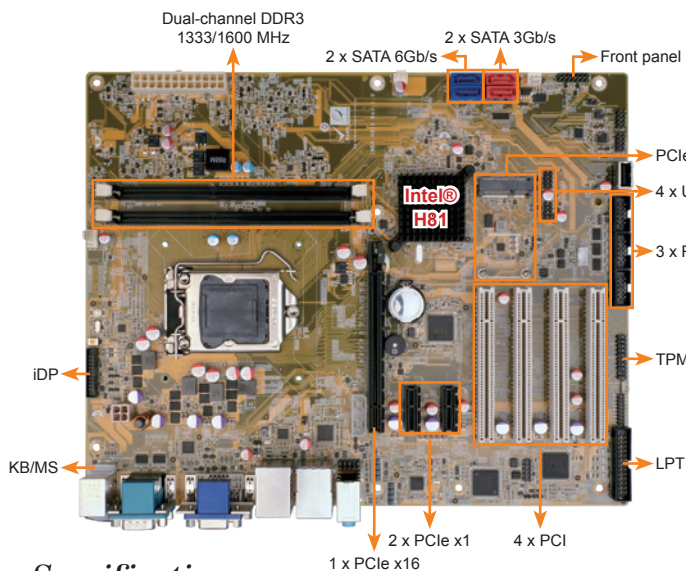

## Specifications

- ◆ CPU  
LGA1150 Intel® Core™ i7/i5/i3, Pentium® and Celeron® processor supported
- ◆ Chipset  
Intel® H81
- ◆ Memory  
Two 240-pin 1600/1333 MHz dual-channel DDR3 SDRAM ECC and non-ECC unbuffered DIMMs support up to 16GB
- ◆ BIOS  
UEFI BIOS
- ◆ Graphics Engine  
Intel® HD Graphics Gen 7.5 supports DX11.1 and OpenCL 1.2, OpenGL 3.2 Full MPEG2, VC1, AVC Decode
- ◆ Display Output  
Dual independent display  
1 x VGA (up to 1920x1200@60 Hz)  
1 x DVI-D (up to 2560x1600@60 Hz)  
1 x iDP interface for HDMI, LVDS, VGA, DVI, DP (up to 3840x2160@60 Hz)
- ◆ Ethernet  
LAN1: Intel® I217-LM with Intel® AMT9.0 support  
LAN2: Intel® I211-AT PCIe Controller
- ◆ External I/O Interface  
1 x KB/MS  
2 x RS-232  
2 x USB 2.0  
2 x USB 3.1 Gen 1 (5Gb/s)
- ◆ Internal I/O Interface  
1 x KB/MS (1x6 pin)  
1 x LPT (2x13 pin)  
1 x mSATA (share with SATA4)  
1 x RS-422/485 (1x4 pin, P=2.0)  
2 x SATA 6Gb/s (SATA1, SATA2) (AHCI supported, no RAID) (Blue)  
1 x USB 2.0 (180° Type-A)  
2 x SATA 3Gb/s (SATA3, SATA4) (Red)  
3 x RS-232 (2x5 pin, P=2.54)  
4 x USB 2.0 (2x4 pin, P=2.54)
- ◆ Audio  
Realtek ALC662 HD codec supports 5.1-channel  
3 x Audio jacks (line-out, line-in, mic-in) on rear IO  
1 x Front audio (2x5 pin)
- ◆ Front Panel  
1 x Front panel (2x7 pin, power LED, HDD LED, speaker, power button, reset button)
- ◆ LAN LED  
2 x LAN LED (1x2 pin)
- ◆ TPM  
1 x TPM (2x10 pin)
- ◆ SMBus  
1 x SMBus (1x4 pin)
- ◆ I<sup>2</sup>C  
1 x I<sup>2</sup>C (1x4 pin)
- ◆ Infrared Interface  
1 x Infrared Interface (1x5 pin)
- ◆ Expansion  
1 x Full-size PCIe Mini card slot (support mSATA) 2 x PCIe x1  
1 x PCIe x16 4 x PCI
- ◆ Watchdog Timer  
Software programmable supports 1~255 sec. system reset
- ◆ Digital I/O: 8-bit digital I/O (2x5 pin)
- ◆ Fan Connector  
1 x CPU smart fan (1x 4 pin)  
1 x System fan (1x 3 pin)
- ◆ Chassis Intrusion Detection: 1 x Chassis intrusion connector (1x2 pin)
- ◆ Power Supply: ATX power supply, ATX/AT mode support
- ◆ Power Consumption  
3.3V@0.83A, 5V@2.2A, 12V@3.88A, 5VSB@0.3A  
(Intel® Core™ i7-4770K 3.90GHz CPU with 8 GB (two 4 GB) 1333 MHz DDR3 memory)
- ◆ Operating Temperature: -20°C ~ 60°C
- ◆ Storage Temperature: -30°C ~ 70°C
- ◆ Operating Humidity: 5% ~ 95%, non-condensing
- ◆ Dimensions: 244 mm x 305 mm
- ◆ Weight: GW: 1200g / NW: 700g
- ◆ CE/FCC compliant

## PCIe Mini Add-on Value

### IEI USB 3.1 Gen 1 (5Gb/s) Expanded Solution

The MPCIE-USB3 board can be installed to add two additional SuperSpeed USB 3.1 Gen 1 (5Gb/s) ports for the motherboard via the PCIe Mini slot.

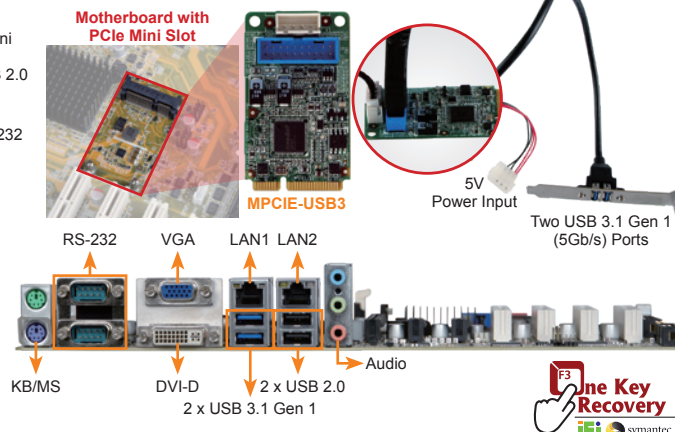

## Features

- 4th generation LGA1150 Intel® Core™ i7/i5/i3, Pentium® or Celeron® processor supported
- Dual-channel DDR3 1333/1600 MHz support up to 16 GB
- Intel® HD Graphics technology integrates high-performance graphics and media processing
- USB 3.1 Gen 1 (5Gb/s), and SATA supported
- TPM V1.2 hardware security function supported by TPM module
- IEI One Key Recovery solution allows you to create rapid OS backup and recovery

## Packing List

1 x IMBA-H810 single board computer	2 x SATA cable
1 x I/O shielding	1 x QIG

## Ordering Information

Part No.	Description
IMBA-H810-R10	ATX motherboard supports 22nm LGA 1150 4th generation Intel® Core™ i7/i5/i3, Pentium® and Celeron® CPU with Intel® H81, DDR3, VGA/DVI-D/iDP, dual Intel® PCIe GbE, SATA 6Gb/s, USB 3.1 Gen 1 (5Gb/s), HD Audio and RoHS
IMBA-H810-ECO-R10	ATX motherboard supports 22nm LGA 1150 4th generation Intel® Core™ i7/i5/i3, Pentium® and Celeron® CPU with Intel® H81, DDR3, VGA/DVI-D/iDP, dual Intel® PCIe GbE, USB 3.1 Gen 1 (5Gb/s), SATA 6Gb/s, HD Audio, ECO packing, RoHS (10 pce/pack)
19800-000049-RS	LPT flat cable, 240mm, P=2.54
19800-000075-RS	PS/2 KB/MS cable with bracket, 220mm, P=2.0
19800-010500-200-RS	USB 3.1 Gen 1 (5Gb/s) cable with bracket, 450mm
19800-020100-100-RS	RS-232 cable with bracket, Dual 10-pin to dual DB-9, 230mm, P=2.54
32102-000100-200-RS	SATA power cable, MOLEX 5264-4P to SATA15P
32205-001203-100-RS	RS-232 cable with bracket, Dual 10-pin to dual DB-9, 230mm, P=2.54
32205-003800-200-RS	RS-422/485 cable, 200mm, P=2.0
CF-115XA-R10	High performance LGA1155/LGA1156 cooler kit, 1U chassis compatible, 73W
CF-115XE-R10	High performance LGA1155/LGA1156 cooler kit, 95W
DP-DP-R10	DisplayPort to DisplayPort converter board (for IEI iDP connector)
DP-DVI-R10	DisplayPort to DVI-D converter board (for IEI iDP connector)
DP-HDMI-R10	DisplayPort to HDMI converter board (for IEI iDP connector)
DP-LVDS-R10	DisplayPort to 24-bit dual-channel LVDS converter board (for IEI iDP connector)
DP-VGA-R10	DisplayPort to VGA converter board (for IEI iDP connector)
TPM-IN01-R20	20-pin Infineon TPM module, software management tool, firmware v3.17

# IMBA-C2260-i2-R11

ATX motherboard supports 22nm LGA1150 Intel® Xeon E3, Core™ i3, Pentium® and Celeron®, DDR3, VGA, dual Intel® PCIe GbE, USB 3.1 Gen 1 (5Gb/s), SATA 6Gb/s, iRIS-2400 and RoHS

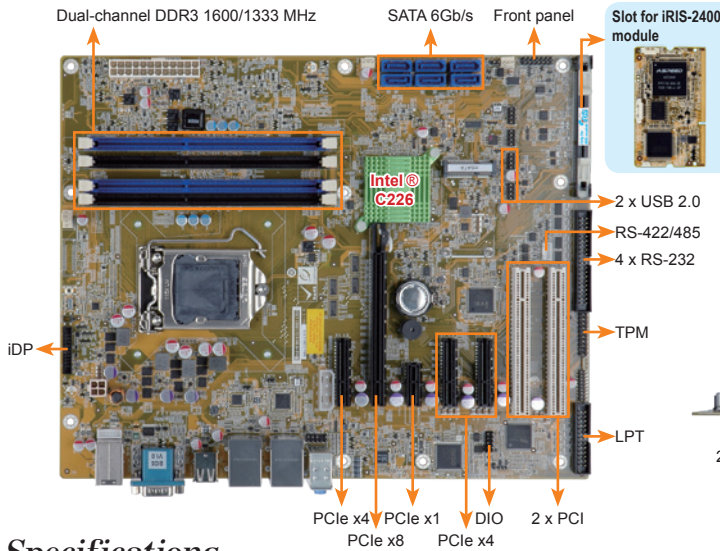

## Fully Jumper-less Support

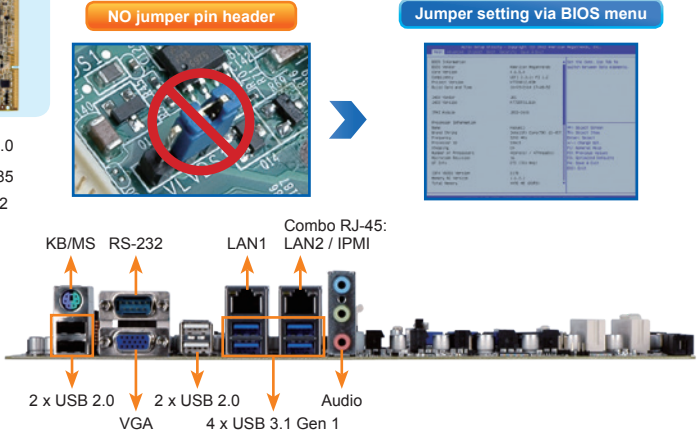

## Specifications

- ◆ CPU  
LGA1150 Intel® Xeon® E3, Core™ i3, Pentium® or Celeron® processor supported
- ◆ Chipset  
Intel® C226
- ◆ Memory  
Four 240-pin 1600/1333 MHz dual-channel DDR3 & DDR3L SDRAM ECC and non-ECC unbuffered DIMMs support up to 32 GB
- ◆ BIOS  
UEFI BIOS
- ◆ Ethernet  
LAN1: Intel® I217LM with Intel® AMT 9.0 support  
LAN2: Intel® I210-AT PCIe controller with NCSI support
- ◆ Graphics Engine  
Intel® HD Graphics Gen 7.5 supports DX11.1 and OpenCL 1.2, OpenGL 3.2  
Full MPEG2, VC1, AVC Decode
- ◆ Display Output  
Triple independent display  
1 x VGA (up to 1920x1200@60 Hz)  
1 x iDP interface for HDMI, LVDS, VGA, DVI, DP (up to 3840x2160@60 Hz)
- ◆ Audio  
Realtek ALC662 HD codec supports 5.1-channel  
3 x Audio jacks (line-out, line-in, mic-in) on rear IO  
1 x Front audio (2x5 pin)
- ◆ External I/O Interface  
1 x KB/MS 4 x USB 2.0  
1 x RS-232 4 x USB 3.1 Gen 1 (5Gb/s)
- ◆ Internal I/O Interface  
1 x KB/MS (1x6 pin) 1 x RS-422/485 (1x4 pin, P=2.0)  
1 x LPT (2x13 pin, P=2.54) 4 x RS-232 (2x20 pin, P=2.54)  
1 x mSATA (colay SATA 6) 4 x USB 2.0 (2x4 pin, P=2.54)  
6 x SATA 6Gb/s (RAID 0/1/5/10 supported)
- ◆ Front Panel  
1 x Front panel (2x7 pin, power LED, HDD LED, speaker, power button, reset button)
- ◆ LAN LED  
2 x LAN LED (1x2 pin)
- ◆ TPM  
1 x TPM (2x10 pin)
- ◆ SMBus  
1 x SMBus (1x4 pin)
- ◆ I<sup>2</sup>C  
1 x I<sup>2</sup>C (1x4 pin)
- ◆ iRIS Remote Management Module: 1 x iRIS-2400 slot
- ◆ Expansion  
1 x PCIe x16 slot  
3 x PCIe x4 slot (support PCIe x1)  
Default setting: 1 x PCIe x8 Gen 3 + 2 x PCIe x4 Gen 3 signal  
Optional setting: 1 x PCIe x16 Gen 3 by BIOS setting  
1 x PCIe x1 slot  
2 x PCI slot
- ◆ Watchdog Timer: Software programmable, support 1~255 sec. system reset
- ◆ Digital I/O: 8-bit digital I/O (2x5 pin)
- ◆ Fan Connector  
1 x CPU fan (1x4 pin) 2 x System fan (1x3 pin)
- ◆ Power Supply: ATX power supply
- ◆ Power Consumption  
3.3V@0.57A, 5V@4.50A, 12V@0.14A, Vcore\_12V@5.20A, 5VSB@0.19A  
(Intel® E3-1240 v3 3.4GHz CPU with 16 GB (4x4 GB) 1333 MHz DDR3 memory)
- ◆ Operating Temperature: -20°C ~ 60°C
- ◆ Storage Temperature: -30°C ~ 70°C
- ◆ Operating Humidity: 5% ~ 95%, non-condensing
- ◆ Dimensions: 244mm x 305mm
- ◆ Weight: GW: 1200g / NW: 700g
- ◆ CE/FCC compliant



## Features

- LGA1150 Intel® Xeon® E3/Core™ i3/Pentium®/Celeron® processor supported
- Dual-channel DDR3 1600/1333 MHz support up to 32 GB
- Intel® PCIe GbE with Intel® AMT 9.0 support
- Support PCI Express generation 3.0 at 8GT/s I/O bandwidth
- USB 3.1 Gen 1 (5Gb/s), SATA 6Gb/s and mSATA supported
- High-speed interface for one PCIe x8 or two PCIe x4 add-on cards
- IEI jumper-less function
- IEI One Key Recovery solution allows you to create rapid OS backup and recovery
- Support IPMI 2.0 via iRIS-2400 module

## Packing List

1 x IMBA-C2260-i2 single board computer	2 x SATA cable
1 x I/O shielding	1 x QIG

## Ordering Information

Part No.	Description
IMBA-C2260-i2-R11	ATX motherboard supports 22nm LGA1150 Intel® Xeon E3, Core™ i3, Pentium® and Celeron® per Intel® C226, DDR3, VGA, Dual Intel® PCIe GbE, HD Audio, four USB 3.1 Gen 1 (5Gb/s), six SATA 6Gb/s, iRIS-2400 and RoHS
iRIS-2400-R10	IPMI 2.0 adapter card with AST2400 BMC chip for DDR3 SO-DIMM socket interface
19800-000049-RS	LPT flat cable, 240mm, P=2.54
19800-000075-RS	PS/2 KB/MS cable with bracket, 220mm, P=2.0
19800-003100-300-RS	Dual port USB cable with bracket, 300mm, P=2.54
19800-010500-200-RS	USB 3.1 Gen 1 (5Gb/s) cable 457mm with bracket
32102-000100-200-RS	SATA power cable, MOLEX 5264-4P to SATA15P
32205-001203-200-RS	RS-232 cable, 40-pin to four DB-9, 400mm, P=2.54
32205-003800-300-RS	RS-422/485 cable, 200mm, P=2.0
CF-115XA-R10	High performance LGA1155/LGA1156 cooler kit, 1U chassis compatible, 73W
CF-115XE-R10	High performance LGA1155/LGA1156 cooler kit, 95W
DP-DP-R10	DisplayPort to DisplayPort converter board (for IEI iDP connector)
DP-DVI-R10	DisplayPort to DVI-D converter board (for IEI iDP connector)
DP-HDMI-R10	DisplayPort to HDMI converter board (for IEI iDP connector)
DP-LVDS-R10	DisplayPort to 24-bit dual-channel LVDS converter board (for IEI iDP connector)
DP-VGA-R10	DisplayPort to VGA converter board (for IEI iDP connector)
TPM-IN01-R20	20-pin Infineon TPM module, software management tool, firmware v3.17



# IMBA-Q870-i2

ATX motherboard supports 22nm LGA1150 Intel® Core™ i7/i5/i3, Pentium® and Celeron® CPU per Intel® Q87, DDR3, triple independent display VGA, DVI-D, HDMI, iDP, USB 3.1 Gen 1 (5Gb/s), SATA 6Gb/s, iRIS-2400

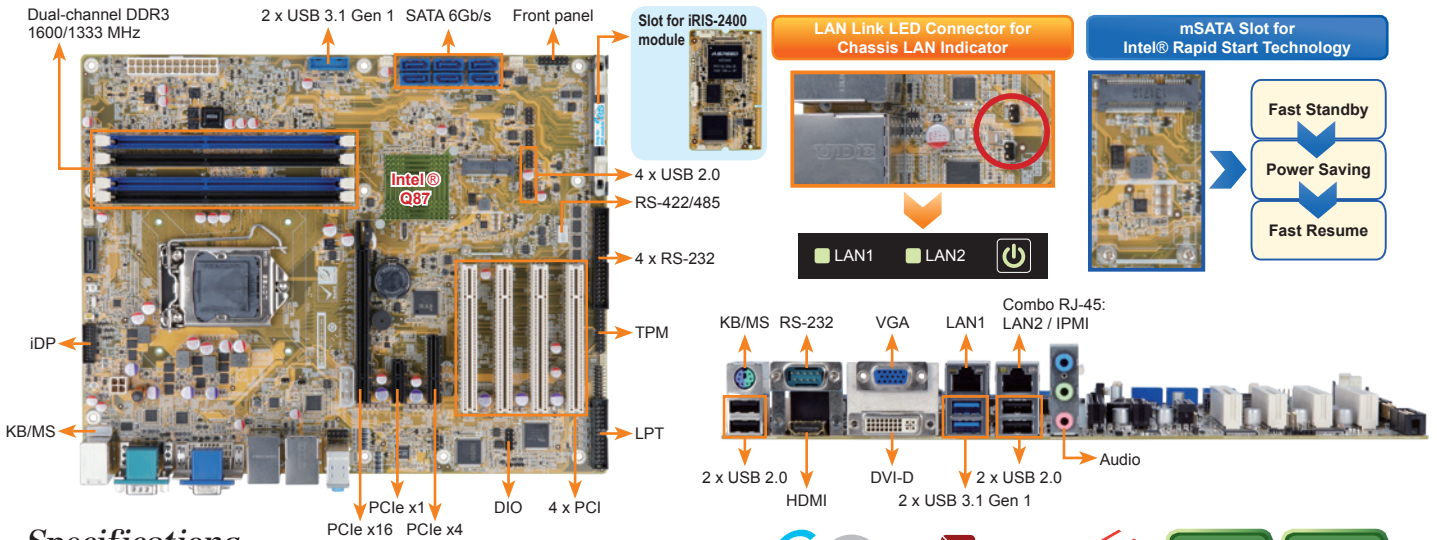

## Specifications

- ◆ CPU  
LGA1150 4th generation Intel® Core™ i7/i5/i3, Pentium® or Celeron® processor supported
- ◆ Chipset  
Intel® Q87
- ◆ Memory  
Four 240-pin 1600/1333 MHz dual-channel DDR3 & DDR3L SDRAM unbuffered DIMMs support up to 32 GB
- ◆ BIOS  
UEFI BIOS
- ◆ Ethernet  
LAN1: Intel® I217LM with Intel® AMT 9.0 support  
LAN2: Intel® I210-AT PCIe controller with NCSI support
- ◆ Graphics Engine  
Intel® HD Graphics Gen 7.5 supports DX11.1 and OpenCL 1.2, OpenGL 3.2 Full MPEG2, VC1, AVC Decode
- ◆ Display Output  
Triple independent display  
1 x VGA (up to 1920x1200@60 Hz)  
1 x DVI-D (up to 2560x1600@60 Hz)  
1 x HDMI (up to 2560x1600@60 Hz)  
1 x iDP interface for HDMI, LVDS, VGA, DVI, DP (up to 3840x2160@60 Hz)
- ◆ Audio  
Realtek ALC662 HD codec supports 5.1-channel  
3 x Audio jacks (line-out, line-in, mic-in) on rear I/O  
1 x Front audio (2x5 pin)
- ◆ External I/O Interface  
1 x KB/MS 2 x USB 3.1 Gen 1 (5Gb/s)  
1 x RS-232 4 x USB 2.0
- ◆ Internal I/O Interface  
1 x KB/MS (1x6 pin) 2 x USB 3.1 Gen 1 (5Gb/s) (2x10 pin, P=2.0)  
1 x LPT (2x13 pin, P=2.54) 4 x RS-232 (2x20 pin, P=2.54)  
1 x mSATA (colay SATA 6) 4 x USB 2.0 (2x4 pin, P=2.54)  
1 x RS-422/485 (1x4 pin, P=2.54) 6 x SATA 6Gb/s (RAID 0/1/5/10 supported)
- ◆ Front Panel  
1 x Front panel (2x7 pin, power LED, HDD LED, speaker, power button, reset button)
- ◆ LAN LED  
2 x LAN LED (1x2 pin)
- ◆ TPM  
1 x TPM (2x10 pin)
- ◆ SMBus  
1 x SMBus (1x4 pin)
- ◆ I<sup>2</sup>C  
1 x I<sup>2</sup>C (1x4 pin)
- ◆ iRIS Remote Management Module: 1 x iRIS-2400 slot
- ◆ Expansion  
1 x PCIe x16 slot (Gen 3) 1 x PCIe x4 slot  
1 x PCIe x1 slot 4 x PCI slots
- ◆ Watchdog Timer  
Software programmable, support 1~255 sec. system reset
- ◆ Digital I/O: 8-bit digital I/O (2x5 pin)
- ◆ Fan Connector  
1 x CPU smart fan (1x4 pin)  
2 x System fan (1x3 pin)
- ◆ Power Supply: ATX Power Supply
- ◆ Power Consumption  
3.3V@0.66A, 5V@4.34A, 12V@0.16A, Vcore\_12V@4.01A, 5VSB@0.21A (Intel® Core™ i7-4770K 3.90 GHz CPU with 16 GB (4x4 GB) 1333 MHz DDR3 memory)
- ◆ Operating Temperature: -20°C ~ 60°C
- ◆ Storage Temperature: -30°C ~ 70°C
- ◆ Operating Humidity: 5% ~ 95%, non-condensing
- ◆ Dimensions: 244mm x 305mm
- ◆ Weight: GW: 1200g / NW: 700g
- ◆ CE/FCC compliant

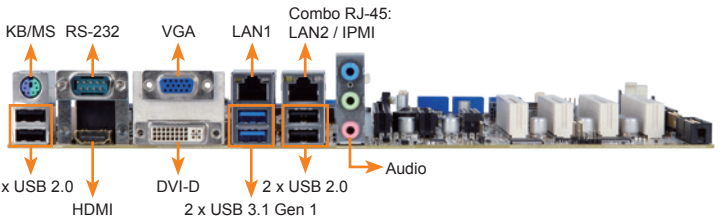

## Features

- LGA1150 4th generation Intel® Core™ i7/i5/i3, Pentium® or Celeron® processor supported
- Dual-channel DDR3 1600/1333 MHz
- Intel® PCIe GbE with Intel® AMT 9.0 support
- Support triple independent display with HDMI, DVI and VGA and iDP
- Support PCI Express generation 3.0 at 8GT/s I/O bandwidth
- USB 3.1 Gen 1 (5Gb/s) and SATA 6Gb/s mSATA supported
- IEI jumper-less function
- IEI One Key Recovery solution allows you to create rapid OS backup and recovery
- Support IPMI 2.0 via iRIS-2400 module

## Packing List

1 x IMBA-Q870-i2 single board computer	2 x SATA cable
1 x I/O shielding	1 x QIG

## Ordering Information

Part No.	Description
IMBA-Q870-i2-R10	ATX motherboard supports 22nm LGA1150 Intel® Core™ i7/i5/i3, Pentium® and Celeron® CPU per Intel® Q87, DDR3, triple independent display VGA/DVI-D/HDMI/iDP, dual Intel® GbE, USB 3.1 Gen 1 (5Gb/s), SATA 6Gb/s, audio, iRIS-2400 and RoHS
IMBA-Q870-ECO-R10	LGA1150 Intel® Core™ i7/i5/i3, Pentium® and Celeron® CPU per Intel® Q87, DDR3, triple independent display VGA, DVI-D, HDMI, iDP, USB 3.1 Gen 1 (5Gb/s), SATA 6Gb/s, ECO packing, RoHS (10 pce/pack)
iRIS-2400-R10	IPMI 2.0 adapter card with AST2400 BMC chip for DDR3 SO-DIMM socket interface
19800-000049-RS	LPT flat cable, 240mm, P=2.54
19800-000075-RS	PS/2 KB/MS cable with bracket, 220mm, P=2.0
19800-003100-300-RS	Dual port USB cable with bracket, 300mm, P=2.54
19800-010500-200-RS	USB 3.1 Gen 1 (5Gb/s) cable 457mm with bracket
32102-000100-200-RS	SATA power cable, MOLEX 5264-4P to SATA15P
32205-001203-200-RS	RS-232 cable, 40-pin to four DB-9, 400mm, P=2.54
32205-003800-300-RS	RS-422/485 cable, 200mm, P=2.0
CF-115XA-R10	High performance LGA1155/LGA1156 cooler kit, 1U chassis compatible, 73W
CF-115XE-R10	High performance LGA1155/LGA1156 cooler kit, 95W
DP-DP-R10	DisplayPort to DisplayPort converter board (for IEI iDP connector)
DP-DVI-R10	DisplayPort to DVI-D converter board (for IEI iDP connector)
DP-HDMI-R10	DisplayPort to HDMI converter board (for IEI iDP connector)
DP-LVDS-R10	DisplayPort to 24-bit dual-channel LVDS converter board (for IEI iDP connector)
DP-VGA-R10	DisplayPort to VGA converter board (for IEI iDP connector)
TPM-IN01-R20	20-pin Infineon TPM module, software management tool, firmware v3.17

# IMBA-H610

ATX motherboard supports LGA1155 Intel® Core™ i7/i5/i3/Pentium®/Celeron® CPU with Intel® H61, DDR3, VGA/DVI-D, dual Realtek PCIe GbE, SATA 3Gb/s, USB 2.0, HD Audio and RoHS

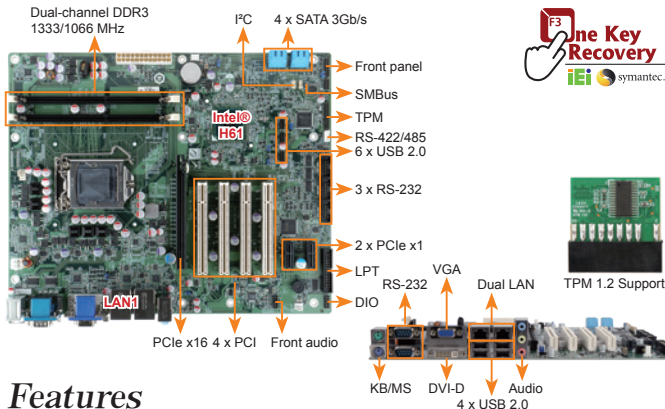

## Features

- LGA1155 Intel® Core™ i7/i5/i3/Pentium®/Celeron® processor supported
- Up to 32GB 1333 MHz dual-channel DDR3 SDRAM
- Intel® HD Graphics technology integrates high-performance graphics and media processing
- TPM V1.2 hardware security provided by the TPM module
- IEI One Key Recovery solution allows you to create rapid OS backup and recovery

## Specifications

- ◆ CPU  
LGA1155 socket supports Intel® Core™ i7/i5/i3/Pentium®/Celeron® processor
- ◆ Chipset: Intel® H61
- ◆ Memory  
Two 240-pin 1333/1066 MHz dual-channel DDR3 SDRAM unbuffered DIMMs support up to 16 GB
- ◆ BIOS: UEFI BIOS
- ◆ Ethernet  
LAN1: Realtek RTL8111E PCIe GbE controller with ASF 2.0 support  
LAN2: Realtek RTL8111E PCIe GbE controller
- ◆ Graphics Engine  
Intel® HD Graphics 2000/3000 (based on CPU type)  
Supports DX10.1 and OpenGL 3.0  
Full MPEG2, VC1, AVC Decode
- ◆ Display Output  
Dual independent display  
1 x VGA (up to 2048x1536@75Hz)  
1 x DVI-D (up to 1920x1200@60Hz)
- ◆ Audio  
Realtek ALC662 HD codec supports 5.1-channel 3 x Audio jacks (line-out, line-in, mic-in) on rear I/O  
1 x Front audio (2x5 pin)
- ◆ TPM: 1 x TPM (2x10 pin)
- ◆ SMBus: 1 x SMBus (1x4 pin)
- ◆ Digital I/O: 8-bit digital I/O (2x5 pin)
- ◆ External I/O Interface  
1 x KB/MS 2 x RS-232 4 x USB 2.0
- ◆ Internal I/O Interface  
1 x LPT(2x13 pin, P=2.54)  
1 x RS-422/485 (1x4 pin, P=2.0)  
4 x RS-232 (2x5 pin, P=2.54)  
4 x SATA 3Gb/s (AHCI supported)  
6 x USB 2.0 (2x4 pin, P=2.54)
- ◆ Front Panel  
1 x Front panel (2x7 pin, power LED, HDD LED, speaker, power button, reset button)
- ◆ Expansion  
1 x PCIe x16 slot 2 x PCIe x1 slot  
4 x PCI slot
- ◆ Watchdog Timer: Software programmable supports 1~255 sec. system reset
- ◆ Fan Connector  
1 x CPU smart fan (1x4 pin)  
2 x System fan (1x3 pin)
- ◆ Power Supply: ATX power supply
- ◆ Power Consumption  
3.3V@1.27A, 5V@3.87A, 12V@0.54A, Vcore@7.67A, 5VSb@0.15A (Intel® Core™ i7-2600K 3.40GHz CPU with two 1333 MHz 2 GB DDR3 memory)
- ◆ Operating Temperature: -10°C ~ 60°C
- ◆ Storage Temperature: -20°C ~ 70°C
- ◆ Operating Humidity: 5% ~ 95%, non-condensing
- ◆ Dimensions: 244 mm x 305 mm
- ◆ Weight: GW: 1200g / NW: 700g
- ◆ CE/FCC compliant

## Packing List

1 x IMBA-H610 single board computer	
4 x SATA cable	1 x Mini jumper pack
1 x I/O shielding	1 x QIG

## Ordering Information

Part No.	Description
IMBA-H610-R10	ATX motherboard supports LGA1155 Intel® Core™ i7/i5/i3/Pentium®/Celeron® CPU with Intel® H61, DDR3, VGA/DVI-D, dual Realtek PCIe GbE, USB 2.0, SATA 3Gb/s, HD Audio and RoHS
19800-000049-RS	LPT flat cable, 240mm, P=2.54
19800-003100-100-RS	Dual port USB cable with bracket, 300mm, P=2.54
19800-020100-100-RS	RS-232 cable with bracket, Dual 10-pin to dual DB-9, 230mm, P=2.54
32102-000100-200-RS	SATA power cable, MOLEX 5264-4P to SATA15P
32205-003800-300-RS	RS-422/485 cable, 200mm, P=2.0
CF-115XA-R10	High-performance LGA1155/LGA1156 cooler kit, 1U chassis compatible, 73W
CF-1156C-R20	LGA1155/LGA1156 cooler kit, 1U chassis compatible, 45W
CF-1156D-R20	LGA1155/LGA1156 cooler kit, 1U chassis compatible, 65W
CF-115XE-R10	High-performance LGA1155/LGA1156 cooler kit, 95W
CPU-DT-C-G440	Intel® Celeron® G440 processor, LGA1155, single core 1.6GHz, 1M cache, 35W, compatible with CF-1156C-R20 CPU cooler
CPU-DT-i3-2120T	Intel® Core™ i3-2120T processor, LGA1155, dual core 2.6GHz, 3M cache, 35W, compatible with CF-1156C-R20 CPU cooler
CPU-DT-i5-2390T	Intel® Core™ i5-2390T processor, LGA1155, dual core 2.7GHz, 3M cache, 35W, AMT, compatible with CF-1156C-R20 CPU cooler
CPU-DT-i5-2500T	Intel® Core™ i5-2500T processor, LGA1155, quad core 2.3GHz, 6M cache, 45W, compatible with CF-1156C-R20 CPU cooler
CPU-DT-P-G630T	Intel® Pentium® G630T processor, LGA1155, dual core 2.3GHz, 3M cache, 35W, compatible with CF-1156C-R20 CPU cooler
TPM-IN01-R20	20-pin Infineon TPM module, software management tool, firmware v3.17

# IMBA-Q670-R30

ATX motherboard supports LGA1155 Intel® Core™ i7/i5/i3/Pentium®/Celeron® CPU with Intel® Q67, DDR3, VGA/DVI-D/HDMI, dual Intel® PCIe GbE, SATA 6Gb/s, USB 3.1 Gen 1 (5Gb/s), HD Audio and RoHS

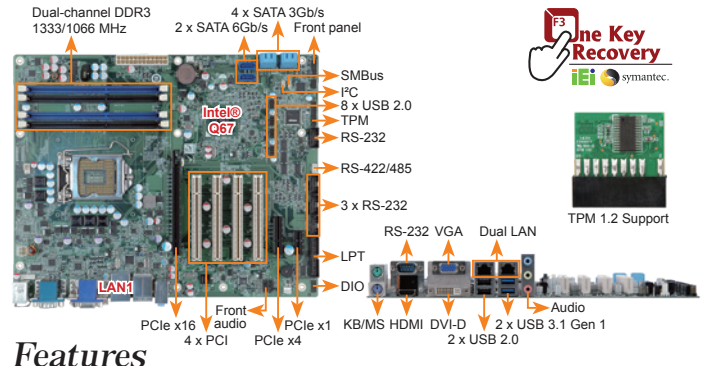

## Features

- LGA1155 Intel® Core™ i7/i5/i3/Pentium®/Celeron® processor supported
- Up to 32 GB 1333 MHz dual-channel DDR3 SDRAM
- Intel® PCIe GbE with Intel® AMT 7.0 support
- USB 3.1 Gen 1 (5Gb/s) and SATA 6Gb/s supported
- IEI One Key Recovery solution allows you to create rapid OS backup and recovery

## Specifications

- ◆ CPU  
LGA1155 socket supports Intel® Core™ i7/i5/i3/Pentium®/Celeron® processor
- ◆ Chipset: Intel® Q67
- ◆ Memory  
Four 240-pin 1333/1066 MHz dual-channel DDR3 SDRAM unbuffered DIMMs support up to 32 GB
- ◆ BIOS: UEFI BIOS
- ◆ Ethernet  
LAN1: Intel® 82583V PCIe controller  
LAN2: Intel® 82579 PHY with Intel® AMT 7.0 supported
- ◆ Graphics Engine  
Support for DX10.1 and OpenGL3.0  
Full MPEG2, VC1, AVC Decode
- ◆ Display Output  
Dual independent display  
1 x VGA (up to 2048x1536@75Hz)  
1 x HDMI (up to 1920x1200@60Hz)  
1 x DVI-D (up to 1920x1200@60Hz)
- ◆ Audio: Realtek ALC662 HD Audio codec  
3 x Audio jacks (line-out, line-in, mic-in) on rear I/O  
1 x Front audio (2x5 pin)
- ◆ TPM: 1 x TPM (2x10 pin)
- ◆ SMBus: 1 x SMBus (1x4 pin)
- ◆ IFC: 1 x IFC (1x4 pin)
- ◆ Digital I/O: 8-bit digital I/O (2x5 pin)
- ◆ External I/O Interface  
1 x KB/MS 2 x USB 2.0  
1 x RS-232 2 x USB 3.1 Gen 1 (5Gb/s)
- ◆ Internal I/O Interface  
1 x KB/MS (1x6 pin)  
1 x LPT (2x13 pin, P=2.54)  
1 x RS-422/485 (1x4 pin, P=2.0)  
2 x SATA 6Gb/s (RAID 0/1/5/10 supported)  
4 x RS-232 (2x5 pin, P=2.54)  
4 x SATA 3Gb/s (RAID 0/1/5/10 supported)  
8 x USB 2.0 (2x4 pin, P=2.54)
- ◆ Expansion  
1 x PCIe x16 slot 1 x PCIe x1 slot  
1 x PCIe x4 slot 4 x PCI slots
- ◆ Watchdog Timer: Software programmable supports 1~255 sec. system reset
- ◆ Fan Connector  
1 x CPU smart fan (1x4 pin)  
2 x System fan (1x3 pin)
- ◆ Power Supply: ATX/AT power supply
- ◆ Power Consumption  
3.3V@1.65A, 5V@6.31A, 12V@0.18A, Vcore@7.88A, 5VSb@0.15 (Intel® Core™ i5-2400 3.10GHz CPU with four 4 GB 1333 MHz DDR3 memory)
- ◆ Operating Temperature: -10°C ~ 60°C
- ◆ Storage Temperature: -20°C ~ 70°C
- ◆ Operating Humidity: 5% ~ 95%, non-condensing
- ◆ Dimensions: 244 mm x 305 mm
- ◆ Weight: GW: 1200g / NW: 700g
- ◆ CE/FCC compliant

## Packing List

1 x IMBA-Q670 single board computer	
1 x I/O shielding	1 x Mini jumper pack
4 x SATA cable	1 x QIG

## Ordering Information

Part No.	Description
IMBA-Q670-R30	ATX motherboard supports LGA1155 Intel® Core™ i7/i5/i3/Pentium®/Celeron® CPU with Intel® Q67, DDR3, VGA/DVI-D/HDMI, dual Intel® PCIe GbE, USB 3.1 Gen 1 (5Gb/s), SATA 6Gb/s, HD Audio and RoHS
19800-000049-RS	LPT flat cable, 240mm, P=2.54
19800-003100-300-RS	Dual port USB cable with bracket, 300mm, P=2.54
19800-020100-100-RS	RS-232 cable with bracket, Dual 10-pin to dual DB-9, 230mm, P=2.54
32102-000100-200-RS	SATA power cable, MOLEX 5264-4P to SATA15P
32205-003800-300-RS	RS-422/485 cable, 200mm
CF-115XA-R10	High-performance LGA1155/LGA1156 cooler kit, 1U chassis compatible, 73W
CF-1156C-R20	LGA1155/LGA1156 cooler kit, 1U chassis compatible, 45W
CF-1156D-R20	LGA1155/LGA1156 cooler kit, 1U chassis compatible, 65W
CF-115XE-R10	High-performance LGA1155/LGA1156 cooler kit, 95W
CPU-DT-C-G440	Intel® Celeron® G440 processor, LGA1155, single core 1.6GHz, 1M cache, 35W, compatible with CF-1156C-R20 CPU cooler
CPU-DT-i3-2120T	Intel® Core™ i3-2120T processor, LGA1155, dual core 2.6GHz, 3M cache, 35W, compatible with CF-1156C-R20 CPU cooler
CPU-DT-i5-2390T	Intel® Core™ i5-2390T processor, LGA1155, dual core 2.7GHz, 3M cache, 35W, AMT, compatible with CF-1156C-R20 CPU cooler
CPU-DT-i5-2500T	Intel® Core™ i5-2500T processor, LGA1155, quad core 2.3GHz, 6M cache, 45W, compatible with CF-1156C-R20 CPU cooler
CPU-DT-P-G630T	Intel® Pentium® G630T processor, LGA1155, dual core 2.3GHz, 3M cache, 35W, compatible with CF-1156C-R20 CPU cooler
TPM-IN01-R20	20-pin Infineon TPM module, software management tool, firmware v3.17



# IMB-H110

microATX Motherboard supports 14nm LGA1151 Intel® Core™ i7/i5/i3, Pentium® or Celeron® processor, DDR4, Dual Independent Displays VGA/ DVI-I/LVDS, Dual GbE LAN, USB 3.1 Gen 1 (5Gb/s), SATA 6Gb/s, HD Audio and RoHS

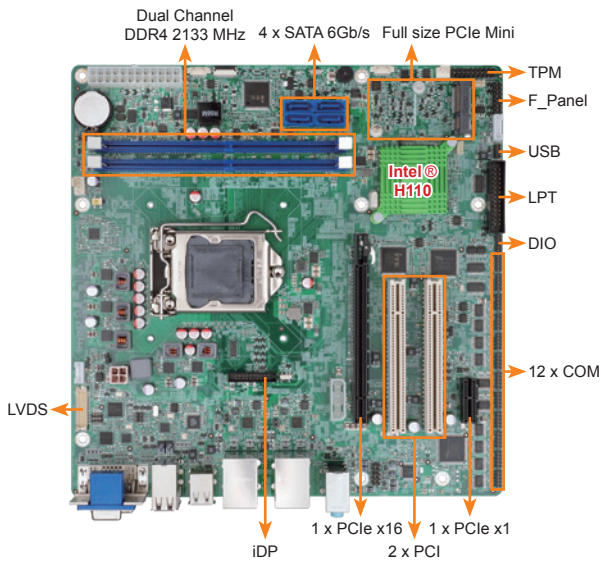

## Specifications

- ◆ CPU  
LGA 1151 socket supports Intel® 6th/7th generation Core™ i7/i5/i3, Pentium® or Celeron® processor
- ◆ Chipset  
Intel® skylake H110
- ◆ Memory  
Two 288-pin 2133MHz Dual-Channel DDR4 SDRAM Unbuffered DIMM supported up to 64GB
- ◆ BIOS  
UEFI BIOS
- ◆ Graphics Engine  
Intel® HD Graphics Gen 9 Engines with Low power 16 execution unit, supports DX2015, OpenGL 5.X and OpenCL2.x, ES 2.0
- ◆ Display Output  
Dual independent display  
1 x VGA (up to 1920x1200@60Hz)  
1 x DVI-I (up to 1920x1200@ 60Hz)  
1 x 18/24-bit dual-channel LVDS (up to 1920x1200@60Hz)  
1 x iDP interface for HDMI, LVDS, VGA, DVI, DP (up to 3840x2160@60Hz)
- ◆ Ethernet  
LAN1: RTL 8111GN controller  
LAN2: RTL 8111GN controller
- ◆ External I/O Interface  
4 x USB 3.1 Gen 1 (5Gb/s)  
6 x USB 2.0
- ◆ Internal I/O Interface  
1 x KB/MS (1x6 pin)                      2 x RS-232/422/485 (2x5 pin, P=2.0)  
1 x LPT (2x13 pin, P=2.54)              2 x USB 2.0 (2x4 pin, P=2.0)  
4 x SATA 6Gb/s                              10 x RS-232 (2x5 pin, P=2.0)
- ◆ SMBus  
1 x SMBus (1x4 pin)
- ◆ TPM  
1 x TPM (2x10 pin)
- ◆ Audio  
Realtek ALC662 HD Audio codec supports 5.1-channel  
3 x Audio jacks (line-out, line-in, mic-in) on rear IO  
1 x Front audio (2x5 pin)
- ◆ Front Panel  
1 x Front Panel (2x7 pin, Power LED, HDD LED, Speaker, Power Button, Reset Button)
- ◆ LAN LED  
2 x LAN LED (1x2 pin)
- ◆ I<sup>2</sup>C  
1 x I<sup>2</sup>C (1x4 pin)
- ◆ Expansion  
1 x PCIe x16 slot (Gen3)                      1 x Full/Half-size PCIe Mini card slot  
1 x PCIe x1 slot (Gen2)                      2 x PCI slot
- ◆ Watchdog Timer  
Software programmable, supports 1~255 sec. system reset
- ◆ Digital I/O: 8-bit Digital I/O (2x5 pin)
- ◆ Fan Connector  
1 x CPU smart fan (1x4 pin)  
1 x System fan (1x3 pin)
- ◆ Power Supply: ATX/AT Power Supply
- ◆ Power Consumption  
3.3V@ 0.93A, 5V@2.99A, 12V@6.88A, 5VSB@0.02A (Intel® Core™ i7-6700K 4.0GHz CPU with 16GB (two 8GB) 2133 MHz DDR4 memory)
- ◆ Operating Temperature: -20°C ~ 60°C
- ◆ Storage Temperature: -30°C ~ 70°C
- ◆ Operating Humidity: 5% ~ 9%, non-condensing
- ◆ Weight: GW: 1200g / NW: 700g
- ◆ CE/FCC compliant

## Multiple Expansion Support

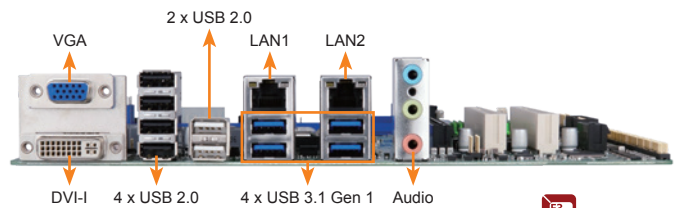

## Features

- LGA 1151 Intel® 6th/7th generation Core™ i7/i5/i3, Pentium® or Celeron® processor supported
- Dual-channel DDR4 2133MHz support up to 64GB
- Support Dual displays via VGA/DVI-I/LVDS
- USB 3.1 Gen 1 (5Gb/s) and SATA 6Gb/s supported
- 12 COM & 12 USB
- IEI One Key Recovery solution allows you to create rapid OS backup and recovery

## Packing List

1 x IMB-H110 motherboard	2 x SATA cable
1 x I/O shielding	1 x QIG

## Ordering Information

Part No.	Description
IMB-H110-R10	microATX motherboard supports 14nm LGA1151 Intel® Core™ i7/i5/i3, Pentium® or Celeron® processor supported, DDR4, Dual independent displays VGA/DVI-I/LVDS, Dual GbE LAN, USB 3.1 Gen 1 (5Gb/s), SATA 6Gb/s, HD Audio and RoHS
IMB-H110-ECO-R10	microATX Motherboard supports 14nm LGA1151 6th Generation Intel® Core™ i7/i5/i3, Pentium® or Celeron® processor per Intel® H110, DDR4, VGA/DVI-I/LVDS, Dual GbE LAN, USB 3.1 Gen 1 (5Gb/s), SATA 6Gb/s, HD Audio, ECO Packing and RoHS
19800-000049-RS	LPT flat cable, 240mm, P=2.54
19800-000075-RS	PS/2 KB/MS cable with bracket, 220mm, P=2.0
19800-000200-100-RS	RS-232 cable with bracket, Dual 10-pin to dual DB-9, 300mm, P=2.0
32102-000100-200-RS	SATA power cable, MOLEX 5264-4P to SATA15P
CF-115XA-R10	High performance LGA1155/LGA1156 cooler kit, 1U chassis compatible, 73W
CF-115XE-R10	High performance LGA1155/LGA1156 cooler kit, 95W
DP-DP-R10	DisplayPort to DisplayPort converter board (for IEI iDP connector)
DP-DVI-R10	DisplayPort to DVI-D converter board (for IEI iDP connector)
DP-HDMI-R10	DisplayPort to HDMI converter board (for IEI iDP connector)
DP-LVDS-R10	DisplayPort to 24-bit dual-channel LVDS converter board (for IEI iDP connector)
DP-VGA-R10	DisplayPort to VGA converter board (for IEI iDP connector)
TPM-IN02-R20	20-pin Infineon TPM 2.0 module, software management tool, firmware v5.5

# IMB-Q870-i2

microATX motherboard supports 22nm LGA1150 Intel® Core™ i7/i5/i3, Pentium® and Celeron® CPU per Intel® Q87, DDR3, HDMI, DVI-D, VGA, iDP, USB 3.1 Gen 1 (5Gb/s), SATA 6Gb/s, six serial ports, iRIS-2400

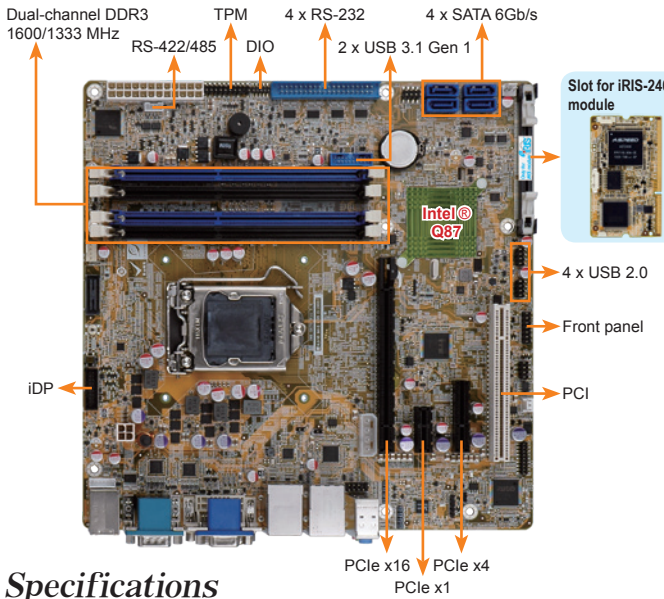

## New and More Powerful Graphics

2nd Generation Intel® Core™ Processor (Sandy Bridge)	3rd Generation Intel® Core™ Processor (Ivy Bridge)	4th Generation Intel® Core™ Processor (Haswell)	
Intel® HD Graphics 3000 series	Intel® HD Graphics 4000 series	GT3-Intel® HD Graphics 5000 series	Core i7
Intel® HD Graphics 2000 series	Intel® HD Graphics 2500 series	GT2-Intel® HD Graphics 4000 series	Core i5/ Core i3
Intel® HD Graphics series	Intel® HD Graphics series	GT1-Intel® HD Graphics series	Celeron/ Pentium

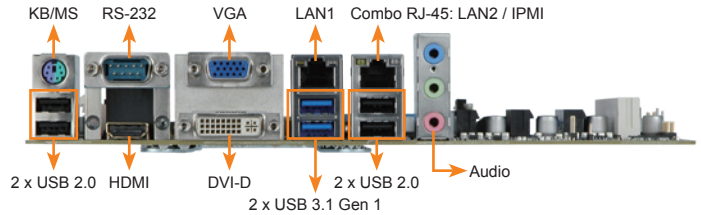

## Specifications

- ◆ CPU: LGA1150 Intel® Core™ i7/i5/i3, Pentium® or Celeron® processor supported
- ◆ Chipset: Intel® Q87
- ◆ Memory: Four 240-pin 1600/1333 MHz dual-channel DDR3 & DDR3L SDRAM unbuffered DIMMs support up to 32 GB
- ◆ BIOS: UEFI BIOS
- ◆ Ethernet: LAN1: Intel® I217LM with Intel® AMT 9.0 support; LAN2: Intel® I210-AT PCIe controller with NCSI support
- ◆ Graphics Engine: Intel® HD Graphics Gen 7.5 supports DX11.1 and OpenCL 1.2, OpenGL 3.2; Full MPEG2, VC1, AVC Decode
- ◆ Display Output: Triple independent display; 1 x VGA (up to 1920x1200@60Hz); 1 x DVI-D (up to 2560x1600@60Hz); 1 x HDMI (up to 2560x1600@60Hz); 1 x iDP interface for HDMI, LVDS, VGA, DVI, DP (up to 3840x2160@60Hz)
- ◆ Audio: Realtek ALC662 HD Audio codec supports 5.1-channel; 3 x Audio jacks (line-out, line-in, mic-in) on rear IO; 1 x Front audio (2x5 pin)
- ◆ External I/O Interface: 1 x KB/MS, 2 x USB 3.1 Gen 1 (5Gb/s); 1 x RS-232, 4 x USB 2.0
- ◆ Internal I/O Interface: 1 x KB/MS (1x6 pin), 4 x SATA 6Gb/s (RAID 0/1/5/10 supported); 1 x RS-422/485 (1x4 pin, P=2.0), 4 x RS-232 (2x5 pin, P=2.54); 2 x USB 3.1 Gen 1 (5Gb/s) (2x10 pin), 4 x USB 2.0 (2x4 pin, P=2.54)
- ◆ Front Panel: 1 x Front panel (2x7 pin, power LED, HDD LED, speaker, power button, reset button)
- ◆ LAN LED: 2 x LAN LED (1x2 pin)
- ◆ TPM: 1 x TPM (2x10 pin)
- ◆ SMBus: 1 x SMBus (1x4 pin)
- ◆ I<sup>2</sup>C: 1 x I<sup>2</sup>C (1x4 pin)
- ◆ iRIS Remote Management Module: 1 x iRIS-2400 slot
- ◆ Expansion: 1 x PCIe x16 slot (Gen 3), 1 x PCIe x4 slot; 1 x PCIe x1 slot, 1 x PCI slot
- ◆ Watchdog Timer: Software programmable, support 1~255 sec. system reset
- ◆ Digital I/O: 8-bit digital I/O (2x5 pin)
- ◆ Fan Connector: 1 x CPU smart fan (1x4 pin), 2 x System smart fan (1x3 pin)
- ◆ Power Supply: ATX power supply
- ◆ Power Consumption: 3.3V@0.53A, 5V@4.96A, 12V@0.12A, Vcore\_12V@3.95A, 5VSB@0.18A (Intel® Core™ i7-4770K 3.90 GHz CPU with 16 GB (4x4 GB) 1333 MHz DDR3 memory)
- ◆ Operating Temperature: -20°C ~ 60°C
- ◆ Storage Temperature: -30°C ~ 70°C
- ◆ Operating Humidity: 5% ~ 95%, non-condensing
- ◆ Dimensions: 244mm x 244mm
- ◆ Weight: GW: 1200g / NW: 700g
- ◆ CE/FCC compliant



## Features

- LGA1150 4th generation Intel® Core™ i7/i5/i3, Pentium® or Celeron® processor supported
- Dual-channel DDR3 1600/1333 MHz supported
- Intel® PCIe GbE with Intel® AMT 9.0 support
- Support triple display via HDMI, DVI, VGA and iDP
- Support PCI Express generation 3.0 at 8GT/s I/O bandwidth
- USB 3.1 Gen 1 (5Gb/s) and SATA 6Gb/s supported
- IEI jumper-less function
- IEI One Key Recovery solution allows you to create rapid OS backup and recovery
- Support IPMI 2.0 via iRIS-2400 module

## Packing List

1 x IMB-Q870-i2 single board computer	2 x SATA cable
1 x I/O shielding	1 x QIG

## Ordering Information

Part No.	Description
IMB-Q870-i2-R10	microATX motherboard supports 22nm LGA1150 Intel® Core™ i7/i5/i3/Pentium® and Celeron® CPU per Intel® Q87, DDR3, dual Intel® PCIe GbE, HDMI, DVI-D, VGA, DP, audio, SATA 6Gb/s, USB 3.1 Gen 1 (5Gb/s), six serial ports, iRIS-2400 and RoHS
iRIS-2400-R10	IPMI 2.0 adapter card with AST2400 BMC chip for DDR3 SO-DIMM socket interface
19800-000049-RS	LPT flat cable, 240mm, P=2.54
19800-000075-RS	PS/2 KB/MS cable with bracket, 220mm, P=2.0
19800-003100-300-RS	Dual port USB cable with bracket, 300mm, P=2.54
19800-010500-200-RS	USB 3.1 Gen 1 (5Gb/s) cable with bracket, 450mm
32102-000100-200-RS	SATA power cable, MOLEX 5264-4P to SATA15P
32205-001203-200-RS	RS-232 cable, 40-pin to four DB-9, 400mm, P=2.54
32205-003800-300-RS	RS-422/485 cable, 200mm, P=2.0
CF-115XA-R10	High performance LGA1155/LGA1156 cooler kit, 1U chassis compatible, 73W
CF-115XE-R10	High performance LGA1155/LGA1156 cooler kit, 95W
DP-DP-R10	DisplayPort to DisplayPort converter board (for IEI iDP connector)
DP-DVI-R10	DisplayPort to DVI-D converter board (for IEI iDP connector)
DP-HDMI-R10	DisplayPort to HDMI converter board (for IEI iDP connector)
DP-LVDS-R10	DisplayPort to 24-bit dual-channel LVDS converter board (for IEI iDP connector)
DP-VGA-R10	DisplayPort to VGA converter board (for IEI iDP connector)
TPM-IN01-R20	20-pin Infineon TPM module, software management tool, firmware v3.17

# IMB-H810-i2-R11

microATX motherboard supports 22nm LGA1150 Intel® Core™ i7/i5/i3, Pentium®, Celeron® CPU per Intel® H81, DDR3, VGA, dual GbE, LPT, COM, SATA 6Gb/s, iRIS-2400

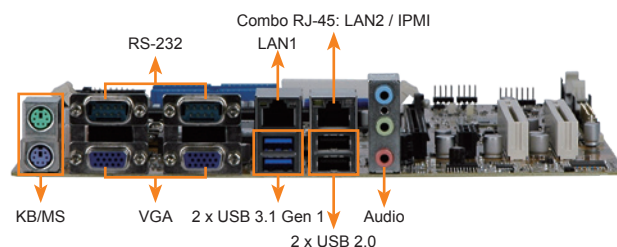
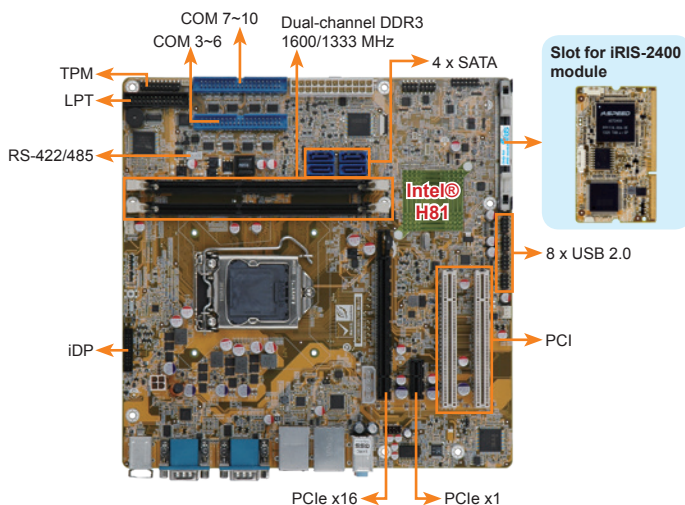

## Specifications

- ◆ CPU  
LGA1150 Intel® Core™ i7/i5/i3, Pentium® or Celeron® processor supported
- ◆ Chipset  
Intel® H81
- ◆ Memory  
Two 240-pin 1600/1333 MHz dual-channel DDR3 & DDR3L SDRAM unbuffered DIMMs support up to 16 GB
- ◆ BIOS  
UEFI BIOS
- ◆ Ethernet  
LAN1: Intel® I217LM with Intel® AMT9.0 support  
LAN2: Intel® I210-AT PCIe controller with NCSI support
- ◆ Graphics Engine  
Intel® HD Graphics Gen 7.5 supports DX11.1 and OpenCL 1.2, OpenGL 3.2 Full MPEG2, VC1, AVC Decode
- ◆ Display Output  
Dual independent display  
2 x VGA (up to 1920x1200@60Hz)  
1 x iDP interface for HDMI, LVDS, VGA, DVI, DP (up to 3840x2160@60Hz)
- ◆ Audio  
Realtek ALC662 HD Audio codec supports 5.1-channel  
3 x Audio jacks (line-out, line-in, mic-in) on rear IO  
1 x Front audio (2x5 pin)
- ◆ iRIS Remote Management Module  
1 x iRIS-2400 slot
- ◆ TPM  
1 x TPM (2x10 pin)
- ◆ SMBus  
1 x SMBus (1x4 pin)
- ◆ iPC  
1 x iPC (1x4 pin)
- ◆ LAN LED: 2 x LAN LED (1x2 pin)
- ◆ External I/O Interface  
1 x KB/MS 2 x USB 2.0  
2 x RS-232 2 x USB 3.1 Gen 1 (5Gb/s)
- ◆ Internal I/O Interface  
1 x LPT (2x13 pin, P=2.54) 2 x SATA 6Gb/s  
1 x RS-422/485 (1x4 pin, P=2.0) 8 x RS-232 (2x20 pin, P=2.54)  
2 x SATA 3Gb/s 8 x USB 2.0 (2x4 pin, P=2.54)
- ◆ Front Panel  
1 x Front panel (2x7 pin, power LED, HDD LED, speaker, power button, reset button)
- ◆ Expansion  
1 x PCIe x16 slot (Gen 3)  
1 x PCIe x1 slot  
2 x PCI slot
- ◆ Watchdog Timer  
Software programmable, support S 1~255 sec system reset
- ◆ Fan Connector  
1 x CPU smart fan (1x4 pin)  
1 x System smart fan (1x3 pin)
- ◆ Power Supply  
ATX power supply
- ◆ Power Consumption  
3.3V@0.64A, 5V@4.20A, 12V@0.14A, Vcore\_12V@3.88A, 5VSB@0.20A  
(Intel® Core™ i7-4770K 3.90 GHz CPU with 8 GB (two 4 GB) 1333 MHz DDR3 memory)
- ◆ Operating Temperature: -20°C ~ 60°C
- ◆ Storage Temperature: -30°C ~ 70°C
- ◆ Operating Humidity: 5% ~ 95%, non-condensing
- ◆ Dimensions: 244mm x 244mm
- ◆ Weight: GW: 1200g / NW: 680g
- ◆ CE/FCC compliant

## Features

- LGA1150 4th generation Intel® Core™ i7/i5/i3, Pentium® or Celeron® processor supported
- Dual-channel DDR3 1333/1600 MHz support up to 16 GB
- Intel® HD Graphics technology integrates high-performance graphics and media processing
- Supports legacy PCI 32-bit 33/66 MHz
- Ten COM ports, USB 3.1 Gen 1 (5Gb/s) and SATA supported
- TPM V1.2 hardware security function supported by TPM module
- IEI One Key Recovery solution allows you to create rapid OS backup and recovery
- Support IPMI 2.0 via iRIS-2400 module
- IEI jumper-less function

## Packing List

1 x IMB-H810-i2 single board computer	2 x SATA cable
1 x I/O shielding	1 x QIG

## Ordering Information

Part No.	Description
IMB-H810-i2-R11	microATX motherboard supports 22nm LGA1150 Intel® Core™ i7/i5/i3/Pentium® and Celeron® CPU per Intel® H81, DDR3, VGA, Dual Intel® PCIe GbE, USB 2.0, PCI, COM, SATA 6Gb/s, LPT, HD Audio, iRIS-2400 and RoHS
IMB-H810-ECO-R11	LGA1150 Intel® Core™ i7/i5/i3, Pentium® and Celeron® CPU per Intel® H81, DDR3, VGA, Dual PCIe GbE, USB 2.0, COM, LPT, SATA 6Gb/s, HD Audio, ECO packing, RoHS (10 pce/pack)
iRIS-2400-R10	IPMI 2.0 adapter card with AST2400 BMC chip for DDR3 SO-DIMM socket interface
19800-000049-RS	LPT flat cable, 240mm, P=2.54
19800-000075-RS	PS/2 KB/MS cable with bracket, 220mm, P=2.0
19800-003100-100-RS	Dual port USB cable with bracket, 30mm, P=2.54
19800-010500-200-RS	USB 3.1 Gen 1 (5Gb/s) cable with bracket, 450mm
32102-000100-200-RS	SATA power cable, MOLEX 5264-4P to SATA15P
32205-001203-200-RS	RS-232 cable, 40-pin to four DB-9, 400mm, P=2.54
32205-003801-100-RS	RS-232/422/485, RS-422/485 cable, 500mm
CF-115XA-R10	High performance LGA1155/LGA1156 cooler kit, 1U chassis compatible, 73W
CF-115XE-R10	High performance LGA1155/LGA1156 cooler kit, 95W
DP-DP-R10	DisplayPort to DisplayPort converter board (for IEI iDP connector)
DP-DVI-R10	DisplayPort to DVI-D converter board (for IEI iDP connector)
DP-HDMI-R10	DisplayPort to HDMI converter board (for IEI iDP connector)
DP-LVDS-R10	DisplayPort to 24-bit dual-channel LVDS converter board (for IEI iDP connector)
DP-VGA-R10	DisplayPort to VGA converter board (for IEI iDP connector)
TPM-IN01-R20	20-pin Infineon TPM module, software management tool, firmware v3.17



## IMB-Q670-R30

microATX motherboard supports LGA1155 Intel® Core™ i7/i5/i3/Pentium®/Celeron® CPU with Intel® Q67, DDR3, VGA/DVI-D/HDMI, dual Intel® PCIe GbE, USB 3.1 Gen 1 (5Gb/s), COM, SATA 6Gb/s, HD Audio and RoHS

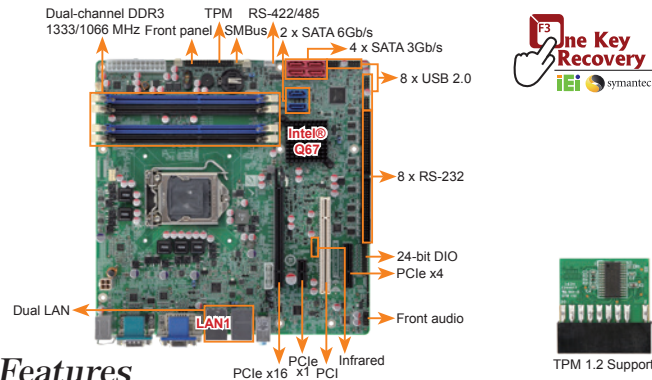

### Features

- LGA1155 Intel® Core™ i7/i5/i3/Pentium®/Celeron® processor supported
- Up to 32 GB 1333 MHz dual-channel DDR3 SDRAM
- Intel® PCIe GbE with Intel® AMT 7.0 support
- USB 3.1 Gen 1 (5Gb/s) and SATA 6Gb/s supported
- IEI One Key Recovery solution allows you to create rapid OS backup and recovery

### Specifications

- ◆ CPU  
LGA1155 socket supports Intel® Core™ i7/i5/i3 quad/dual, Pentium® dual, Celeron® dual/single core processor
- ◆ Chipset: Intel® Q67
- ◆ Memory  
Four 240-pin 1333/1066 MHz dual-channel DDR3 SDRAM unbuffered DIMMs support up to 32GB
- ◆ BIOS: UEFI BIOS
- ◆ Ethernet  
LAN1: Intel® 82583V PCIe controller  
LAN2: Intel® 82579 PHY with Intel® AMT 7.0 support
- ◆ Graphics Engine  
Support for DX10.1 and OpenGL3.0  
Full MPEG2, VC1, AVC Decode
- ◆ Display Output  
Dual independent display  
1 x VGA (up to 2048x1536@75Hz)  
1 x HDMI (up to 1920x1200@60Hz)  
1 x DVI-D (up to 1920x1200@60Hz)
- ◆ Audio: Realtek ALC892 HD Audio codec  
3 x Audio jacks (line-out, line-in, mic-in) on rear IO  
1 x Front audio (2x5 pin)
- ◆ External I/O Interface  
1 x KB/MS 2 x USB 2.0  
1 x RS-232 2 x USB 3.1 Gen 1 (5Gb/s)
- ◆ TPM: 1 x TPM (2x10 pin)
- ◆ SMBus: 1 x SMBus (1x4 pin)
- ◆ Internal I/O Interface  
1 x RS-422/485 (1x4 pin, P=2.0)  
2 x SATA 6Gb/s (RAID 0/1/5/10 supported)  
4 x SATA 3Gb/s (RAID 0/1/5/10 supported)  
8 x USB 2.0 (2x4 pin, P=2.54)  
8 x RS-232 (2x20 pin, P=2.54)
- ◆ Expansion  
1 x PCIe x16 slot  
1 x PCIe x1 slot  
1 x PCIe x4 slot 1 x PCI slot
- ◆ Watchdog Timer  
Software programmable supports 1~255 sec. system reset
- ◆ Digital I/O: 24-bit digital I/O (2x13 pin)
- ◆ Fan Connector  
1 x CPU smart fan (1 x 4 pin)  
1 x NB fan (1x3 pin)  
2 x System fan (1x3 pin)
- ◆ Power Supply: ATX power supply
- ◆ Power Consumption  
3.3V@1.75A, 5V@6.61A, 12V@3.68A, 12V@0.09A, 5VSb@0.12 (Intel® 2.60GHz CPU with four 1333 MHz 4 GB DDR3 DIMMs)
- ◆ Operating Temperature: -10°C ~ 60°C
- ◆ Storage Temperature: -20°C ~ 70°C
- ◆ Operating Humidity: 5% ~ 95%, non-condensing
- ◆ Dimensions: 244mm x 244mm
- ◆ Weight: GW: 1200g / NW: 680g
- ◆ CE/FCC compliant

### Packing List

1 x IMB-Q670 single board computer	4 x SATA cable
1 x I/O shielding	1 x Mini jumper pack
2 x Quad-port RS-232 cable	1 x QIG

### Ordering Information

Part No.	Description
IMB-Q670-R30	microATX motherboard supports LGA1155 Intel® Core™ i7/i5/i3/Pentium®/Celeron® CPU with Intel® Q67, DDR3, VGA/DVI-D/HDMI, dual Intel® PCIe GbE, USB 3.1 Gen 1 (5Gb/s), COM, SATA 6Gb/s, HD Audio and RoHS
19800-003100-100-RS	Dual port USB cable with bracket, 300mm, P=2.54
32102-000100-200-RS	SATA power cable, MOLEX 5264-4P to SATA15P
32205-003800-300-RS	RS-422/485 cable, 200mm, P=2.0
CF-115XA-R10	High-performance LGA1155/LGA1156 cooler kit, 1U chassis compatible, 73W
CF-1156C-R20	LGA1155/LGA1156 cooler kit, 1U chassis compatible, 45W
CF-1156D-R20	LGA1155/LGA1156 cooler kit, 1U chassis compatible, 65W
CF-115XE-R10	High-performance LGA1155/LGA1156 cooler kit, 95W
CPU-DT-C-G440	Intel® Celeron® G440 processor, LGA1155, single core 1.6GHz, 1M cache, 35W, compatible with CF-1156C-R20 CPU cooler
CPU-DT-i3-2120T	Intel® Core™ i3-2120T processor, LGA1155, dual core 2.6GHz, 3M cache, 35W, compatible with CF-1156C-R20 CPU cooler
CPU-DT-i5-2390T	Intel® Core™ i5-2390T processor, LGA1155, dual core 2.7GHz, 3M cache, 35W, AMT, compatible with CF-1156C-R20 CPU cooler
CPU-DT-i5-2500T	Intel® Core™ i5-2500T processor, LGA1155, quad core 2.3GHz, 6M cache, 45W, compatible with CF-1156C-R20 CPU cooler
CPU-DT-P-G630T	Intel® Pentium® G630T processor, LGA1155, dual core 2.3GHz, 3M cache, 35W, compatible with CF-1156C-R20 CPU cooler
TPM-IN01-R20	20-pin Infineon TPM module, software management tool, firmware v3.17

## IMB-H610A

microATX motherboard supports LGA1155 Intel® Core™ i7/i5/i3/Pentium®/Celeron® CPU with Intel® H61, DDR3, VGA/DVI-D, dual Realtek PCIe GbE, USB 2.0, six COMs, SATA 3Gb/s, HD Audio and RoHS

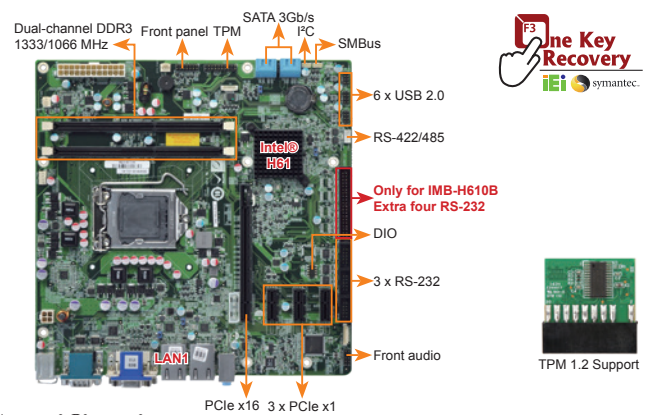

### Specifications

- ◆ CPU  
LGA1155 socket supports Intel® Core™ i7/i5/i3 quad/dual, Pentium® dual and Celeron® dual/single core processors
- ◆ Chipset: Intel® H61
- ◆ Memory  
Two 240-pin 1333/1066 MHz dual-channel DDR3 SDRAM unbuffered DIMMs support up to 16GB
- ◆ BIOS: UEFI BIOS
- ◆ Ethernet  
LAN1: Realtek RTL8111E PCIe GbE controller with ASF 2.0 support  
LAN2: Realtek RTL8111E PCIe GbE controller
- ◆ Graphics Engine  
Intel® HD Graphics 2000/3000 (based on CPU type)  
Supports DX10.1 and OpenGL 3.0  
Full MPEG2, VC1, AVC Decode
- ◆ External I/O Interface  
1 x KB/MS 2 x RS-232 4 x USB 2.0
- ◆ Internal I/O Interface  
1 x RS-422/485 (1x4 pin, P=2.0)  
4 x SATA 3Gb/s 6 x USB 2.0 (2x4 pin, P=2.54)  
3 x RS-232 (2x5 pin, P=2.54, for IMB-H610A-R10)  
8 x RS-232 (2x5 pin, P=2.54, for IMB-H610B-R10)
- ◆ Display Output  
Dual independent display  
1 x VGA (up to 2048x1536@75Hz)  
1 x DVI-D (up to 1920x1200@60Hz)
- ◆ TPM: 1 x TPM (2x10 pin)
- ◆ SMBus: 1 x SMBus (1x4 pin)
- ◆ I²C: 1 x I²C (1x4 pin)
- ◆ Audio  
Realtek ALC662 HD Audio codec  
3 x Audio jacks (line-out, line-in, mic-in) on rear IO  
1 x Front audio (2x5 pin)
- ◆ Front Panel: 1 x Front panel (2x7 pin, power LED, HDD LED, speaker, power button, reset button)
- ◆ Expansion  
1 x PCIe x16 slot  
3 x PCIe x1 slot
- ◆ Watchdog Timer: Software programmable supports 1~255 sec. system reset
- ◆ Digital I/O: 8-bit digital I/O (2x5 pin)
- ◆ Fan Connector  
1 x CPU smart fan (1x4 pin)  
2 x System fan (1x3 pin)
- ◆ Power Supply: ATX power supply
- ◆ Power Consumption  
3.3V@1.75A, 5V@6.61A, Vcore@3.68A, 12V@0.09A, 5sb@0.12A (Intel® 2.60GHz CPU with two 1333 MHz 4 GB DDR3 memory)
- ◆ Operating Temperature: -10°C ~ 60°C
- ◆ Storage Temperature: -20°C ~ 70°C
- ◆ Operating Humidity: 5% ~ 95%, non-condensing
- ◆ Dimensions: 244 mm x 244 mm
- ◆ Weight: GW: 1200g / NW: 680g
- ◆ CE/FCC compliant

### Packing List

1 x IMB-H610 single board computer	1 x Mini jumper pack
1 x I/O shielding	1 x QIG
4 x SATA cable	

### Ordering Information

Part No.	Description
IMB-H610A-R10	microATX motherboard supports LGA1155 Intel® Core™ i7/i5/i3/Pentium®/Celeron® CPU with Intel® H61, DDR3, VGA/DVI-D, dual Realtek PCIe GbE, USB 2.0, 6 COM, SATA 3Gb/s, HD Audio and RoHS
IMB-H610B-R10	microATX motherboard supports LGA1155 Intel® Core™ i7/i5/i3/Pentium®/Celeron® CPU with Intel® H61, DDR3, VGA/DVI-D, dual Realtek PCIe GbE, USB 2.0, 10 COM, SATA 3Gb/s, HD Audio and RoHS
19800-003100-300-RS	Dual port USB cable with bracket, 300mm, P=2.54
19800-003600-100-RS	RS-232 cable with bracket, Dual 10-pin to dual DB-9, 400mm, P=2.54
19800-010900-200-RS	RS-232 cable with bracket, 230mm, P=2.54
32102-000100-200-RS	SATA power cable, MOLEX 5264-4P to SATA15P
32205-001203-200-RS	RS-232 cable, 40-pin to four DB-9, 400mm, P=2.54
32205-003800-300-RS	RS-422/485 cable, 200mm, P=2.0
CF-115XA-R10	High-performance LGA1155/LGA1156 cooler kit, 1U chassis compatible, 73W
CF-1156C-R20	LGA1155/LGA1156 cooler kit, 1U chassis compatible, 45W
CF-1156D-R20	LGA1155/LGA1156 cooler kit, 1U chassis compatible, 65W
CF-115XE-R10	High-performance LGA1155/LGA1156 cooler kit, 95W
CPU-DT-C-G440	Intel® Celeron® G440 processor, LGA1155, single core 1.6GHz, 1M cache, 35W, compatible with CF-1156C-R20 CPU cooler
CPU-DT-i3-2120T	Intel® Core™ i3-2120T processor, LGA1155, dual core 2.6GHz, 3M cache, 35W, compatible with CF-1156C-R20 CPU cooler
CPU-DT-i5-2390T	Intel® Core™ i5-2390T processor, LGA1155, dual core 2.7GHz, 3M cache, 35W, AMT, compatible with CF-1156C-R20 CPU cooler
CPU-DT-i5-2500T	Intel® Core™ i5-2500T processor, LGA1155, quad core 2.3GHz, 6M cache, 45W, compatible with CF-1156C-R20 CPU cooler
CPU-DT-P-G630T	Intel® Pentium® G630T processor, LGA1155, dual core 2.3GHz, 3M cache, 35W, compatible with CF-1156C-R20 CPU cooler
TPM-IN01-R20	20-pin Infineon TPM module, software management tool, firmware v3.17



Dimensions (Unit: mm)

IMBA-C2360-i2

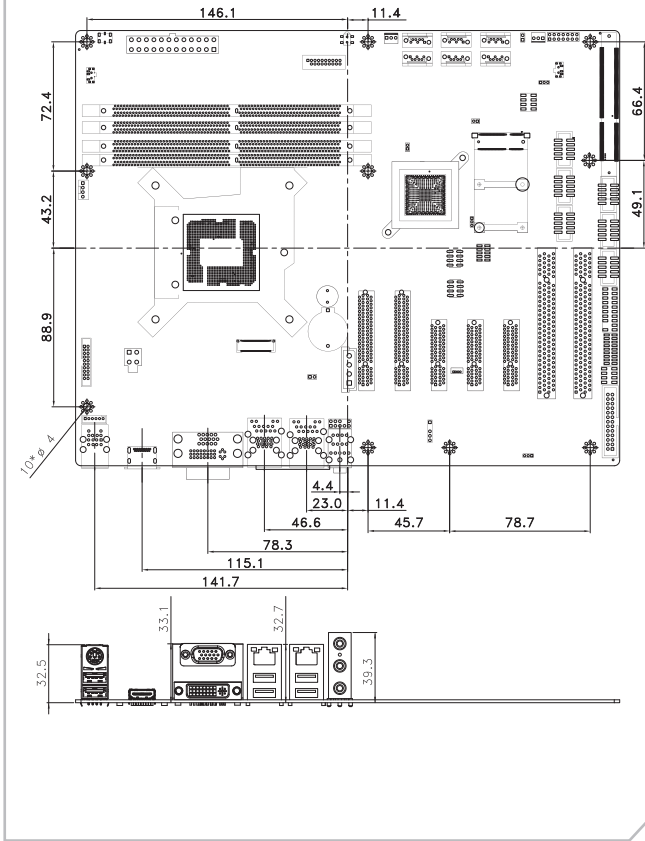

IMBA-H110

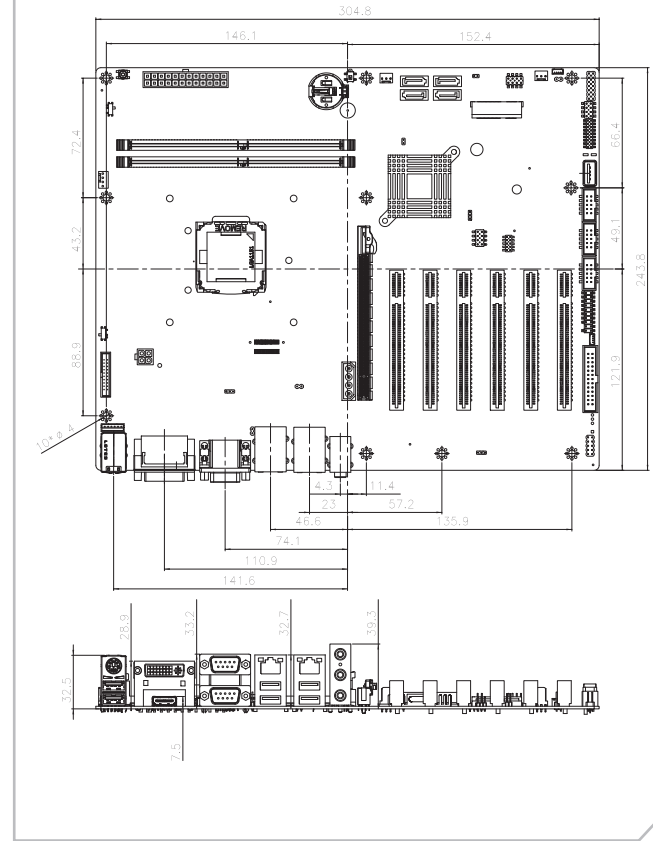

IMBA-Q170-i2

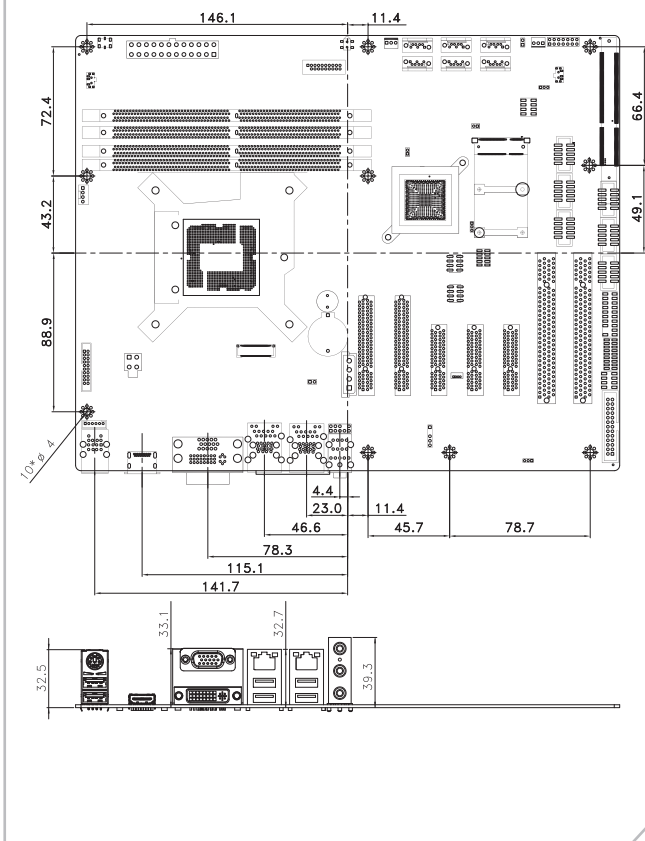

IMBA-BDE

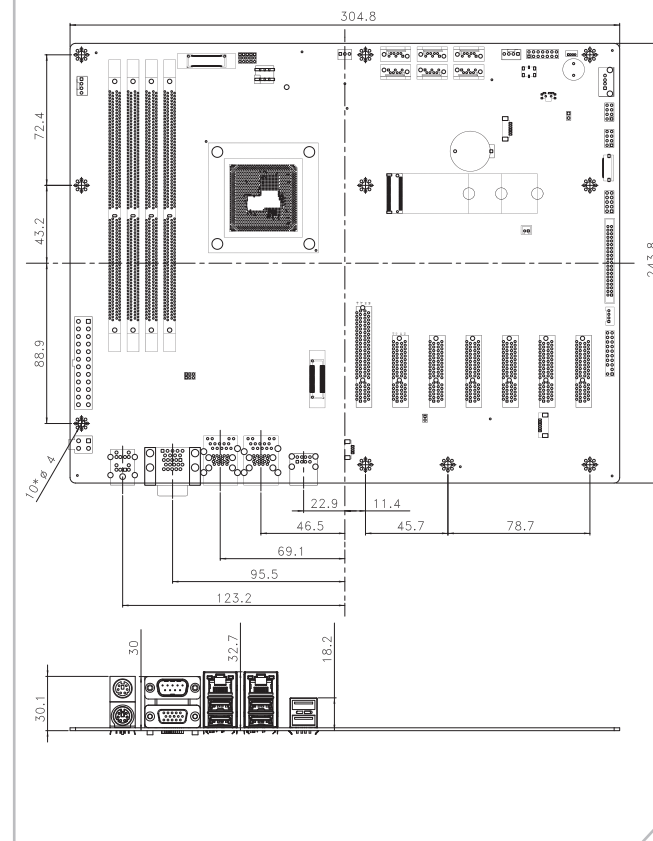

Dimensions (Unit: mm)

IMBA-H810

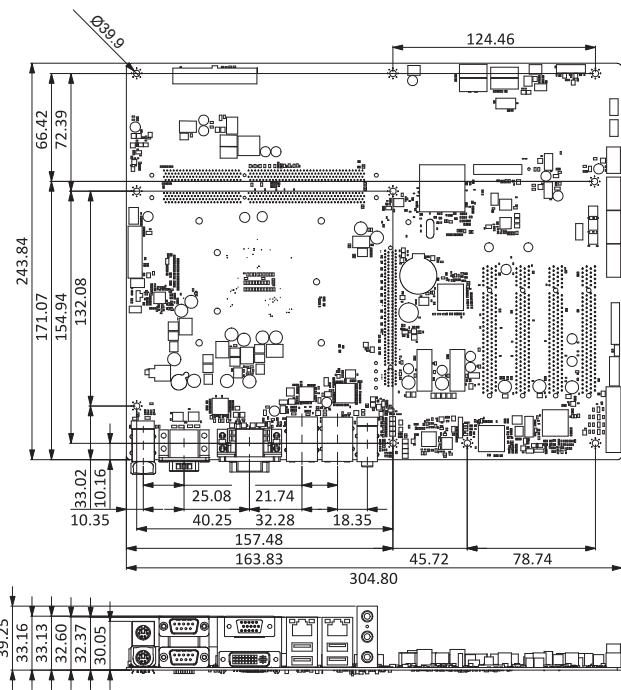

IMBA-Q870-i2

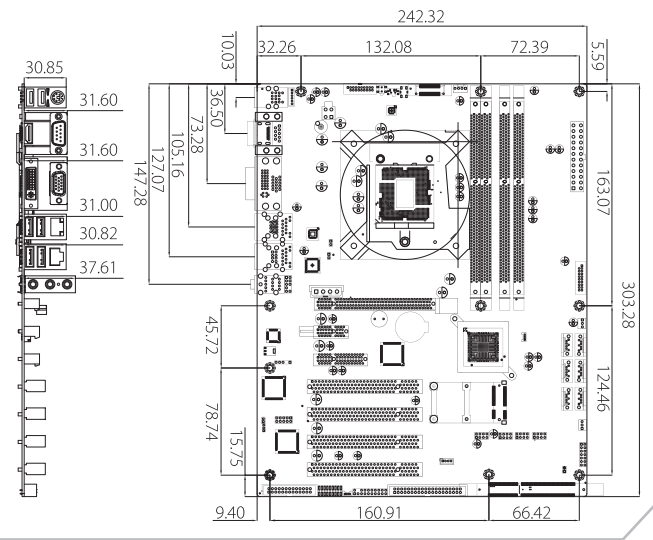

IMBA-H610

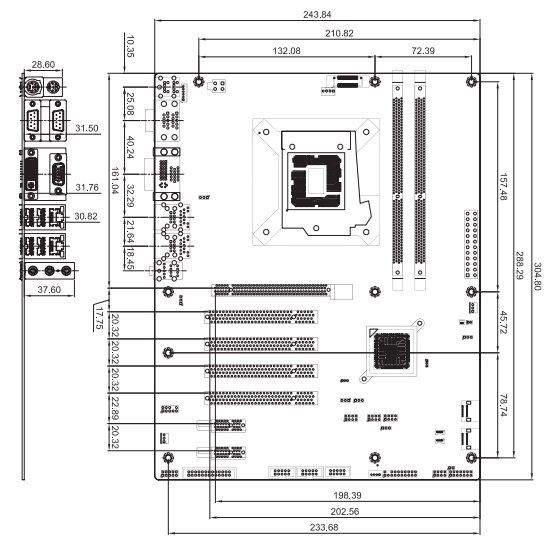

IMBA-C2260-i2-R11

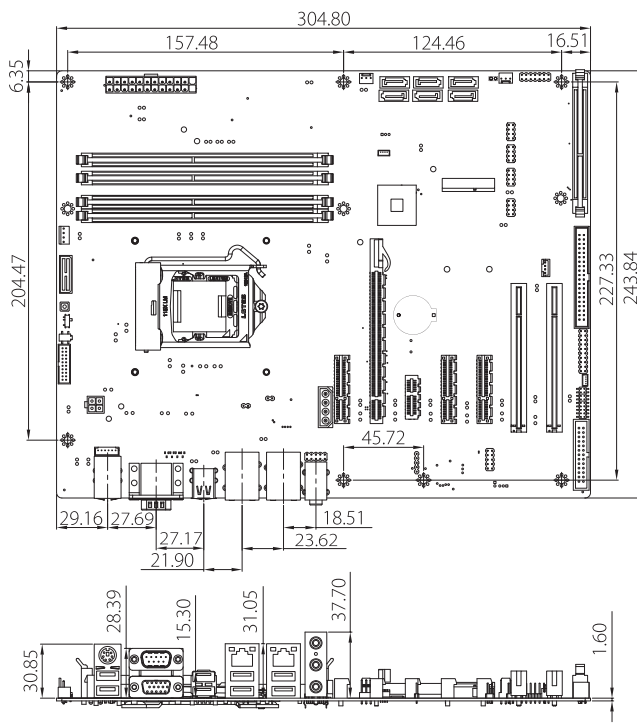

IMBA-Q670-R30

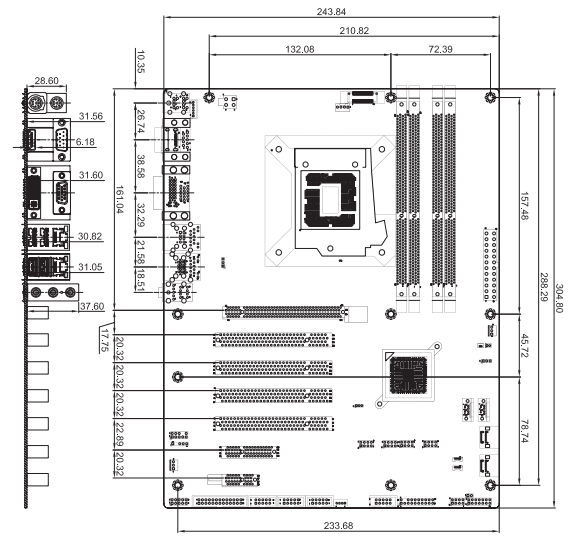

Dimensions (Unit: mm)

IMB-H110

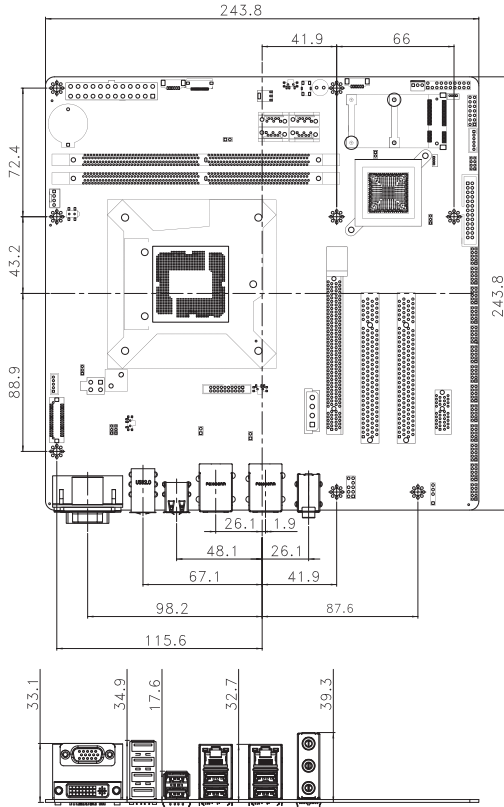

IMB-H810-i2-R11

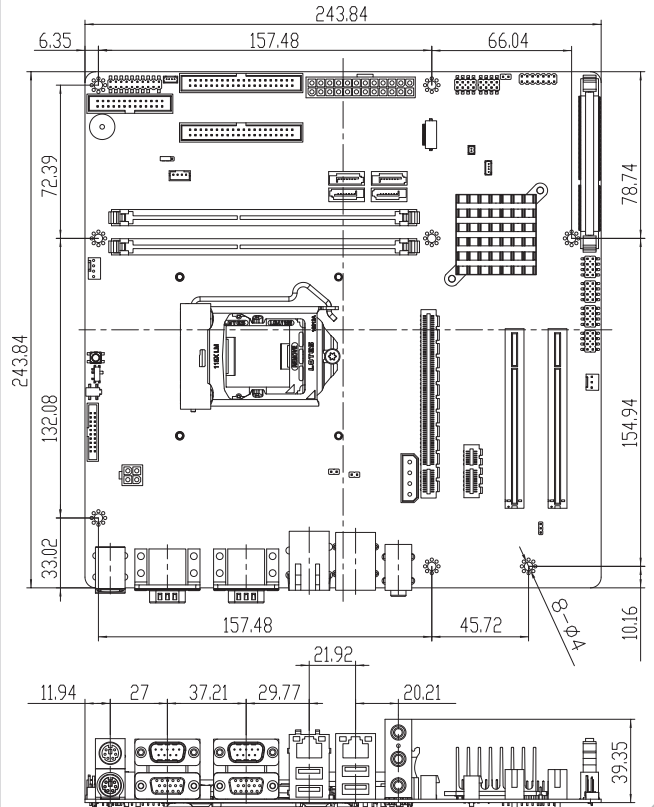

IMB-Q870-i2

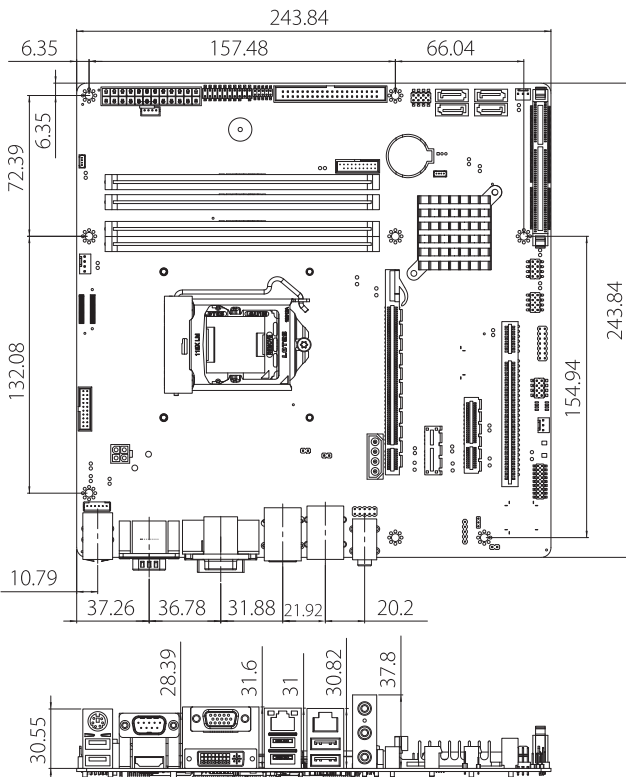

IMB-H610

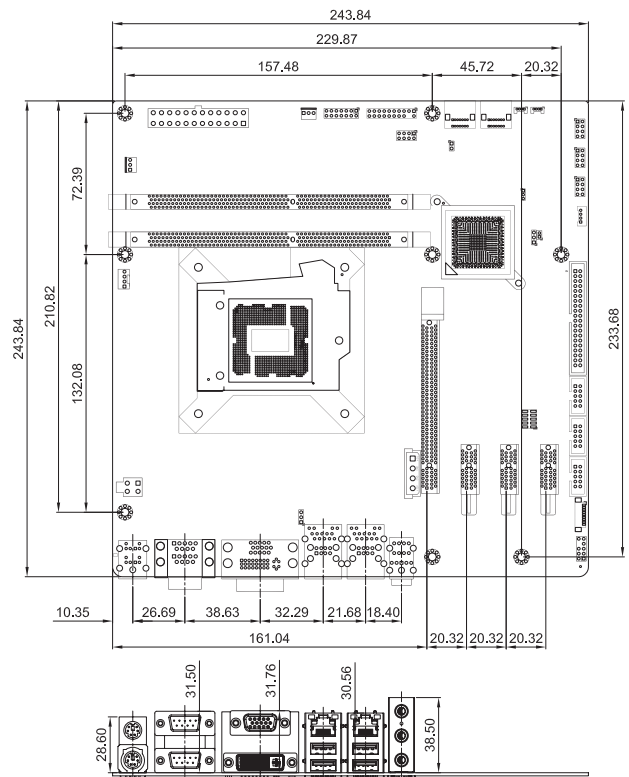

# Mini-ITX Selection Guide

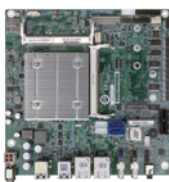
Model Name	KINO-DH310	tKINO-AL	gKINO-DMF	tKINO-ULT3	KINO-DCM236
<b>CPU Socket</b>	LGA1151	On Board	On Board	On Board	On Board
<b>CPU Type</b>	8th generation Intel® Core™ i7/ i5/i3 Pentium® and Celeron® processor	Intel® Atom™/Celeron®/ Pentium® on-board SoC	AMD G-series on board SoC Merlin Falcon	Intel® Core™ i7/i5/i3, Celeron® ULT processor	Intel® Xeon® E3, Core™ i3, Celeron® process
<b>Chipset</b>	Intel® H310	Intel® Atom™/Celeron®/ Pentium® on-board SoC	AMD G-series on board SoC Merlin Falcon	Intel® Core™ i7/i5/i3, Celeron® ULT processor	Intel® CM236
<b>Memory</b>	2 x 260-pin 2666/2400 MHz dual-channel DDR4 SDRAM SO-DIMMs (system Max. 64 GB)	2 x 204-pin 1866/1600 MHz single-channel DDR3L SO-DIMM (system max. 8 GB)	2 x SO-DIMM DDR4 2400MHz up to 64GB	2 x SO-DIMM DDR4 2133MHz, system maximum up to 32GB	2 x SO-DIMM DDR4 2133MHz up to 32GB with ECC support
<b>Display Interface</b>	Dual independent display 2 x HDMI 1 x iDP interface	Triple independent display 2 x DP++ 1 x eDP	Triple independent display 1 x HDMI 2.0 1 x HDMI 1.4 1 x DP++	Triple independent display 1 x HDMI/DP 1 x HDMI 1 x LVDS/eDP	Triple independent display 1 x HDMI 2.0 2 x HDMI 1.4 1 x LVDS
<b>Ethernet</b>	Dual LAN: RTL8111H	Dual LAN: RTL8111	Dual LAN: RTL8111GN	LAN1: Intel® I219LM LAN2: Intel® I211AT	LAN1: Intel® I219LM LAN2: Intel® I211
<b>iRIS Remote Management Module</b>	N/A				
<b>I/O Interface</b>	1 x KB/MS 1 x RS-422/485 3 x RS-232, 4 x USB 3.1 Gen 1 4 x USB 2.0	1 x PS/2 KB/MS 2 x RS-232/422/485 2 x USB 2.0 4 x RS-232 4 x USB 3.1 Gen 1	2 x RS-232/422/485 4 x RS-232 (2 support cctalk, TTL) 4 x USB 3.1 Gen 1 5 x USB 2.0	2 x RS-232/422/485 4 x RS-232 4 x USB 2.0 4 x USB 3.1 Gen 1	1 x KB/MS 2 x RS-232/422/485 4 x RS-232 4 x USB 2.0 4 x USB 3.1 Gen 1
<b>Storage Interface</b>	2 x SATA 6G/s	2 x SATA 6Gb/s with 12/5V SATA power connector 1 x M.2 (B Key) (2242)(SATA port1 + USB 2.0 signal) 1 x Micro SD slot (Optional)	2 x SATA 6Gb/s with 5V/12V SATA power connector 1 x MicroSD slot 1 x M.2 (B key) (SATA signal)	2 x SATA 6Gb/s with 5V SATA power connector 1 x eMMC5.0 (up to 32G, optional)	4 x SATA6Gb/s 1 x mSATA
<b>Audio</b>	Realtek ALC662 HD codec	Realtek ALC269 HD Audio codec	Realtek ALC662 HD Audio Codec		
<b>Digital I/O</b>	8-bit digital I/O	8-bit programmable digital I/O			
<b>Power Consumption</b>	12V@11.32A (Intel® Core™ i7-8700 up to 4.60 GHz CPU with two 8GB 2666MHz DDR4 memory)	12V@2.58A (Intel® Pentium® N4200 CPU with two 8GB 1600MHz DDR3L memory)	12V@5.54A (AMD RX-421BD 2.1GHz CPU with 2400 MHz 16GB DDR4 memory)	12V@4.68A (Intel® Core™ i7-6600U up to 3.4GHz CPU with 16GB (8GB x 2) DDR4-2133 memory running in 3.2GHz)	12V@6.93A (Intel Xeon E3-1505M V5 2.8GHz CPU with 32 GB (two 16 GB) 2133 MHz DDR4 memory)
<b>Watchdog Timer</b>	Software programmable and supports 1~255 sec. system reset				
<b>Operation Environment</b>	Temperature Range: -20°C ~ 70°C (-4°F ~ 158°F) Relative Humidity: 5% ~ 95% non-condensing		Temperature Range: -20°C ~ 60°C (-4°F ~ 140°F) Relative Humidity: 5% ~ 95% non-condensing		
<b>Expansion Slot</b>	1 x PCIe x16 1 x M.2 M key (2280, Gen2 PCIe x2 only) 1 x M.2 A Key (2230, PCIe x1 & USB 2.0)	1 x PCIe x1 slot 1 x Full/Half-size PCIe Mini card slot (w/ SIM holder)	1 x PCIe x8 slot 1 x Full-size PCIe Mini card slot 1 x MicroSD slot	1 x PCIe x4 slot 1 x Full-size PCIe Mini card slot (support mSATA, colay with SATA2) 1 x Full-size PCIe Mini card slot (with SIM card slot)	1 x PCIe x16 slot 1 x Full-size PCIe Mini card slot (support mSATA) 1 x Half-size PCIe Mini card slot 1 x M.2 2230 (A key)
<b>CPU Cooler</b>	CF-1156C-R20 CF-1156D-R20 CF-115XE-R10	Heatsink	Cooler	Heatsink	Heatsink



# Mini-ITX Selection Guide

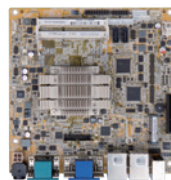

Model Name	KINO-DQM170	KINO-AQ170	tKINO-BW	KINO-DBT	KINO-DH810
<b>CPU Socket</b>	On board	LGA1151	On board	On board	LGA1150
<b>CPU Type</b>	6th generation Intel® Core™ i7/ i5/i3 and Celeron® processor	6th/7th generation Intel® Core™ i7/i5/i3, Pentium® and Celeron® processor	Intel® Pentium®/Celeron® on board SoC	Intel® Atom™/Celeron® on board SoC	Intel® Core™ i7/i5/i3, Pentium®, Celeron® processor
<b>Chipset</b>	Intel® QM170	Intel® Q170	Intel® Pentium®/Celeron® on-board SoC	Intel® Atom™/Celeron® on-board SoC	Intel® H81
<b>Memory</b>	Two 260-pin 2133 MHz dual-channel DDR4 SDRAM SO-DIMMs (system Max. 64 GB)	Two 260-pin 2133 MHz dual-channel DDR4 SDRAM SO-DIMMs (system Max. 64 GB)	Two 204-pin 1600/1333 MHz dual-channel DDR3L SDRAM SO-DIMMs (support up to 8 GB)	Two 204-pin 1066/1333 MHz dual-channel unbuffered DDR3L SDRAM SO-DIMM support up to 8 GB (J1900, N2930, E3845, E3827, E3826) One 204-pin 1066/1333 MHz dual-channel unbuffered DDR3L SDRAM SO-DIMM supports up to 4 GB (N2807, E3825, E3815)	Two 204-pin 1600/1333 MHz dual-channel DDR3 & DDR3L SDRAM unbuffered DIMMs (system max. 16 GB)
<b>Display Interface</b>	Triple independent display supported 1 x HDMI 2.0 2 x HDMI 1.4 1 x LVDS	Triple independent display supported 1 x HDMI 2.0 1 x HDMI/DP 1 x VGA 1 x iDP interface	Triple independent display supported 1 x HDMI/DP 1 x VGA 1 x 18/24-bit dual-channel LVDS	Dual independent display supported 1 x VGA 1 x DVI-D	Dual display supported 1 x VGA 1 x DVI-D 1 x iDP interface
<b>Ethernet</b>	LAN1: Intel® I219-LM with Intel® AMT 11.0 support LAN2: Intel® I211 PCIe controller	LAN1: Intel® I211 PCIe controller LAN2: Intel® I219LM with intel AMT 11.0 support	Dual LAN: Realtek RTL8111G PCIe controller	Dual LAN: Realtek RTL8111G PCIe controller	Dual LAN: Intel® I211-AT PCIe controller
<b>iRIS Remote Management Module</b>	N/A				
<b>I/O Interface</b>	1 x KB/MS 2 x RS-232/422/485 4 x RS-232 4 x USB 2.0 4 x USB 3.1 Gen 1	1 x KB/MS 2 x RS-232/422/485 4 x RS-232 4 x USB 3.1 Gen 1 6 x USB 2.0	1 x KB/MS 2 x RS-232/422/485 2 x USB 3.1 Gen 1 4 x RS-232 4 x USB 2.0	1 x KB/MS 1 x RS-422/485 2 x USB 3.1 Gen 1 4 x USB 2.0 5 x RS-232	1 x PS/2 for KB/MS 1 x RS-422/485 2 x USB 3.1 Gen 1 5 x RS-232 6 x USB 2.0
<b>Storage Interface</b>	4 x SATA 6Gb/s (RAID 0/1/5/10 supported)	4 x SATA 6Gb/s (RAID 0/1/5/10 supported)	2 x SATA 6Gb/s 1 x mSATA 1 x Micro SD slot	2 x SATA 3Gb/s 1 x Micro SD slot (E38xx sku only)	2 x SATA 6Gb/s
<b>Audio</b>	Realtek ALC662 HD Audio codec				
<b>Digital I/O</b>	8-bit digital I/O				8-bit programmable digital I/O
<b>Power Consumption</b>	12V@5.08A (Intel® Core™ i7-6820EQ, 3.5GHz CPU with 16 GB (two 8 GB) 2133 MHz DDR4 memory)	3.3V@1.62A, 5V@3.54A, 12V@8.17A, 5VSB@3.6A (Intel® Core™ i7 6700K 4.0 GHz CPU with 16 GB (two 8 GB) 2133 MHz DDR4 memory)	12V@1.61A (Intel® Celeron® N3710 CPU with two 4 GB 1600 MHz DDR3L memory)	12V@1.64A (Intel® Celeron® J1900 CPU with 4 GB 1333 MHz DDR3L memory)	12V@6.03A (Intel® Core™ i7-4770K 3.90 GHz CPU with two 1333 MHz 4 GB DDR3 memory)
<b>Watchdog Timer</b>	Software programmable supports 1~255 sec. system reset				
<b>Operation Environment</b>	Temperature Range: -20°C ~ 60°C (-4°F ~ 140°F) Relative Humidity: 5% ~ 95%, non-condensing				
<b>Expansion Slot</b>	1 x PCIe x16 slot 1 x Full-size PCIe Mini card slot (support mSATA) 1 x Half-size PCIe Mini card slot 1 x M.2 2230 (A key)	1 x PCIe x8 slot 1 x Full-size PCIe Mini card Slot (support mSATA)	1 x PCIe x1 slot 1 x PCIe Mini card slot	1 x Full-size PCIe Mini card slot (support mSATA) 1 x PCIe x4 slot (with PCIe x1 signal)	1 x Full-size PCIe Mini card slot 1 x PCIe x1 slot
<b>CPU Cooler</b>	Heatsink	CF-1156C-R20 CF-1156D-R20 CF-115XE-R10	Heatsink	Heatsink	CF-115XA-R10 CF-115XE-R10

# Mini-ITX Selection Guide

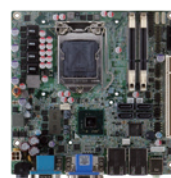

Model Name	eKINO-BT	KINO-DQM871-11	KINO-QM770	KINO-DH610	KINO-AH612
<b>CPU Socket</b>	On board	On Board	Socket G2	Socket H2	Socket H2
<b>CPU Type</b>	Intel® Atom™/Celeron® on-board SoC	Intel® Core™ i7/i5/i3 Mobile processor	Intel® Mobile processor	Intel® Core™ i3, Pentium®, Celeron® processor	Intel® Core™ i7/i5/i3, Pentium®, Celeron® processor
<b>Chipset</b>	Intel® Atom™/Celeron® on-board SoC	Intel® QM87	Intel® QM77	Intel® H61	Intel® H61
<b>Memory</b>	Two 204-pin 1066/1333 MHz dual-channel unbuffered DDR3L SDRAM SO-DIMM support up to 8 GB (J1900, N2930, E3845, E3827, E3826) One 204-pin 1066/1333 MHz dual-channel unbuffered DDR3L SDRAM SO-DIMM supports up to 4 GB (N2807, E3825, E3815)	2 x 204-pin, Max. 16 GB, 1333/1600 MHz dual-channel DDR3 SO-DIMMs	2 x 204-pin, Max. 16 GB, 1066/1333/1600 MHz dual-channel DDR3 SO-DIMMs	2 x 204-pin 1066/1333 MHz dual-channel DDR3 SO-DIMMs (system max. 16 GB)	2 x 204-pin 1066/1333 MHz dual-channel DDR3 SO-DIMMs (system max. 16 GB)
<b>Display Interface</b>	Dual display supported 1 x VGA 2 x 18/24-bit dual-channel LVDS	Triple display supported 2 x HDMI 1 x VGA 1 x 18/24-bit dual-channel LVDS 1 x iDP interface	Triple display supported 2 x HDMI 1 x DVI-I 1 x 18/24-bit dual-channel LVDS	Dual display supported 1 x VGA 1 x HDMI 1 x DVI-D	Dual display supported 1 x VGA 1 x DVI-D
<b>Ethernet</b>	Dual LAN: Realtek RTL8111E PCIe controller	LAN1: Intel® I217LM with Intel® AMT 9.0 support LAN2: Intel® I210-AT PCIe controller	LAN1: Intel® 82579 PHY with Intel® AMT 8.0 support LAN2: Intel® 82583V PCIe controller	LAN1: Realtek RTL8111E PCIe GbE controller with ASF 2.0 support LAN2: Realtek RTL8111E PCIe GbE controller	Dual LAN: Realtek RTL8111E PCIe GbE controller with ASF 2.0 support
<b>iRIS Remote Management Module</b>	N/A	1 x iRIS-1010 slot	N/A		
<b>I/O Interface</b>	1 x PS/2 for KB/MS 1 x RS-422/485 2 x USB 3.1 Gen 1 4 x RS-232 4 x USB 2.0	1 x PS/2 for KB/MS 1 x RS-422/485 1 x SMBus 1 x TPM (2x10 pin) 4 x USB 3.1 Gen 1 5 x RS-232 10 x USB 2.0	1 x KB/MS 1 x RS-422/485 1 x SMBus 1 x TPM (2x10 pin) 2 x RS-232 4 x USB 2.0 4 x USB 3.1 Gen 1	1 x KB/MS 1 x RS-232 1 x RS-422/485 1 x TPM (2x10 pin) 10 x USB 2.0	1 x PS/2 for KB/MS 1 x RS-422/485 1 x TPM (2x10 pin) 5 x RS-232 8 x USB 2.0
<b>Storage Interface</b>	2 x SATA 3Gb/s	2 x SATA 6Gb/s 2 x SATA 3Gb/s 1 x mSATA	2 x SATA 6Gb/s 2 x SATA 3Gb/s	4 x SATA 3Gb/s	4 x SATA 3Gb/s
<b>Audio</b>	Realtek ALC662 HD Audio codec		Realtek ALC892 HD Audio codec	Realtek ALC662 HD Audio codec	
<b>Digital I/O</b>	8-bit programmable digital I/O				
<b>Power Consumption</b>	12V@1.55A (Intel® Celeron® J1900 CPU with two 8 GB 1333 MHz DDR3L memory)	12V@5.03A (2.0GHz Intel® Core™ i7 processor with two 1333 MHz 4 GB DDR3 memory)	12V@6.08A (2.3GHz Intel® Core™ i7-3610QE with two 1333 MHz 4 GB DDR3 memory running 3DMark06 burn in)	12V@5.07A (2.2GHz Intel® G620T with two 2GB DDR3 1066 MHz running 3DMark06 burn in) 12V@8.85A (2.8GHz Intel® Core™ i7-2600S with two 1066 MHz 2 GB DDR3 running 3DMark06 burn in)	5V@3.9A, 12V@0.36A, Vcore_12V@8.28A, 3.3V@1.24A, 5VSB@0.18A (3.4GHz Intel® Core™ i7-2600 with two 1333 MHz 2 GB DDR3)
<b>Watchdog Timer</b>	Software programmable and supports 1~255 sec. system reset				
<b>Operation Environment</b>	Temperature Range: 0°C ~ 60°C (32°F ~ 140°F) Relative Humidity: 5% ~ 95% non-condensing		Temperature Range: -10°C ~ 60°C (14°F ~ 140°F) Relative Humidity: 5% ~ 95%, non-condensing		
<b>Expansion Slots</b>	1 x Full-size PCIe Mini card slot 1 x PCIe x1 slot	1 x PCIe x16 slot 1 x Full-size PCIe Mini slot (support mSATA)	1 x PCIe x16 slot 1 x PCIe Mini card slot (support mSATA)	1 x PCI slot 1 x PCIe x1 slot	1 x PCIe x4 slot
<b>CPU Cooler</b>	Heatsink	XCF-479B-RS CF-989B-RS-R11	CF-989A-RS-R12	CF-115XA-R10 CF-1156C-R20 CF-1156D-R20 CF-115XE-R10	CF-115XA-R10 CF-1156C-R20 CF-1156D-R20 CF-115XE-R10







# gKINO-DMF

Mini-ITX SBC supports AMD Merlin Falcon SoC Processor, HDMI 2.0, M.2, PCIe Mini, SATA 6Gb/s, USB 3.1 Gen 1 (5Gb/s), HD audio and RoHS

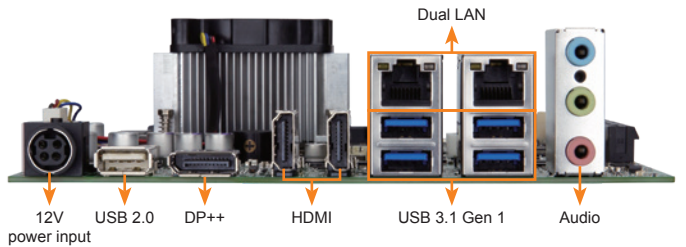
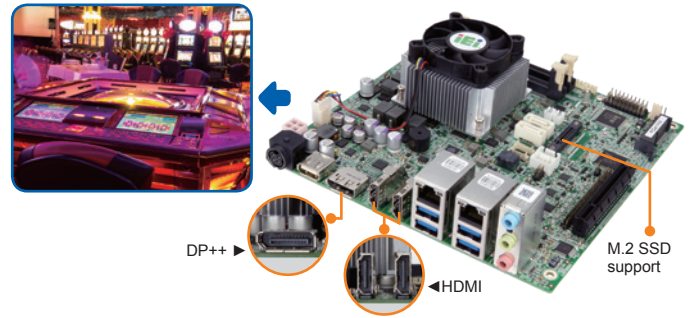
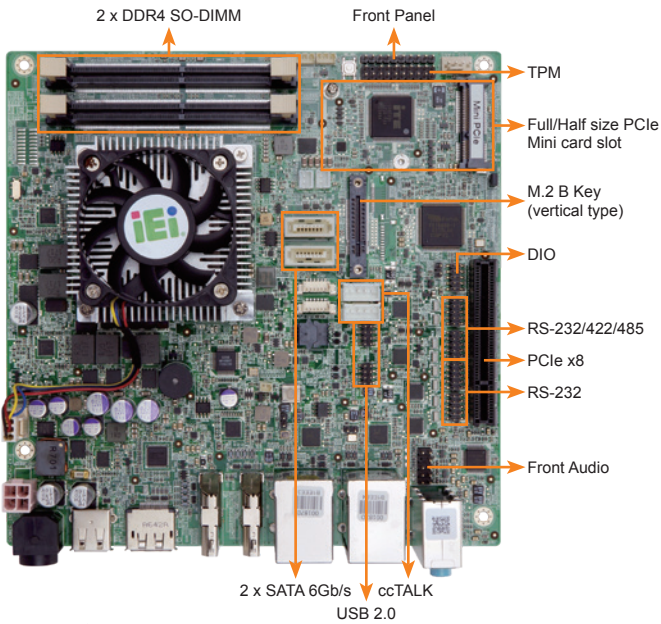

## Specifications

- ◆ SoC
  - FP4 BGA supports AMD Merlin Falcon SoC
  - RX-421BD on-board SoC (2.1GHz, quad-core, 2MB cache, TDP=35W)
  - RX-216GD on-board SoC (1.6GHz, quad-core, 1MB cache, TDP=15W)
- ◆ BIOS
  - UEFI BIOS
- ◆ Memory
  - Two 260-pin 2400MHz dual-channel DDR4 non-ECC unbuffered SO-DIMMs support up to 64 GB
- ◆ Graphics Engine
  - AMD Radeon HD 10000graphic,3rd Gen. graphic core,support DX 12, HSA 2.0
  - UVD v6 decode for H.265 MPEG2/4, VC-1, MVC
  - VCE v3.1 encode for H.254 VCE
- ◆ Display Output
  - Triple independent display
  - 2 x HDMI 1.4 (up to 4096x2160@24Hz)
  - 1 x DP++ (up to 3840x2160@60Hz)
- ◆ Ethernet
  - Dual GbE RTL 8111GN
- ◆ External I/O Interface
  - 4 x USB 3.1 Gen 1 (5Gb/s)
  - 1 x USB 2.0
- ◆ Internal I/O Interface
  - 1 x MicroSD card slot
  - 2 x RS-232 (2x5 pin, P=2.0)
  - 2 x RS-232 (support Cctalk, TTL)(1x4 pin, P=2.54)
  - 4 x USB 2.0 (2x4 pin, P=2.0)
  - 2 x SATA with 5V/12V output
- ◆ Audio
  - Realtek ALC662 HD audio codec
  - 3 x Audio jacks (line-out, line-in, mic-in) on rear IO
  - 1 x Front audio (2x5-pin)
- ◆ Front Panel
  - 1 x Front panel (2x7 pin, power LED, HDD LED, speaker, power button, reset button)
- ◆ LAN LED
  - 2 x LAN LED (1x2 pin)
- ◆ SMBUS
  - 1 x SMBus (1x4 pin)
- ◆ I<sup>2</sup>C
  - 1 x I<sup>2</sup>C (1x4 pin)
- ◆ TPM
  - 1 x TPM (2x10 pin)
- ◆ Digital I/O: 8-bit digital I/O (2x5 pin)
- ◆ Expansion
  - 1 x PCIe x 8 slot
  - 1 x Full size PCIe Mini card slot
- ◆ Watchdog Timer: Software programmable, supports 1~255 sec. system reset
- ◆ Chassis Intrusion Detection: 1 x Chassis intrusion connector (1x2 pin)
- ◆ Power Supply
  - 12V DC input
  - 1 x Internal power connector (2x2 pin)
  - Support AT/ATX mode
  - 1 x External DC jack (4-pin DIN)
- ◆ FAN Connector
  - 1 x CPU smart fan (1x4 pin)
  - 1 x System smart fan (1x4 pin)
- ◆ Power Consumption
  - 12V@5.54A (AMD RX-421BD 2.1GHz CPU with 2400 MHz 16GB DDR4 memory)
- ◆ Storage Temperature: -10°C ~ 70°C
- ◆ Operating Temperature: 0°C ~ 60°C
- ◆ Operating Humidity: 5% ~ 95%, non-condensing
- ◆ Dimensions: 170mm x 170 mm
- ◆ Weight: GW: 1100g / NW: 700g
- ◆ CE/FCC compliant



## Features

- Mini ITX form factor with AMD Merlin Falcon processor supports dual-channel DDR4 SO-DIMMs
- Triple independent display support via dual HDMI and DP++
- Full size PCIe Mini slot and vertical type M.2 B key slot for expansion
- COM, Cctalk, TTL, and USB 3.1 Gen 1 (5Gb/s) support
- IEI one key recovery solution allows you to create rapid OS backup and recovery

## Packing List

- 1 x gKINO-DMF single board computer with CPU cooler
- 1 x SATA cable
- 1 x I/O shielding
- 1 x QIG

## Ordering Information

Part No.	Description
gKINO-DMF-421-R10	Mini-ITX SBC supports AMD RX-421BD on board SoC (quad-core 2.1GHz, 35W), DDR4 ,triple independent displays,HDMI/DP, dual GbE, SATA 6Gb/s, USB3.0, PCIe Mini, M.2,HD audio and RoHS
gKINO-DMF-216-R10	Mini-ITX SBC supports AMD RX-216GD on board SoC (dual-core 1.6GHz, 15W), DDR4 ,triple independent displays, HDMI/DP, dual GbE, SATA 6Gb/s, USB3.0, PCIe Mini, M.2, HD audio and RoHS
19800-000300-100-RS	RS-232 cable with bracket, 300mm, P=2.0
CB-USB02A-RS	Dual-port USB cable with bracket, 300mm, P=2.0
TPM-IN01-R20	20-pin Infineon TPM module, software management tool, firmware v3.17



# tKINO-ULT3

Thin Mini-ITX SBC supports Intel® Skylake-U Processor, 9~36V DC input, Dual HDMI, LVDS, SATA 6Gb/s, Dual Intel® GbE, USB 3.1 Gen 1 (5Gb/s), PCIe Mini, eMMC 5.0, HD audio and RoHS

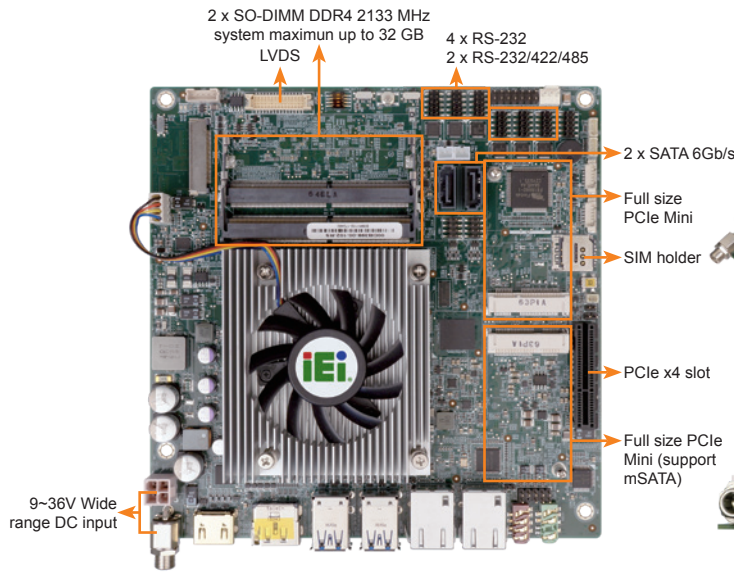

Multiple expansion with COM port, PCIe x4, and PCIe Mini.

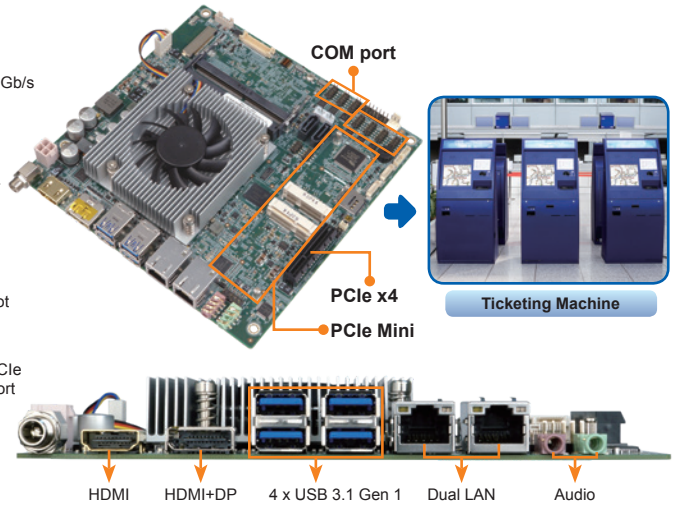

## Specifications

- ◆ CPU
  - 6th generation Intel® mobile ULT on-board processor
  - Intel® Core™ i7-6600U (up to 3.4GHz, dual-core, 4M Cache, TDP=15W)
  - Intel® Core™ i5-6300U (up to 3.0GHz, dual-core, 3M Cache, TDP=15W)
  - Intel® Core™ i3-6100U (up to 2.3GHz, dual-core, 3M Cache, TDP=15W)
  - Intel® Celeron® 3955U (up to 2.0GHz, dual-core, 2M Cache, TDP=15W)
  - Intel® Celeron® 3855U (up to 1.6GHz, dual-core, 2M Cache, TDP=15W)
- ◆ BIOS
  - UEFI BIOS
- ◆ Memory
  - 2 x SO-DIMM DDR4 2133MHz, system maximum up to 32GB
- ◆ Graphics Engine
  - Intel® HD graphic
- ◆ Display Output
  - 1 x HDMI 1.4 (up to 4096x2160@24Hz)
  - 1 x HDMI/DP (up to 4096x2160@24Hz)
  - 1 x LVDS/eDP (select by switch)
- ◆ Ethernet
  - LAN1: Intel® I219LM (with Intel® AMT11.0 support)
  - LAN2: Intel® I211AT PCIe controller with NCSI support
- ◆ External I/O Interface
  - 4 x USB 3.1 Gen 1 (5Gb/s)
- ◆ Internal I/O Interface
  - 1 x eMMC 5.0 (optional, up to 32G)
  - 4 x RS-232 (2x5 pin, P=2.0)
  - 2 x RS-232/422/485 (2x5 pin, P=2.0)
  - 4 x USB 2.0 (2x4 pin, P=2.0)
  - 2 x SATA with 5V output
- ◆ Audio
  - Realtek ALC662 HD Audio Codec support 5.1 Channel
  - 2 x Audio jacks (line-out, mic-in) on rear IO
  - 1 x Front audio (2x5-pin)
- ◆ Front Panel
  - 1 x Front panel (2x7 pin, power LED, HDD LED, power button, reset button)
- ◆ LAN LED
  - 2 x LAN LED(1x2 pin)
- ◆ SMBUS: 1 x SMBus (1x4 pin)
- ◆ I<sup>2</sup>C: 1 x I<sup>2</sup>C (1x4 pin)
- ◆ Digital I/O: 8-bit digital I/O (2x5 pin)
- ◆ Expansion
  - 1 x PCIe x4 slot
  - 1 x Full-size PCIe Mini card slot (support mSATA, colay SATA2)
  - 1 x Full-size PCIe Mini card slot (with SIM holder)
  - \*3855U belongs to Skylake ULT Base series CPU, PCIe signal support only PCIe Gen 2*
- ◆ Watchdog Timer
  - Software programmable, supports 1~255 sec. system reset by Super I/O
- ◆ Power Supply
  - 9~36V DC input
  - 1 x Internal power connector (2x2 pin)
  - 1 x External DC power Jackc (Ø5.5mm)
  - Support AT/ATX mode
- ◆ Fan Connector
  - 1 x CPU smart fan (1x4 pin)
  - 1 x System fan (1x3 pin)
- ◆ Chassis Intrusion Detection: 1 x Chassis intrusion connector (1x2 pin)
- ◆ Power Consumption
  - 12V@4.68A (Intel® Core™ i7-6600U up to 3.4GHz CPU with 16GB (8GB x 2) DDR4-2133 memory running in 3.2GHz)
- ◆ Operating Temperature: -20°C ~ 60°C
- ◆ Operating Humidity: 5% ~ 95%, non-condensing
- ◆ Dimensions: 170mm x 170 mm
- ◆ Weight: GW: 900g / NW: 375g
- ◆ CE/FCC compliant



## Features

- Mini ITX form factor with Intel® Skylake-U processor support DDR4-2133 memory
- Wide range 9~36V DC Input
- Support dual HDMI (one HDMI/DP combo support), LVDS/eDP
- Intel® GbE LAN with Intel® AMT 11.0 supported
- SATA 6Gb/s, mSATA and eMMC 5.0 (option) supported
- High speed I/O for USB 3.1 Gen 1 (5Gb/s), PCIe x4, full-size PCIe Mini support

## Packing List

1 x tKINO-ULT3 single board computer with CPU cooler
2 x SATA cable
1 x I/O shielding
1 x QIG

## Ordering Information

Part No.	Description
tKINO-ULT3-i7-R10	Thin Mini-ITX SBC supports Intel® 6th Generation Mobile Core™ i7-6600U (15W) on-board Processor (ULT), 9~36V DC input, Dual HDMI, LVDS, eDP, SATA 6 Gb/s, Dual Intel® GbE, PCIe Mini, USB 3.1 Gen 1 (5Gb/s), eMMC 5.0, HD audio and RoHS
tKINO-ULT3-i5-R10	Thin Mini-ITX SBC supports Intel® 6th Generation Mobile Core™ i5-6300U (15W) on-board processor (ULT), 9~36V DC input, Dual HDMI, LVDS, eDP, SATA 6 Gb/s, Dual Intel® GbE, PCIe Mini, USB 3.1 Gen 1 (5Gb/s), eMMC 5.0, HD audio and RoHS
tKINO-ULT3-i3-R10	Thin Mini-ITX SBC supports Intel® 6th Generation Mobile Core™ i3-6100U (15W) on-board processor (ULT), 9~36V DC input, Dual HDMI, LVDS, eDP, SATA 6 Gb/s, Dual Intel® GbE, PCIe Mini, USB 3.1 Gen 1 (5Gb/s), eMMC 5.0, HD audio and RoHS
tKINO-ULT3-C-R10	Thin Mini-ITX SBC supports Intel® 6th Generation Mobile Celeron® 3955U (15W) on-board processor (ULT), 9~36V DC input, Dual HDMI, LVDS, eDP, SATA 6 Gb/s, Dual Intel® GbE, PCIe Mini, USB 3.1 Gen 1 (5Gb/s), eMMC 5.0, HD audio and RoHS
tKINO-ULT3-CE-R10	Thin Mini-ITX SBC supports Intel® 6th Generation Mobile Celeron® 3855U (15W) on-board processor (ULT), 9~36V DC input, Dual HDMI, LVDS, eDP, SATA 6 Gb/s, Dual Intel® GbE, PCIe Mini, USB 3.1 Gen 1 (5Gb/s), eMMC 5.0, HD audio and RoHS
32205-002700-200-RS	RS-232/422/485, 200mm, P=2.0
34000-000645-RS	Fanless heatsink module, 93.5 x 84 x 30mm



# KINO-DCM236

Mini-ITX SBC supports 6th Intel® Xeon® Processor E3 v5 series, Core™ i3, Celeron® per Intel® CM236, DDR4 with ECC support, HDMI 2.0, dual Intel® GbE, SATA 6Gb/s, USB 3.1 Gen 1 (5Gb/s), PCIe Mini, M.2, HD Audio and RoHS

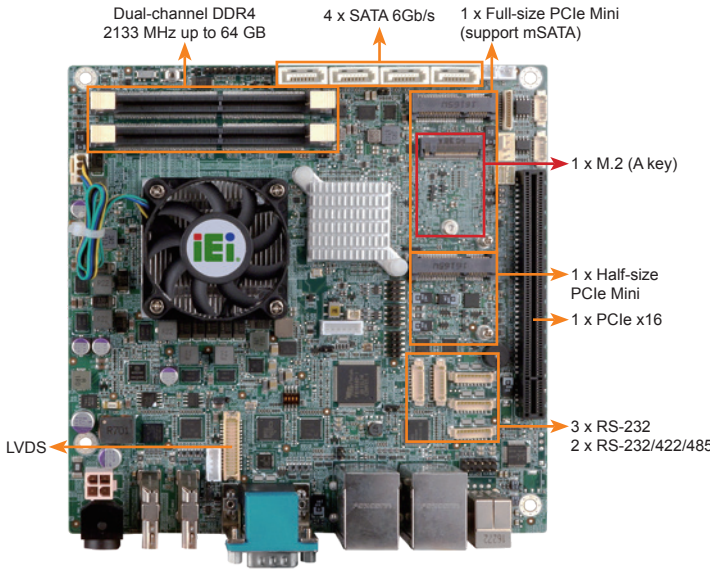

## Flexible Selection of Modules with Different Functions

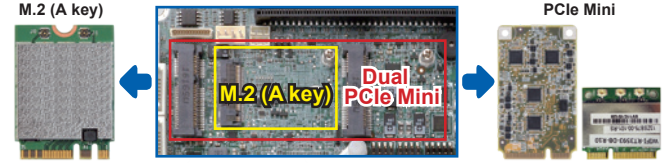

## SO-DIMM DDR4 ECC support



## Specifications

- ◆ CPU
  - 6th generation Intel® processor
  - Intel® Xeon® processor E3-1505M v5 (up to 3.7GHz, quad-core, 8M Cache, TDP=45W)
  - Intel® Xeon® processor E3-1505L v5 (up to 2.0GHz, quad-core, 8M Cache, TDP=25W)
  - Intel® Core™ i3-6102E processor (up to 1.90GHz, dual-core, 3M cache, TDP=25W)
  - Intel® Celeron® processor G3902E (up to 1.60GHz, dual-core, 2M cache, TDP=25W)
- ◆ Chipset: Intel® CM236
- ◆ BIOS: UEFI BIOS
- ◆ Memory
  - Two 260-pin 2133/1866 MHz dual-channel DDR4 ECC and non-ECC unbuffered SDRAM SO-DIMMs support up to 64GB
- ◆ Graphics Engine
  - Intel® HD Graphics Gen 9 support for DX11/12, OCL 2.x, OGL 4.3/4.4, ES 2.0
- ◆ Display Output
  - Triple independent display
  - 2 x HDMI 1.4 (up to 4096x2160@24Hz)
  - 1 x HDMI 2.0 (up to 4096x2160@60Hz)
  - 1 x 18/24-bit dual-channel LVDS (up to 1920x1200@60Hz)
- ◆ Ethernet
  - LAN1: Intel® I219LM with (Intel® AMT 11.0 support)
  - LAN2: Intel® I211 PCIe controller with NCSI support
- ◆ External I/O Interface
  - 4 x USB 3.1 Gen 1 (5Gb/s) 1 x RS-232
- ◆ Internal I/O Interface
  - 1 x KB/MS (1x6 pin, P=2.0) 4 x SATA 6Gb/s (RAID 0/1/5/10 support)
  - 2 x RS-232/422/485 (1x9 pin, P=1.25) 4 x USB 2.0 (2x4 pin, P=2.0)
  - 3 x RS-232 (1x9 pin, P=1.25)
- ◆ Audio
  - Realtek ALC662 HD Audio codec supports 5.1-channel
  - 2 x Audio jacks (line-out, mic-in) on rear IO
  - 1 x Front audio (2x5-pin)
- ◆ Front Panel
  - 1 x Front panel (2x7 pin, power LED, HDD LED, speaker, power button, reset button)
- ◆ LAN LED: 2 x LAN LED (1x2 pin)
- ◆ SMBus: 1 x SMBus (1x4 pin)
- ◆ I<sup>2</sup>C: 1 x I<sup>2</sup>C (1x4 pin)
- ◆ Digital I/O: 8-bit digital I/O (2x5 pin)
- ◆ Expansion
  - 1 x PCIe x16 slot 1 x Full-size PCIe Mini card slot (support mSATA)
  - 1 x M.2 2230 (A key) 1 x Half-size PCIe Mini card slot
- ◆ Cooler Module
  - 19100-000219-00-RS for Intel® Xeon® E3-1505M v5 (45W)
  - 19100-000203-00-RS for Intel® Xeon® E3-1505L v5/Core™ i3/Celeron® (25W)
- ◆ Watchdog Timer
  - Software programmable supports 1~255 sec. system reset by super I/O
- ◆ Chassis Intrusion Detection: 1 x Chassis intrusion connector (1x2 pin)
- ◆ Power Supply
  - 12V DC input
  - 1 x External DC jack (4-pin DIN)
  - 1 x Internal power connector (2x2 pin)
  - Support AT/ATX mode
- ◆ Fan Connector
  - 1 x CPU smart (1x4 pin) 1 x System fan (1x4 pin)
- ◆ Power Consumption
  - 12V@6.93A (Intel Xeon E3-1505M V5 2.8GHz CPU with 32 GB (two 16 GB) 2133 MHz DDR4 memory)
- ◆ Operating Temperature: -20°C ~ 60°C
- ◆ Operating Humidity: 5% ~ 95%, non-condensing
- ◆ Dimensions: 170mm x 170 mm
- ◆ Weight: GW: 900g / NW: 450g
- ◆ CE/FCC compliant

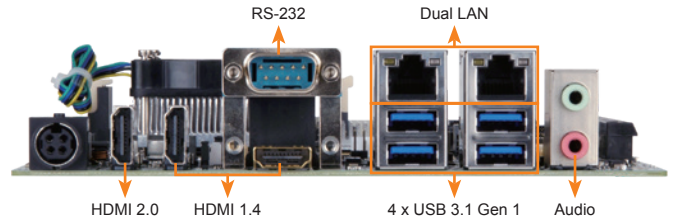

## Features

- Mini ITX form factor with 6th Intel® Xeon® Processor E3 v5 series, Core™ i3, Celeron® support DDR4-2133 memory with ECC support
- HDMI 2.0
- ECC support
- Triple display with independent audio
- PCIe x16, dual PCIe Mini and M.2 A key feature support for various function module
- Rich High speed I/O interface for USB 3.1 Gen 1 (5Gb/s) and SATA 6Gb/s
- Support IEI jumpless

## Packing List

1 x KINO-DCM236 single board computer with CPU cooler	2 x SATA cable
1 x I/O shielding	1 x QIG

## Ordering Information

Part No.	Description
KINO-DCM-236-E3-R10	Mini-ITX SBC supports 6th Intel® Xeon® processor E3-1505M v5 (45W), DDR4 with ECC support, HDMI 2.0, SATA 6Gb/s, dual Intel® GbE, USB 3.1 Gen 1 (5Gb/s), PCIe Mini, M.2, HD Audio and RoHS
KINO-DCM-236-E3E-R10	Mini-ITX SBC supports 6th Intel® Xeon® processor E3-1505L v5 (25W), DDR4 with ECC support, HDMI 2.0, SATA 6Gb/s, dual Intel® GbE, USB 3.1 Gen 1 (5Gb/s), PCIe Mini, M.2, HD Audio and RoHS
KINO-DCM-236-i3E-R10**	Mini-ITX SBC supports 6th Intel® Core™ i3-6102E processor (25W), DDR4 with ECC support, HDMI 2.0, SATA 6Gb/s, dual Intel® GbE, USB 3.1 Gen 1 (5Gb/s), PCIe Mini, M.2, HD Audio and RoHS
KINO-DCM-236-CE-R10**	Mini-ITX SBC supports 6th Intel® Celeron® processor G3902E (25W), DDR4 with ECC support, HDMI 2.0, SATA 6Gb/s, dual Intel® GbE, USB 3.1 Gen 1 (5Gb/s), PCIe Mini, M.2, HD Audio and RoHS
32000-023800-RS	PS/2 KB/MS cable, 135mm/110mm, P=2.0
32001-008600-200-RS	Dual-port USB cable, 210mm, P=2.0
32005-000900-200-RS	RS-232/422/485 cable, 100mm, P=1.25

\*\*By order production, MOQ: 100

# KINO-DQM170

Mini-ITX SBC supports 6th Intel® Core™ Mobile CPU, HDMI 2.0, M.2, SATA 6Gb/s, dual Intel® GbE, USB 3.1 Gen 1 (5Gb/s), PCIe Mini, HD Audio and RoHS

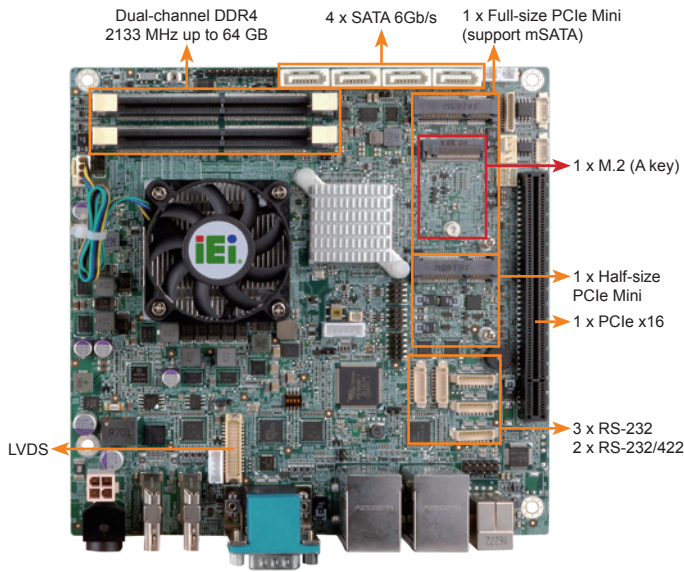

## Flexible Selection of Modules with Different Functions

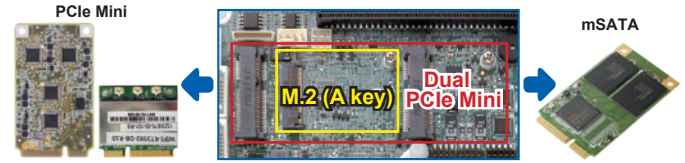

## Triple Independent Displays

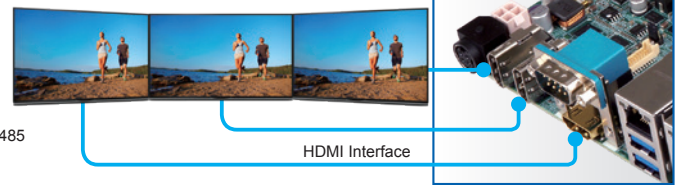

## Specifications

- CPU**
  - 6th generation Intel® Core™ mobile processor
  - Intel® Core™ i7-6820EQ (up to 3.5GHz, quad-core, 8M cache, TDP=45W)
  - Intel® Core™ i5-6440EQ (up to 3.4GHz, quad-core, 6M cache, TDP=45W)
  - Intel® Core™ i3-6102E (up to 1.90GHz, dual-core, 3M cache, TDP=25W)
  - Intel® Celeron® G3902E (up to 1.60GHz, dual-core, 2M cache, TDP=25W)
- Chipset:** Intel® QM170
- BIOS:** UEFI BIOS
- Memory**
  - Two 260-pin 2133/1866 MHz dual-channel unbuffered DDR4 SDRAM SO-DIMMs support up to 64GB
- Graphics Engine**
  - Intel® HD Graphics Gen 9 support for DX11/12, OCL 2.x, OGL 4.3/4.4, ES 2.0
- Display Output**
  - Triple independent display
  - 2 x HDMI 1.4 (up to 4096x2160@24Hz)
  - 1 x HDMI 2.0 (up to 4096x2160@60Hz)
  - 1 x 18/24-bit dual-channel LVDS (up to 1920x1200@60Hz)
- Ethernet**
  - LAN1: Intel® I219LM with (Intel® AMT 11.0 support)
  - LAN2: Intel® I211 PCIe controller with NCSI support
- External I/O Interface**
  - 4 x USB 3.1 Gen 1 (5Gb/s)
  - 1 x RS-232
- Internal I/O Interface**
  - 1 x KB/MS (1x6 pin, P=2.0)
  - 4 x SATA 6Gb/s (RAID 0/1/5/10 support)
  - 2 x RS-232/422/485 (1x9 pin, P=1.25)
  - 4 x USB 2.0 (2x4 pin, P=2.0)
  - 3 x RS-232 (1x9 pin, P=1.25)
- Audio**
  - Realtek ALC662 HD Audio codec supports 5.1-channel
  - 2 x audio jacks(line out, mic in) on rear I/O (colay with 3x audio jack)
  - 1 x Front audio (2x5 pin)
- Front Panel**
  - 1 x Front panel (2x7 pin, power LED, HDD LED, speaker, power button, reset button)
- LAN LED:** 2 x LAN LED (1x2 pin)
- SMBus:** 1 x SMBus (1x4 pin)
- I<sup>2</sup>C:** 1 x I<sup>2</sup>C (1x4 pin)
- Digital I/O:** 8-bit digital I/O (2x5 pin)
- Expansion**
  - 1 x PCIe x16 slot
  - 1 x Full-size PCIe Mini card slot (support mSATA)
  - 1 x M.2 2230 (A key)
  - 1 x Half-size PCIe Mini card slot
- Cooler Module**
  - 19100-000219-00-RS for Intel® Core™ i7/i5 (45W)
  - 19100-000203-00-RS for Intel® Core™ i3/Celeron® (25W)
- Watchdog Timer**
  - Software programmable supports 1~255 sec. system reset by super I/O
- Chassis Intrusion Detection:** 1 x Chassis intrusion connector (1x2 pin)
- Power Supply**
  - 12V DC input
  - 1 x External DC jack (4-pin DIN)
  - 1 x Internal power connector (2x2 pin)
  - Support AT/ATX mode
- Fan Connector**
  - 1 x CPU smart (1x4 pin)
  - 1 x System fan (1x4 pin)
- Power Consumption**
  - 12V@5.08A (Intel® Core™ i7-6820EQ, 3.5GHz CPU with 16 GB (two 8 GB) 2133 MHz DDR4 memory)
- Operating Temperature:** -20°C ~ 60°C
- Operating Humidity:** 5% ~ 95%, non-condensing
- Dimensions:** 170mm x 170 mm
- Weight:** 900g / NW: 450g
- CE/FCC compliant**

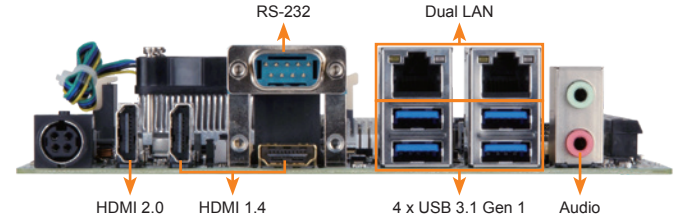

## Features

- Mini ITX form factor with 6th Gen Intel® Core™ i7/i5/i3/Celeron® processor support
- DDR4 memory
- Support HDMI 2.0 (4096x2160@60Hz)
- Triple display with independent audio via HDMI
- PCIe x16, dual PCIe Mini and M.2 A key feature support for various function module
- Rich High speed I/O interface for USB 3.1 Gen 1 (5Gb/s) and SATA 6Gb/s
- Support IEI jumpless

## Packing List

1 x KINO-DQM170 single board computer with CPU cooler	2 x SATA cable
1 x I/O shielding	1 x QIG

## Ordering Information

Part No.	Description
KINO-DQM170-i7-R10	Mini-ITX SBC with BGA 1440 supports 6th Gen Intel® Core™ i7-6820EQ processor, HDMI 2.0, SATA 6Gb/s, dual Intel® GbE, USB 3.1 Gen 1 (5Gb/s), PCIe Mini, M.2, HD Audio and RoHS
KINO-DQM170-i5-R10	Mini-ITX SBC with BGA 1440 supports 6th Gen Intel® Core™ i5-6440EQ processor, HDMI 2.0, SATA 6Gb/s, dual Intel® GbE, USB 3.1 Gen 1 (5Gb/s), PCIe Mini, M.2, HD Audio and RoHS
KINO-DQM170-i3E-R10	Mini-ITX SBC with BGA 1440 supports 6th Gen Intel® Core™ i3-6102E processor, HDMI 2.0, SATA 6Gb/s, dual Intel® GbE, USB 3.1 Gen 1 (5Gb/s), PCIe Mini, M.2, HD Audio and RoHS
KINO-DQM170-CE-R10	Mini-ITX SBC with BGA 1440 supports 6th Gen Intel® Celeron® G3902E processor, HDMI 2.0, SATA 6Gb/s, dual Intel® GbE, USB 3.1 Gen 1 (5Gb/s), PCIe Mini, M.2, HD Audio and RoHS
32000-023800-RS	PS/2 KB/MS cable, 135mm/110mm, P=2.0
32001-008600-200-RS	Dual-port USB cable, 210mm, P=2.0
32001-008600-200-RS	Dual-port USB cable, 210mm, P=2.0
32005-000900-200-RS	RS-232/422/485 cable, 100mm, P=1.25



# KINO-AQ170

Mini-ITX SBC supports LGA 1151 Intel® Core™ i7/i5/i3, Pentium® or Celeron® CPU with Intel® Q170, HDMI 2.0/HDMI+DP/VGA, Dual Intel® GbE, SATA 6Gb/s, USB 3.1 Gen 1 (5Gb/s), PCIe Mini, HD Audio and RoHS

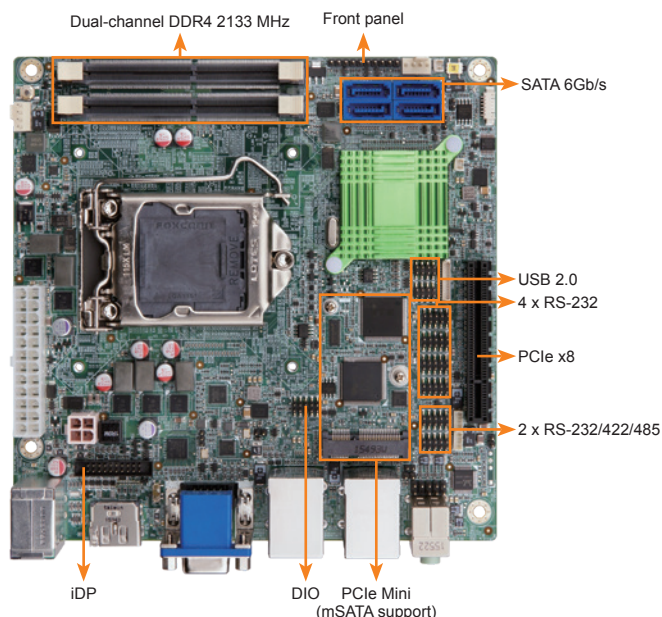

## Specifications

- ◆ CPU  
LGA 1151 socket supports Intel® 6th/7th generation Core™ i7/i5/i3, Pentium® or Celeron® processor
- ◆ Chipset  
Intel® Q170
- ◆ BIOS  
UEFI BIOS
- ◆ Memory  
Two 260-pin 2133 MHz dual-channel DDR4 SDRAM SO-DIMM support up to 64GB
- ◆ Graphics Engine  
Intel® HD Graphics Gen 9 support for DX11/12, OCL 2.x, OGL 4.3/4.4, ES 2.0 Decode/Encode for HEVC, VP8, VP9 2, VDENC
- ◆ Display Output  
Triple independent display  
1 x HDMI 2.0 (up to 4096x2160@60Hz)  
1 x HDMI/DP (up to 3840x2160@60Hz)  
1 x VGA (up to 1920x1200)  
1 x iDP interface for HDMI, LVDS, VGA, DVI, DP (up to 3840x2160@60Hz)
- ◆ Ethernet  
LAN1: Intel® I219LM with (Intel® AMT 11.0 support)  
LAN2: Intel® I211 PCIe controller with NCSI support
- ◆ External I/O Interface  
2 x USB 2.0  
4 x USB 3.1 Gen 1 (5Gb/s)
- ◆ Internal I/O Interface  
2 x RS-232/422/485 (2x5 pin, P=2.0)  
4 x RS-232 (2x5 pin, P=2.0)  
4 x SATA 6Gb/s (RAID 0/1/5/10 supported)  
4 x USB 2.0 (2x4 pin, P=2.0)
- ◆ Audio  
Realtek ALC662 HD Audio codec  
2 x Audio jacks (line-out, mic-in) on rear IO  
1 x Front audio (2x5-pin)
- ◆ Front Panel  
1 x Front panel (1x10 pin, power LED, HDD LED, power button, reset button)
- ◆ LAN LED: 2 x LAN LED (1x2 pin)
- ◆ SMBus: 1 x SMBus (1x4 pin)
- ◆ I<sup>2</sup>C: 1 x I<sup>2</sup>C (1x4 pin)
- ◆ Digital I/O: 8-bit digital I/O (2x5 pin)
- ◆ Expansion  
1 x PCIe x8 slot  
1 x Full-size PCIe Mini card slot (support mSATA)
- ◆ Chassis Intrusion Detection: 1 x Chassis intrusion connector (1x2 pin)
- ◆ Watchdog Timer  
Software programmable supports 1~255 sec. system reset by super I/O
- ◆ Power Supply  
ATX power supply
- ◆ Fan Connector  
1 x CPU smart fan (1x4 pin)  
1 x System smart fan (1x4 pin)
- ◆ Power Consumption  
3.3V@0.62A, 5V@3.3A, 12V@7.51A, 5VSB@0.23A  
(Intel® Core™ i7 6700K 4.0GHz CPU with 16 GB (two 8 GB) 2133 MHz DDR4 memory)
- ◆ Operating Temperature: -20°C ~ 60°C
- ◆ Operating Humidity: 5% ~ 95%, non-condensing
- ◆ Dimensions: 170mm x 170mm
- ◆ Weight: GW: 900g / NW: 450g
- ◆ CE/FCC compliant

## HDMI 2.0

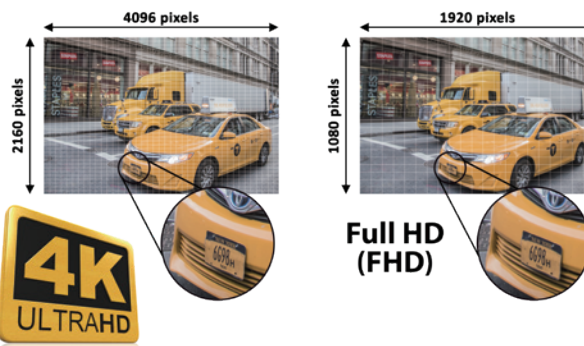

	HDMI 1.4	HDMI 2.0
Bandwidth	10.2Gbps	18Gbps
4K@30hz	Yes	Yes
4K@60hz	No	Yes
Up to 32 Audio Channels	No	Yes

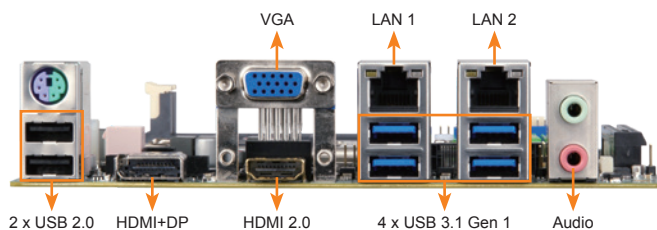

## Features

- LGA 1151 Intel® 6th/7th generation Core™ i7/i5/i3, Pentium® or Celeron® processor and DDR4 2133MHz memory support
- Support HDMI 2.0 (4096x2160@60Hz)
- Dual Intel® GbE support Intel® AMT 11.0
- Triple display via HDMI 2.0/HDMI/DP 1.2/VGA/iDP
- High speed I/O interface for USB 3.1 Gen 1 (5Gb/s), SATA 6Gb/s and mSATA support
- Support IEI jumpless

## Packing List

1 x KINO-AQ170 single board computer	2 x SATA cable
1 x I/O shielding	1 x QIG

## Ordering Information

Part No.	Description
KINO-AQ170-R10	Mini-ITX SBC supports 6th generation Intel® Core™ i7/i5/i3, Pentium® and Celeron® processor, HDMI 2.0/HDMI/DP/VGA, SATA 6Gb/s, dual Intel® GbE, USB 3.1 Gen 1 (5Gb/s), PCIe Mini, HD Audio and RoHS
32001-008600-200-RS	Dual-port USB cable, 210mm, P=2.0
32205-002700-200-RS	RS-232/422/485 cable, 230mm, P=2.0
CF-1156C-R20	LGA1155/LGA1156 cooler kit, 1U chassis compatible, 45W
CF-1156D-R20	LGA1155/LGA1156 cooler kit, 1U chassis compatible, 65W
CF-115XE-R10	High performance LGA1155/LGA1156 cooler kit, 95W
DP-DP-R10	DisplayPort to DP converter board (for IEI connector)
DP-DVI-R10	DisplayPort to DVI-D converter board (for IEI connector)
DP-HDMI-R10	DisplayPort to HDMI converter board (for IEI connector)
DP-LVDS-R10	DisplayPort to 24-bit dual-channel LVDS converter board (for IEI connector)
DP-VGA-R10	DisplayPort to VGA converter board (for IEI connector)





# KINO-DBT

Mini-ITX SBC supports 22nm Intel® Atom™ or Celeron® on-board SoC, VGA/DVI/iDP, dual Realtek PCIe GbE, USB 3.1 Gen 1 (5Gb/s), SATA, HD Audio, RoHS

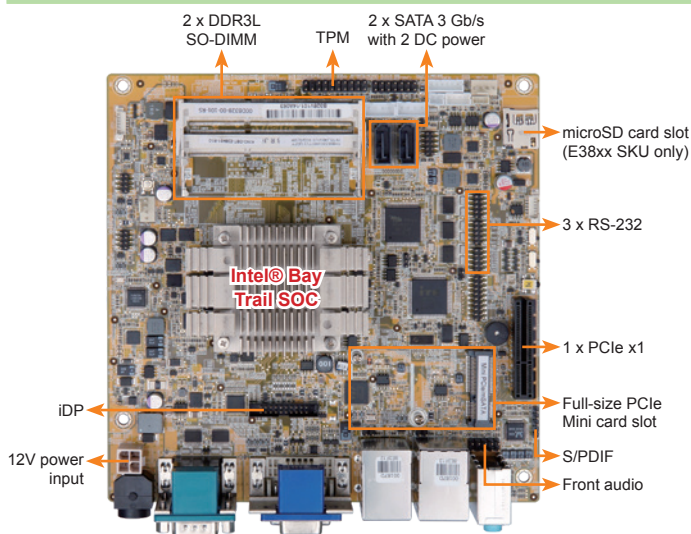

## Specifications

- ◆ SoC
  - Intel® Atom™ E3845 on-board SoC (1.91GHz, quad-core, 2MB cache, TDP=10W)
  - Intel® Atom™ E3827 on-board SoC (1.75GHz, dual-core, 1MB cache, TDP=8W)
  - Intel® Atom™ E3826 on-board SoC (1.46GHz, dual-core, 1MB cache, TDP=7W)
  - Intel® Atom™ E3825 on-board SoC (1.33GHz, dual-core, 1MB cache, TDP=6W)
  - Intel® Atom™ E3815 on-board SoC (1.46GHz, single-core, 512KB cache, TDP=5W)
  - Intel® Celeron® J1900 on-board SoC (2GHz, quad-core, 2MB cache, TDP=10W)
  - Intel® Celeron® N2930 on-board SoC (1.83GHz, quad-core, 2MB cache, TDP=7.5W)
  - Intel® Celeron® N2807 on-board SoC (1.58GHz, dual-core, 2MB cache, TDP=4.5W)
- ◆ BIOS
  - UEFI BIOS
- ◆ Memory
  - Two 204-pin 1066/1333 MHz dual-channel unbuffered DDR3L SDRAM SO-DIMM support up to 8 GB (J1900, N2930, E3845, E3827, E3826)
  - One 204-pin 1066/1333 MHz dual-channel unbuffered DDR3L SDRAM SO-DIMM supports up to 8 GB (E3825, E3815) or 4 GB (N2807)
- ◆ Graphics Engine
  - Intel® HD Graphics Gen 7 engine with 4 execution units, supporting DX11.1, OpenGL 4.2 and OpenCL 1.2
- ◆ Display Output
  - Dual independent display
  - 1 x VGA (up to 2560x1600@60 Hz)
  - 1 x DVI-D (up to 1920x1080@60 Hz)
  - 1 x iDP interface for HDMI, LVDS, VGA, DVI, DP (up to 2560x1600@60 Hz)
- ◆ Ethernet
  - LAN1: Realtek RTL8111E PCIe GbE controller
  - LAN2: Realtek RTL8111E PCIe GbE controller
- ◆ External I/O Interface
  - 2 x RS-232
  - 2 x USB 2.0
  - 2 x USB 3.1 Gen 1 (5Gb/s)
- ◆ Internal I/O Interface
  - 1 x KB/MS (1x6 pin)
  - 1 x mSATA (colay SATA2)
  - 2 x SATA 3Gb/s
  - 4 x USB 2.0 (2x4 pin, P=2.0)
- ◆ SMBus: 1 x SMBus (1x4 pin)
- ◆ TPM: 1 x TPM (2x10 pin)
- ◆ Audio
  - Realtek ALC662 HD Audio codec supports 5.1-channel
  - 3 x Audio jacks (line-out, line-in, mic-in) on rear IO
  - 1 x Front audio (2x5 pin)
  - 1 x S/PDIF (1x5 pin)
- ◆ Front Panel
  - 1 x Front panel (2x7 pin, power LED, HDD LED, speaker, power button, reset button)
- ◆ LAN LED: 2 x LAN LED (1x2 pin)
- ◆ Expansion
  - 1/2 x PCIe x4 slot (with PCIe x1 signal)
  - 1 x Full-size PCIe Mini card slot
- ◆ Digital I/O: 8-bit digital I/O (2x5 pin)
- ◆ Chassis Intrusion Detection: 1 x Chassis intrusion connector (1x2 pin)
- ◆ Fan Connector
  - 1 x CPU smart fan (1x4 pin)
  - 1 x System smart fan (1x4 pin)
- ◆ Power Supply
  - 12V DC input
  - 1 x External DC jack (4-pin DIN)
  - 1 x Internal power connector (2x2 pin)
- ◆ Power Consumption
  - 12V@1.64A (Intel® Celeron® J1900 CPU with 4 GB 1333 MHz DDR3L memory)
- ◆ Watchdog Timer: Software programmable supports 1~255 sec. system reset
- ◆ Operating Temperature: -20°C ~ 60°C
- ◆ Storage Temperature: -30°C ~ 70°C
- ◆ Operating Humidity: 5% ~ 95%, non-condensing
- ◆ Dimensions: 170mm x 170mm
- ◆ Weight: GW: 900g / NW: 400g
- ◆ CE/FCC compliant

## iDP (IEI Internal DisplayPort)

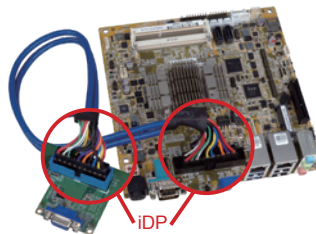

Model	Output	External Power
DP-VGA-R10	VGA	No
DP-HDMI-R10	HDMI	No
DP-DVI-R10	DVI	No
DP-LVDS-R10	LVDS	Yes
DP-DP-R10	DP	No

## Easy Installation on the Chassis

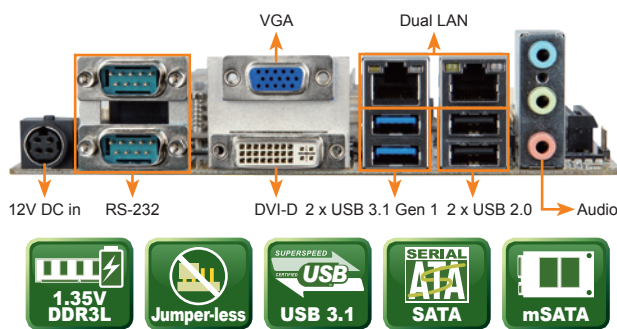

## Features

- Mini-ITX SBC with 22nm Intel® Atom™ on-board SoC
- 1.35V DDR3L 1066/1333 MHz SDRAM supporting up to 8 GB of memory
- Dual independent display support
- COM, USB 3.1 Gen 1 (5Gb/s), SATA 6Gb/s, PCIe Mini, mSATA and HD Audio support
- Support Intel® VT-x technology

## Packing List

1 x KINO-DBT single board computer	1 x SATA cable with power output cable
1 x IO shielding	1 x QIG

## Ordering Information

Part No.	Description
KINO-DBT-J19001-R10	Mini-ITX SBC supports Intel® Celeron® quad-core processor J1900 (10W), VGA/DVI/iDP, Dual PCIe GbE, USB 3.1 Gen 1 (5Gb/s), SATA, HD Audio and RoHS
KINO-DBT-N29301-R10	Mini-ITX SBC supports Intel® Celeron® quad-core processor N2930 (7.5W), VGA/DVI/iDP, Dual PCIe GbE, USB 3.1 Gen 1 (5Gb/s), SATA, HD Audio and RoHS
KINO-DBT-N28071-R10	Mini-ITX SBC supports Intel® Celeron® dual-core processor N2807 (4.5W), VGA/DVI/iDP, Dual PCIe GbE, USB 3.1 Gen 1 (5Gb/s), SATA, HD Audio and RoHS
KINO-DBT-E38XX1-R10**	Mini-ITX SBC supports Intel® Atom™ processor E38XX, VGA/DVI/iDP, Dual PCIe GbE, USB 3.1 Gen 1 (5Gb/s), SATA, HD Audio and RoHS
19800-000075-RS	PS/2 KB/MS cable with bracket, 220mm, P=2.0
32205-002700-200-RS	RS-232 cable, 200mm, P=2.0
32205-003800-300-RS	RS-422/485 cable, 200mm, P=2.0
DP-DP-R10	DisplayPort to DisplayPort converter board (for IEI iDP connector)
DP-DVI-R10	DisplayPort to DVI-D converter board (for IEI iDP connector)
DP-HDMI-R10	DisplayPort to HDMI converter board (for IEI iDP connector)
DP-LVDS-R10	DisplayPort to 24-bit dual-channel LVDS converter board (for IEI iDP connector)
DP-VGA-R10	DisplayPort to VGA converter board (for IEI iDP connector)
TPM-IN01-R20	20-pin Infineon TPM module, software management tool, firmware v3.17

\*\*By order production, MOQ: 100







## eKINO-BT

Mini-ITX SBC supports AUPS sub-system, 22nm Intel® Atom™/Celeron® on-board SoC, wide-range 9V ~ 26V DC input, VGA/dual LVDS, SATA, dual GbE, USB 3.1 Gen 1 (5Gb/s), audio, CFast and RoHS

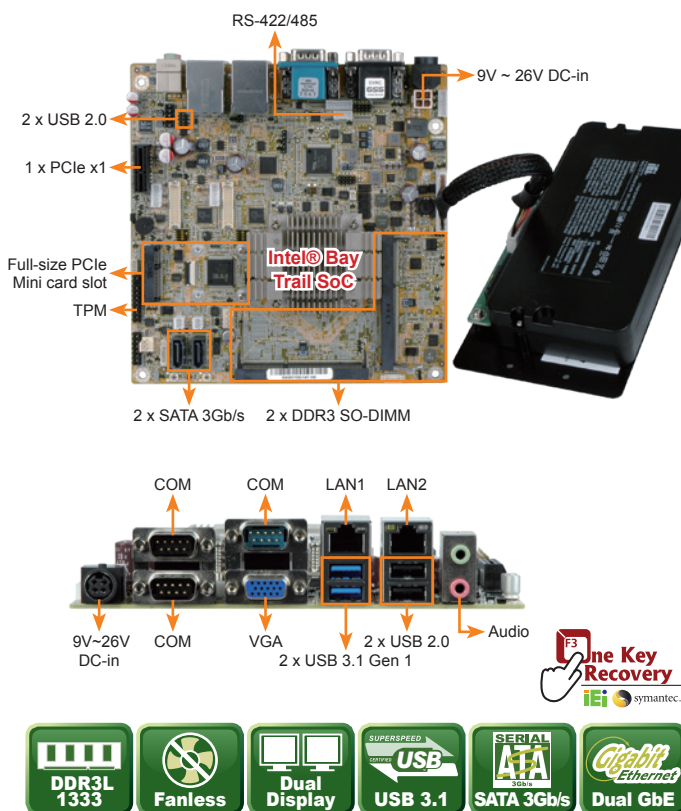

## Specifications

- ◆ CPU
  - Intel® Atom™ E3845 on-board SoC (1.91GHz, quad-core, 2MB cache, TDP=10W)
  - Intel® Atom™ E3827 on-board SoC (1.75GHz, dual-core, 1MB cache, TDP=8W)
  - Intel® Atom™ E3826 on-board SoC (1.46GHz, dual-core, 1MB cache, TDP=7W)
  - Intel® Atom™ E3825 on-board SoC (1.33GHz, dual-core, 1MB cache, TDP=6W)
  - Intel® Atom™ E3815 on-board SoC (1.46GHz, single-core, 512KB cache, TDP=5W)
  - Intel® Celeron® J1900 on-board SoC (2GHz, quad-core, 2MB cache, TDP=10W)
  - Intel® Celeron® N2930 on-board SoC (1.83GHz, quad-core, 2MB cache, TDP=7.5W)
  - Intel® Celeron® N2807 on-board SoC (1.58GHz, dual-core, 2MB cache, TDP=4.3W)
- ◆ BIOS
  - UEFI BIOS
- ◆ Memory
  - Two 204-pin 1066/1333 MHz dual-channel unbuffered DDR3L SDRAM SO-DIMM support up to 8 GB (J1900, N2930, E3845, E3827, E3826)
  - One 204-pin 1066/1333 MHz dual-channel unbuffered DDR3L SDRAM SO-DIMM supports up to 8 GB (E3825, E3815) or 4 GB (N2807)
- ◆ Graphics Engine
  - Intel® HD Graphics Gen 7 Engines with 4 execution units, supporting DX11.1, OpenGL 4.2 and OpenCL1.2
- ◆ Display Output
  - 1 x VGA (up to 2560x1600@60Hz)
  - 2 x 18/24-bit dual-channel LVDS (up to 1920x1200@60Hz)
- ◆ External I/O Interface
  - 2 x USB 2.0
  - 2 x USB 3.1 Gen 1 (5Gb/s)
  - 3 x RS-232
- ◆ Internal I/O Interface
  - 1 x CFast slot
  - 1 x KB/MS (1x6 pin)
  - 1 x MicroSD card slot
  - 1 x RS-232 (2x5 pin, P=2.0)
  - 1 x RS-422/485 (1x4 pin, P=2.0)
  - 2 x SATA 3Gb/s with 5V SATA power connector
  - 2 x USB 2.0 (2x4 pin, P=2.0)
- ◆ Ethernet
  - Dual LAN: Realtek RTL8111E PCIe controller
- ◆ TPM
  - 1 x TPM (2x10 pin)
- ◆ SMBus
  - 1 x SMBus (1x4 pin)
- ◆ Front Panel
  - 1 x Front panel (2x7 pin, power LED, HDD LED, speaker, power button, reset button)
- ◆ LAN LED
  - 2 x LAN LED (1x2 pin)
- ◆ Digital I/O
  - 8-bit digital I/O (2x5 pin)
- ◆ Expansion
  - 1 x PCIe x1 slot
  - 1 x Full-size PCIe Mini card slot
- ◆ Audio
  - Realtek ALC662 HD Audio codec
  - 2 x Audio jacks (line-out, mic-in) on rear I/O
  - 1 x Front audio (2x5 pin)
- ◆ Watchdog Timer
  - Software programmable supports 1~255 sec. system reset
- ◆ Power Supply
  - 1 x External DC power jack (4-pin DIN)
  - 1 x Internal power connector (2x2 pin)
  - Input voltage range: 9V ~ 26V
  - Recommended operating input voltage range: 12V~24V
- ◆ Fan Connector
  - 1 x CPU smart fan (1x4 pin)
  - 1 x System fan (1x3 pin)
- ◆ Power Consumption
  - +12V@1.55A (Intel® Celeron® J1900 CPU with two 4 GB 1333 MHz DDR3L memory)
- ◆ Operating Temperature
  - 0°C ~ 40°C with AUPS sub-system
  - 20°C ~ 60°C without AUPS sub-system
- ◆ Storage Temperature
  - 10°C ~ 50°C with AUPS sub-system
  - 30°C ~ 70°C without AUPS sub-system
- ◆ Operating Humidity
  - 5% ~ 95%, non-condensing
- ◆ Weight
  - GW: 1100g / NW: 400g
- ◆ CE/FCC compliant

## AUPS Battery Kit

• BATKIT-2S2P3800-R10

• BATKIT-4S2P3800-R10



P/N: BAT-LI-2S2P3800  
2S2P 7.4V 3800mAh

P/N: BAT-LI-4S2P3800  
4S2P 14.8V 3800mAh

## Battery Specifications

Battery Model	BAT-LI-2S2P3800	BAT-LI-4S2P3800
Battery type	Li-Ion 2S2P 7.4V	Li-Ion 4S2P 14.8V
Battery capacity	7.4V 3800mAh	14.8V, 3800mAh
Maximum charge voltage	8.4V	16.8V
The end of discharging voltage	5.6V	11.2V
Battery charge time (Power off)	2.5hrs	5hrs
Battery charge time (Power on)	6.5hrs	13hrs
Operating temp.	0°C ~ 40°C	0°C ~ 40°C
Storage temp.	-20°C ~ 60°C	-20°C ~ 60°C
Cycle life	300 charge/discharge cycles	
Backup	60W/10Min	100W/10Min
Safety class	CE	

## Features

- Mini ITX supports Intel® 22nm Atom™ or Celeron® on-board SoC
- Wide-range 9V ~ 26V DC input design
- Supports dual independent display with dual LVDS and VGA
- Equipped with AUPS sub-system, acts as a simple UPS system
- Supports four USB 2.0, two USB 3.1 Gen 1 (5Gb/s), two SATA and four COM
- IEI jumper-less function

## Packing List

- 1 x eKINO-BT single board computer
- 2 x SATA with 5V output cable kit
- 1 x I/O shielding
- 1 x QIG

## Ordering Information

Part No.	Description
EKINO-BT-J19001-R10	Mini-ITX SBC supports AUPS sub-system, Intel® Celeron® quad-core processor J1900 (10W), wide-range 9V ~ 26V DC input, VGA/dual LVDS, SATA, USB 3.1 Gen 1 (5Gb/s), dual GbE, audio, CFAST and RoHS
EKINO-BT-N29301-R10	Mini-ITX SBC supports AUPS sub-system, Intel® Celeron® quad-core processor N2930 (7.5W), wide-range 9V ~ 26V DC input, VGA/dual LVDS, SATA, USB 3.1 Gen 1 (5Gb/s), dual GbE, audio, CFAST and RoHS
EKINO-BT-N28071-R10	Mini-ITX SBC supports AUPS sub-system, Intel® Celeron® dual-core processor N2807 (4.3W), wide-range 9V ~ 26V DC input, VGA/dual LVDS, SATA, USB 3.1 Gen 1 (5Gb/s), dual GbE, audio, CFAST and RoHS
EKINO-BT-E38XX1-R10**	Mini-ITX SBC supports AUPS sub-system, Intel® Atom™ E38XX on-board SoC, wide-range 9V ~ 26V DC input, VGA/dual LVDS, SATA, dual GbE, USB 3.1 Gen 1 (5Gb/s), audio, CFAST and RoHS (by request MOQ: 100pcs/lot)
BATKIT-2S2P3800-R10	2S2P 7.4V 3800mAh AUPS battery kit
BAT-LI-2S2P3800	2S2P 7.4V 3800mAh smart battery
BATKIT-4S2P3800-R10	4S2P 14.8V 3800mAh AUPS battery kit
BAT-LI-4S2P3800	4S2P 14.8V 3800mAh smart battery
19800-000075-RS	PS/2 KB/MS cable with bracket, 220mm, P=2.0
32001-008600-200-RS	Dual-port USB 2.0 cable, 210mm, P=2.0
32205-003800-300-RS	RS-422/485 cable, 200mm, P=2.0
63040-010060-110-RS	60W/12V power adaptor, 90VAC~260VAC, 4-pin DIN
63040-010120-210-RS	120W/19V power adaptor, 90VAC~264VAC, 4-pin DIN
CB-USB02A-RS	Dual-port USB 2.0 cable with bracket, 300mm, P=2.0

\*\*By order production, MOQ: 100

# KINO-DQM871-i1

Mini-ITX SBC supports 4th generation 22nm Intel® mobile processors, HDMI/ VGA/LVDS/DP, dual Intel® PCIe GbE, USB 3.1 Gen 1 (5Gb/s), SATA 6Gb/s, iRIS-1010, audio and RoHS

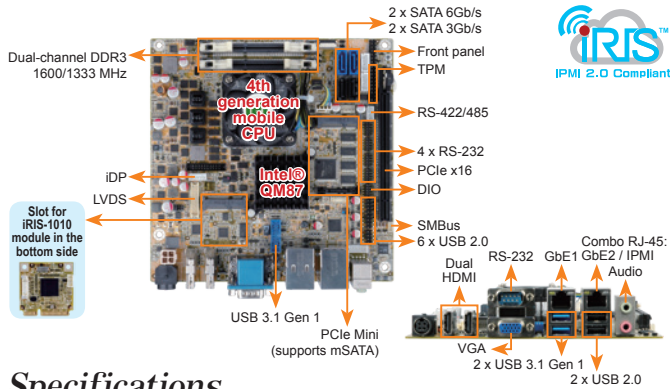

## Specifications

- ◆ CPU: Intel® mobile Core™ i7-4700EQ on-board processor with Intel® AMT 9.0 support (2.4GHz, quad-core, 6MB cache, TDP=47W)  
Intel® mobile Core™ i5-4402E on-board processor with Intel® AMT 9.0 support (1.6GHz, dual-core, 3MB cache, TDP=25W)  
Intel® mobile Core™ i5-4400E on-board processor with Intel® AMT 9.0 support (2.7GHz, dual-core, 3MB cache, TDP=37W) (by request)
- ◆ Chipset: Intel® QM87
- ◆ Memory: Two 204-pin 1600/1333 MHz dual-channel DDR3 SDRAM unbuffered DIMMs support up to 16 GB
- ◆ BIOS: UEFI BIOS
- ◆ Ethernet: LAN1: Intel® I217LM with Intel® AMT 9.0 support  
LAN2: Intel® I210-AT PCIe controller
- ◆ Graphics Engine: Intel® HD Graphics Gen 7.5 supports DX11.1 and OpenCL 1.2, OpenGL 3.2  
Full MPEG2, VC1, AVC Decode
- ◆ Audio: Realtek ALC662 HD codec supports 5.1-channel  
2 x Audio jacks (line-out, mic-in) on rear IO
- ◆ iRIS Remote Management Module: 1 x iRIS-1010 slot
- ◆ LAN LED: 2 x LAN LED (1x2 pin)
- ◆ Display Output: 1 x VGA (up to 1920x1200@60Hz)  
1 x 18/24-bit dual-channel LVDS (up to 1920x1200@60Hz)  
2 x HDMI (up to 2500x1600@60Hz)  
1 x iDP interface for HDMI, LVDS, VGA, DVI, DP (up to 3840x2160@60Hz)
- ◆ External I/O Interface: 1 x RS-232 2 x USB 2.0  
2 x USB 3.1 Gen 1 (5Gb/s)
- ◆ Internal I/O Interface: 1 x KB/MS (1x6 pin)  
1 x RS-422/485 (1x4 pin, P=2.0)  
2 x SATA 3Gb/s  
2 x SATA 6Gb/s (RAID 0/1/5/10 supported)  
2 x USB 3.1 Gen 1 (5Gb/s) (2x10 pin, P=2.0)  
4 x RS-232 (2x5 pin, P=2.0)  
6 x USB 2.0 (2x4 pin, P=2.54)
- ◆ Front Panel: 1 x Front panel (2x7 pin, power LED, HDD LED, speaker, power button, reset button)
- ◆ SMBus: 1 x SMBus (1x4 pin)
- ◆ TPM: 1 x TPM (2x10 pin)
- ◆ Expansion: 1 x PCIe x16 slot  
1 x Full-size PCIe Mini card slot (support mSATA)
- ◆ Watchdog Timer: Software programmable, support 1~255 sec. system reset
- ◆ Digital I/O: 8-bit digital I/O (2x5 pin)
- ◆ Fan Connector: 1 x CPU smart fan (1x4 pin)  
1 x System smart fan (1x4 pin)
- ◆ Power Supply: 12V DC input  
1 x Internal power connector (2x2 pin)  
1 x External DC jack (4-pin DIN)  
Support AT/ATX mode
- ◆ Power Consumption: 12V@6.03A (Intel® Core™ i7-4770EQ, 2.4GHz CPU with 8 GB (two 4 GB) 1333 MHz DDR3 memory)  
◆ Operating Temperature: -20°C ~ 60°C  
◆ Operating Humidity: 5% ~ 95%, non-condensing  
◆ Dimensions: 170mm x 170mm  
◆ Weight: GW: 900g / NW: 450g  
◆ CE/FCC compliant

## Packing List

1 x KINO-DQM871-i1 motherboard	2 x SATA with power output cable
1 x CPU cooler	1 x Mini jumper pack
1 x I/O shielding	1 x QIG

## Ordering Information

Part No.	Description
KINO-DQM871-i1-i7-R10	Mini-ITX SBC supports Intel® 22nm mobile Core™ i7-4700EQ on-board processor, HDMI/VGA/LVDS/DP, AMT 9.0, dual Intel® PCIe GbE, USB 3.1 Gen 1 (5Gb/s), SATA 6Gb/s, iRIS-1010, audio and RoHS
KINO-DQM871-i1-i5E-R10	Mini-ITX SBC supports Intel® 22nm mobile Core™ i5-4402E on-board processor, HDMI / VGA / LVDS / DP, dual Intel® PCIe GbE, AMT 9.0, USB 3.1 Gen 1 (5Gb/s), SATA 6Gb/s, iRIS-1010, audio and RoHS
iRIS-1010-R10	IPMI 2.0 adapter card with AST1010 BMC chip (W/O KVM over IP function) for PCIe Mini socket interface
19800-000300-100-RS	RS-232 cable with bracket, 300mm, P=2.0
19800-003100-100-RS	Dual port USB 2.0 cable with bracket, 300mm, P=2.54
19800-010500-200-RS	USB 3.1 Gen 1 (5Gb/s) cable with bracket, 450mm
32000-023800-RS	PS/2 KB/MS cable, 135mm/110mm, P=2.0
32205-003800-200-RS	RS-422/485 cable, 200mm, P=2.0
DP-DP-R10	DisplayPort converter board (for IEI iDP connector)
DP-DVI-R10	DisplayPort to DVI-D converter board (for IEI iDP connector)
DP-HDMI-R10	DisplayPort to HDMI converter board (for IEI iDP connector)
DP-LVDS-R10	DisplayPort to 24-bit dual-channel LVDS converter board (for IEI iDP connector)
DP-VGA-R10	DisplayPort to VGA converter board (for IEI iDP connector)
TPM-IN01-R20	20-pin Infineon TPM module, software management tool, firmware v3.17

# KINO-QM770

Mini-ITX SBC with Socket G2 for Intel® 22nm mobile CPU, DVI-I, dual HDMI, LVDS, dual PCIe GbE, USB 3.1 Gen 1 (5Gb/s), PCIe Mini, SATA 6Gb/s and audio

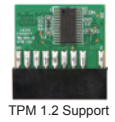
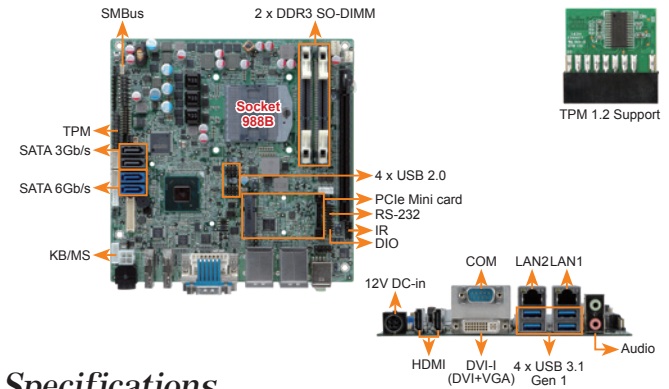

## Specifications

- ◆ CPU: Socket G2 for 3rd generation Intel® 22nm mobile processor
- ◆ Chipset: Intel® QM77
- ◆ Memory: Two 240-pin 1600/1333 MHz dual-channel DDR3 SDRAM unbuffered DIMMs support up to 16 GB
- ◆ BIOS: UEFI BIOS
- ◆ Ethernet: LAN1: Intel® 82579 PHY with Intel® AMT 8.0 support  
LAN2: Intel® 82583V PCIe controller
- ◆ Graphics Engine: Supports DX11 and OpenGL 3.1  
Full MPEG2, VC1, AVC Decode
- ◆ Display Output: 1 x DVI-I (up to 1920x1200@60Hz)  
1 x 18/24-bit dual-channel LVDS (up to 1920x1200@60Hz)  
2 x HDMI (up to 1920x1200@60Hz)
- ◆ Audio: Realtek ALC892 HD codec  
2 x Audio jacks (line-out, mic-in) on rear IO  
1 x Front Audio (2x5 pin)
- ◆ SMBus: 1 x SMBus (1x4 pin)
- ◆ TPM: 1 x TPM (2x10 pin)
- ◆ Expansion: 1 x PCIe x16 slot 1 x PCIe Mini card slot
- ◆ Digital I/O: 8-bit digital I/O (2x5 pin)
- ◆ External I/O Interface: 1 x RS-232 4 x USB 3.1 Gen 1 (5Gb/s)
- ◆ Internal I/O Interface: 1 x KB/MS (1x6 pin)  
2 x SATA 3Gb/s  
1 x RS-232 (2x5 pin, P=2.0)  
2 x SATA 6Gb/s (RAID 0/1/5/10 supported)  
1 x RS-422/485 (1x4 pin, P=2.0)  
2 x USB 2.0 (2x4 pin, P=2.54)
- ◆ Watchdog Timer: Software programmable supports 1~255 sec. system reset
- ◆ Infrared Interface: 1 x Infrared interface (1x5 pin)
- ◆ Fan Connector: 1 x CPU smart fan (1x4 pin)  
1 x System fan (1x3 pin)
- ◆ Power Supply: 12V DC input  
1 x Internal power connector (2x2 pin)  
1 x External DC jack (4-pin DIN)  
Support AT/ATX mode
- ◆ Power Consumption: 12V@6.08A (2.3GHz Intel® Core™ i7-3610QE with two 1333 MHz 4 GB DDR3 memory running 3DMark06 burn in)  
◆ Operating Temperature: -10°C ~ 60°C  
◆ Storage Temperature: -20°C ~ 70°C  
◆ Operating Humidity: 5% ~ 95%, non-condensing  
◆ Dimensions: 170 mm x 170 mm  
◆ Weight: GW: 900g / NW: 450g  
◆ CE/FCC compliant

## Dimensions (Unit: mm)

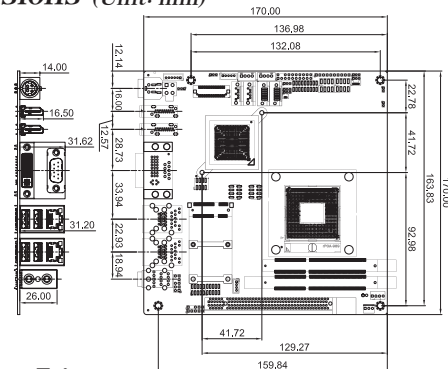

## Packing List

1 x KINO-QM770 single board computer	2 x SATA with power output cable
1 x I/O shielding	1 x Mini jumper pack
1 x RS-232 cable with bracket	1 x QIG

## Ordering Information

Part No.	Description
KINO-QM770-R10	Mini-ITX SBC with Socket G2 for Intel® 22nm mobile CPU, DVI-I/dual HDMI/LVDS, dual PCIe GbE, USB 3.1 Gen 1 (5Gb/s), PCIe Mini, SATA 6Gb/s and Audio
19800-003100-100-RS	Dual port USB 2.0 cable with bracket, 300mm, P=2.54
32000-023800-RS	PS/2 KB/MS cable, 135mm/110mm, P=2.0
32205-003800-300-RS	RS-422/485 cable, 200mm, P=2.0
33200-000031-RS	DVI-I to VGA adapter connector
CF-989A-RS-R12	CPU cooler for mobile socket-G (PGA988) up to 55W processor, copper, 60 x 60 x 27.6mm, RoHS
SACF-KIT01-R10	SATA to CF converter board
TPM-IN01-R20	20-pin Infineon TPM module, software management tool, firmware v3.17



# KINO-DH610

Mini-ITX SBC supports LGA1155 Intel® Core™ i7/i5/i3/Pentium®/Celeron® CPU, DDR3, VGA/DVI-D/HDMI, dual PCIe GbE, USB 2.0, SATA 3Gb/s, HD Audio and RoHS

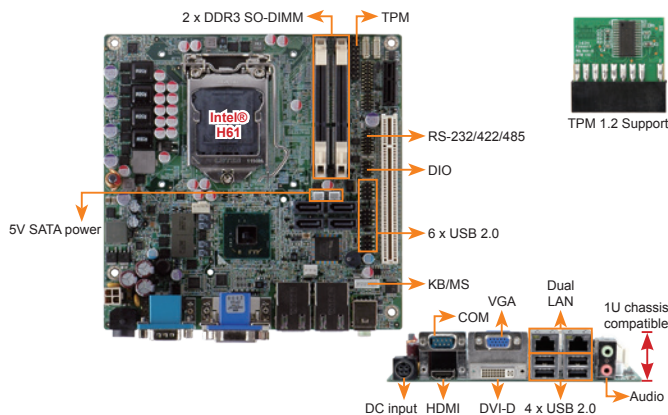

## Specifications

- ◆ CPU: LGA1155 socket supports Intel® Core™ i7/i5/i3/Pentium®/Celeron® dual-core processor (TDP 65W max.)
- ◆ Chipset: Intel® H61
- ◆ Memory: Two 204-pin 1066/1333 MHz dual-channel unbuffered DDR3L SDRAM SO-DIMM support up to 16 GB
- ◆ BIOS: UEFI BIOS
- ◆ Ethernet: LAN1: Realtek RTL8111E PCIe GbE controller with ASF 2.0 support; LAN2: Realtek RTL8111E PCIe GbE controller
- ◆ Graphics Engine: Supports DX10.1 and OpenGL 3.0; Full MPEG2, VC1, AVC Decode
- ◆ Display Output: Dual display supported; 1 x VGA (up to 2048x1536@75Hz); 1 x HDMI (up to 1920x1200@60Hz); 1 x DVI-D (up to 1920x1200@60Hz)
- ◆ External I/O Interface: 1 x RS-232; 4 x USB 2.0
- ◆ Internal I/O Interface: 1 x KB/MS (1x6 pin); 1 x RS-232/422/485 (2x7 pin, P=2.0); 2 x SATA power connector; 4 x SATA 3Gb/s; 6 x USB 2.0 (2x4 pin, P=2.54)
- ◆ TPM: 1 x TPM (2x10 pin)
- ◆ Audio: Realtek ALC662 HD codec; 2 x Audio jacks (line-out, mic-in) on rear I/O
- ◆ Expansions: 1 x PCI slot; 1 x PCIe x1 slot
- ◆ Watchdog Timer: Software programmable supports 1~255 sec. system reset
- ◆ Fan Connector: 1 x CPU smart fan (1x4 pin); 1 x System fan (1x3 pin)
- ◆ Power Supply: Maximum input voltage range: 9V ~ 28V; Recommended operating input voltage range: 12V ~ 24V; 1 x External DC jack (4-pin DIN); 1 x Internal power connector (2x2 pin)
- ◆ Power Consumption: 12V@5.07A (2.2GHz Intel® G620T with two 1066 MHz 2 GB DDR3 memory running 3DMark06 burn in); 12V@8.85A (2.8GHz Intel® Core™ i7-2600S with two 1066 MHz 2 GB DDR3 memory running 3DMark06 burn in)
- ◆ Operating Temperature: -10°C ~ 60°C
- ◆ Storage Temperature: -20°C ~ 70°C
- ◆ Operating Humidity: 5% ~ 95%, non-condensing
- ◆ Dimensions: 170 mm x 170 mm
- ◆ Weight: GW: 1100g / NW: 700g
- ◆ CE/FCC compliant

## Packing List

1 x KINO-DH610 single board computer	
1 x I/O shielding	1 x Mini jumper pack
2 x SATA with 5V power cable	1 x QIG

## Ordering Information

Part No.	Description
KINO-DH610-R10	Mini-ITX SBC supports LGA1155 Intel® Core™ i5/i3/Pentium®/Celeron® CPU, DDR3, VGA/DVI-D/HDMI, dual PCIe GbE, USB 2.0, SATA 3Gb/s, HD Audio and RoHS
CPU-DT-i5-2500T	Intel® Core™ i5-2500T processor, LGA1155, quad core 2.3GHz, 6M cache, 45W, compatible with CF-1156C-R20 CPU cooler
CPU-DT-i5-2390T	Intel® Core™ i5-2390T processor, LGA1155, dual core 2.7GHz, 3M cache, 35W, AMT, compatible with CF-1156C-R20 CPU cooler
CPU-DT-i3-2120T	Intel® Core™ i3-2120T processor, LGA1155, dual core 2.6GHz, 3M cache, 35W, compatible with CF-1156C-R20 CPU cooler
CPU-DT-C-G440	Intel® Celeron® G440 processor, LGA1155, single core 1.6GHz, 1M cache, 35W, compatible with CF-1156C-R20 CPU cooler
CPU-DT-P-G630T	Intel® Pentium® G630T processor, LGA1155, dual core 2.3GHz, 3M cache, 35W, compatible with CF-1156C-R20 CPU cooler
19800-003100-300-RS	Dual port USB cable with bracket, 300mm, P=2.54
19800-004300-100-RS	RS-232 & RS-422/485 cable with bracket, 14-pin to two DB-9, 250mm, P=2.0
32000-023800-RS	PS/2 KB/MS cable, 135mm, P=2.0
63040-010060-110-RS	12V 60W power adaptor with 4-pin DIN lock, 90 ~ 264VAC input, ErP
CF-115XA-R10	High-performance LGA1155/LGA1156 cooler kit, 1U chassis compatible, 73W
CF-1156C-R20	LGA1155/LGA1156 cooler kit, 1U chassis compatible, 45W
CF-1156D-R20	LGA1155/LGA1156 cooler kit, 1U chassis compatible, 65W
CF-115XE-R10	High-performance LGA1155/LGA1156 cooler kit, 95W
SACF-KIT01-R10	SATA to CF converter board
TPM-IN01-R20	20-pin Infineon TPM module, software management tool, firmware v3.17

# KINO-AH612

Mini-ITX SBC supports LGA1155 Intel® Core™ i7/i5/i3/Pentium®/Celeron® CPU with H61, DDR3, VGA/DVI-D, six COMs, dual PCIe GbE, SATA 3Gb/s, HD Audio and RoHS

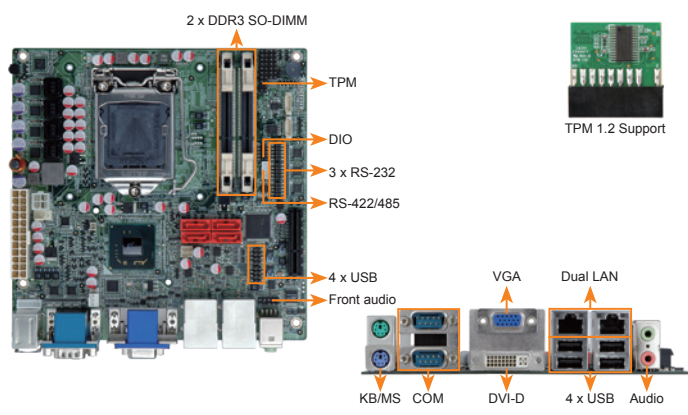

## Features

- ◆ LGA1155 Intel® Core™ i7/i5/i3/Pentium®/Celeron® processor supported
- ◆ Dual-channel 1333/1066 MHz DDR3 supports up to 16 GB
- ◆ Supports dual independent display by VGA and DVI-D
- ◆ Supports six COM ports, four SATA 3Gb/s ports and one PCIe x4 slot for IO expansion card
- ◆ IEI One Key Recovery solution allows you to create rapid OS backup and recovery

## Specifications

- ◆ CPU: LGA1155 socket supports Intel® Core™ i7/i5/i3/Pentium®/Celeron® processor
- ◆ Chipset: Intel® H61
- ◆ Memory: Two 204-pin 1066/1333 MHz dual-channel unbuffered DDR3L SDRAM SO-DIMM support up to 16 GB
- ◆ BIOS: UEFI BIOS
- ◆ Ethernet: LAN1: Realtek RTL8111E PCIe GbE controller with ASF 2.0 support
- ◆ Graphics Engine: Supports DX10.1 and OpenGL 3.0; Full MPEG-2, VC1, AVC Decode
- ◆ Display Output: Dual display supported; 1 x VGA (up to 2048x1536@75Hz); 1 x DVI-D (up to 1920x1200@60Hz)
- ◆ Audio: Realtek ALC662 HD codec; 2 x Audio jacks (line-out, mic-in) on rear I/O; 1 x Front Audio (2x5 pin)
- ◆ External I/O Interface: 1 x KB/MS; 2 x RS-232; 4 x USB 2.0
- ◆ Internal I/O Interface: 1 x KB/MS (1x6 pin); 4 x SATA 3Gb/s; 1 x RS-422/485 (1x4 pin, P=2.0); 3 x RS-232 (2x5 pin, P=2.0); 4 x USB 2.0 (2x4 pin, P=2.54)
- ◆ TPM: 1 x TPM (2x10 pin)
- ◆ Expansion: 1 x PCIe x4 slot
- ◆ Watchdog Timer: Software programmable supports 1~255 sec. system reset
- ◆ Digital I/O: 8-bit digital I/O (2x5 pin)
- ◆ Fan Connector: 1 x CPU smart fan (1x4 pin); 1 x System fan (1x3 pin)
- ◆ Power Supply: ATX power supply; 5V@3.9A, 12V@0.36A, Vcore\_12V@8.28A, 3.3V@1.24A, 5VSB@0.18A (3.4GHz Intel® Core™ i7-2600 with two 1333 MHz 2 GB DDR3 memory)
- ◆ Operating Temperature: -10°C ~ 60°C
- ◆ Storage Temperature: -20°C ~ 70°C
- ◆ Operating Humidity: 5% ~ 95%, non-condensing
- ◆ Dimensions: 170 mm x 170 mm
- ◆ Weight: GW: 1100g / NW: 700g
- ◆ CE/FCC compliant

## Packing List

1 x KINO-AH612 single board computer	2 x SATA cable
1 x Dual RS-232 cable	1 x Mini jumper pack
1 x I/O shielding	1 x QIG

## Ordering Information

Part No.	Description
KINO-AH612-R10	Mini-ITX SBC supports LGA1155 Intel® Core™ i7/i5/i3/Pentium®/Celeron® CPU with H61, DDR3, VGA/DVI-D, 6 COM, dual PCIe GbE, SATA 3Gb/s, HD Audio and RoHS
CPU-DT-i5-2500T	Intel® Core™ i5-2500T processor, LGA1155, quad core 2.3GHz, 6M cache, 45W, compatible with CF-1156C-R20 CPU cooler
CPU-DT-i5-2390T	Intel® Core™ i5-2390T processor, LGA1155, dual core 2.7GHz, 3M cache, 35W, AMT, compatible with CF-1156C-R20 CPU cooler
CPU-DT-i3-2120T	Intel® Core™ i3-2120T processor, LGA1155, dual core 2.6GHz, 3M cache, 35W, compatible with CF-1156C-R20 CPU cooler
CPU-DT-C-G440	Intel® Celeron® G440 processor, LGA1155, single core 1.6GHz, 1M cache, 35W, compatible with CF-1156C-R20 CPU cooler
CPU-DT-P-G630T	Intel® Pentium® G630T processor, LGA1155, dual core 2.3GHz, 3M cache, 35W, compatible with CF-1156C-R20 CPU cooler
19800-003100-100-RS	Dual port USB 2.0 cable with bracket, 300mm, P=2.54
32102-000100-200-RS	SATA power cable, MOLEX 5264-4P to SATA15P
CF-115XA-R10	High-performance LGA1155/LGA1156 cooler kit, 1U chassis compatible, 73W
CF-1156C-R20	LGA1155/LGA1156 cooler kit, 1U chassis compatible, 45W
CF-1156D-R20	LGA1155/LGA1156 cooler kit, 1U chassis compatible, 65W
CF-115XE-R10	High-performance LGA1155/LGA1156 cooler kit, 95W
SACF-KIT01-R10	SATA to CF converter board
TPM-IN01-R20	20-pin Infineon TPM module, software management tool, firmware v3.17



Mini-ITX Dimensions (Unit: mm)

**1KINO-AL**

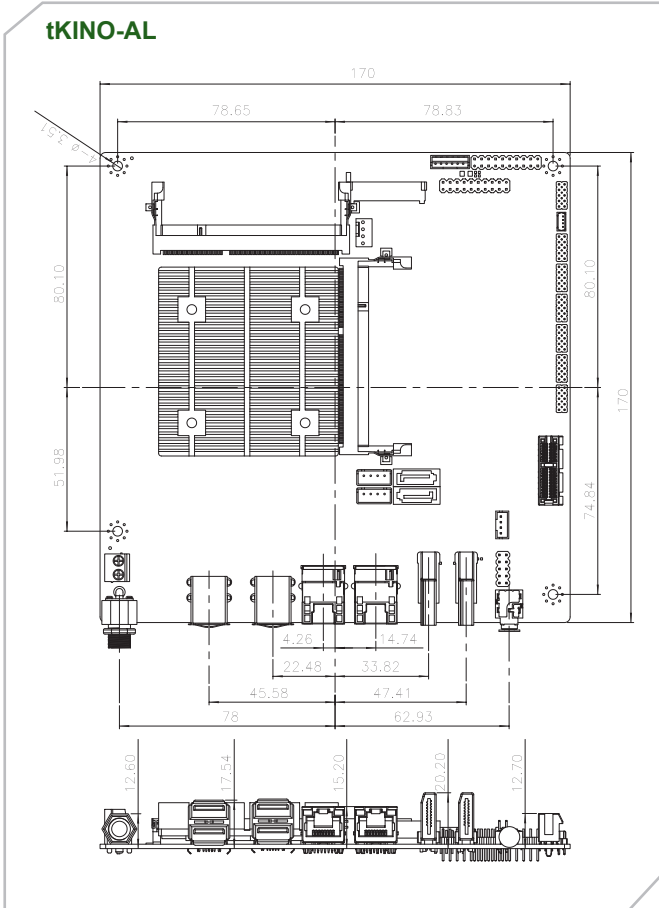

**1KINO-ULT3**

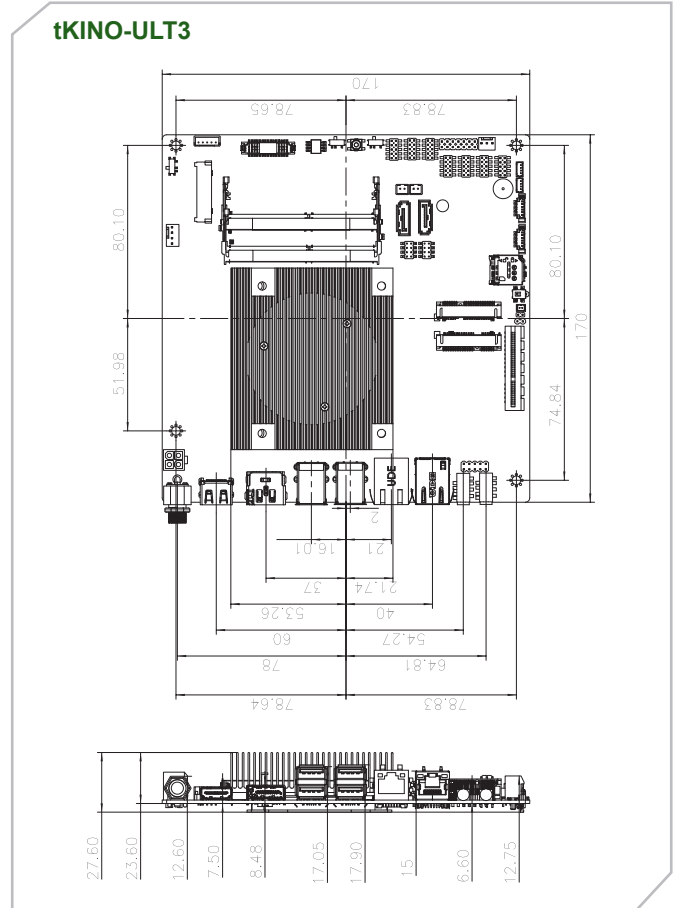

**gKINO-DMF**

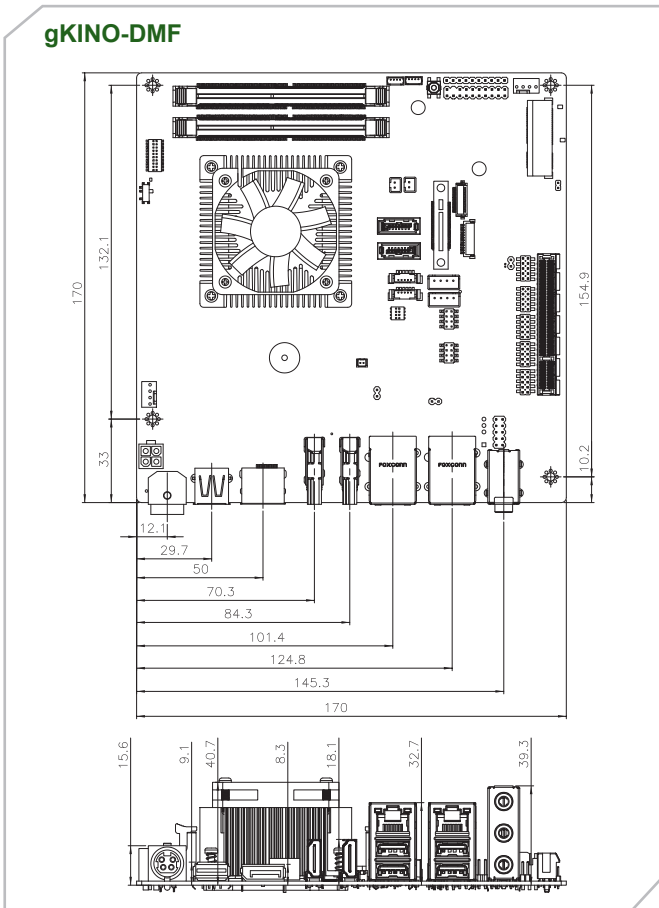

**KINO-DCM236**

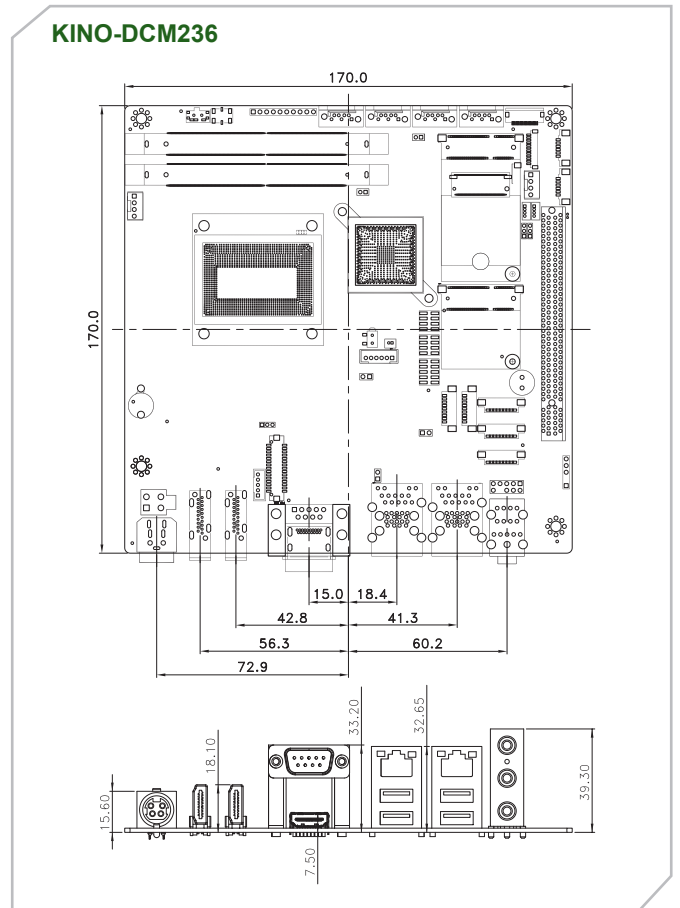

Mini-ITX Dimensions (Unit: mm)

KINO-DQM170

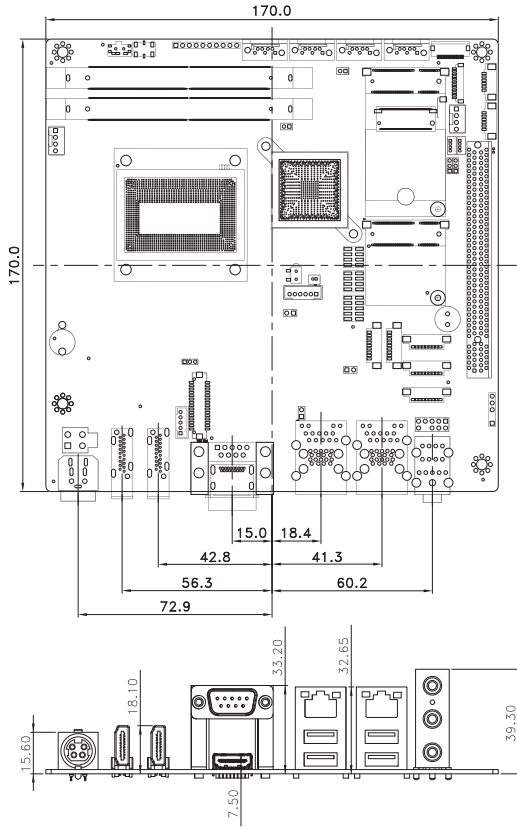

1KINO-BW

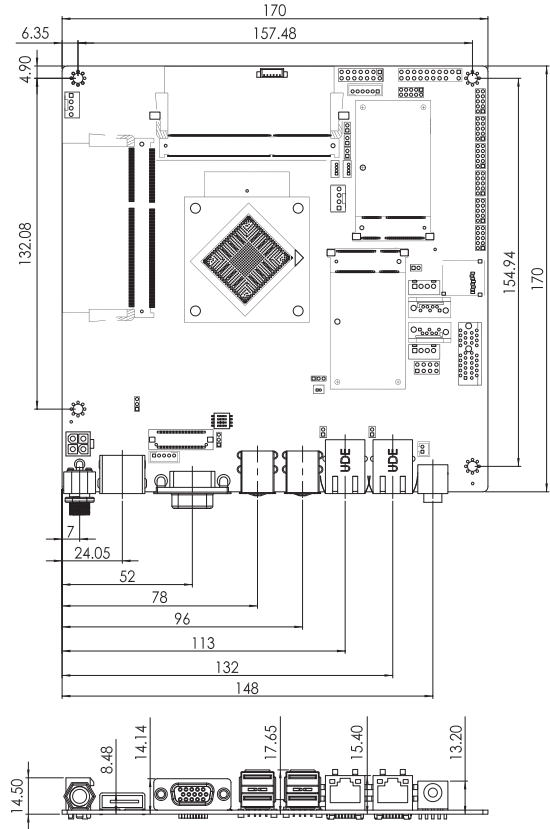

KINO-AQ170

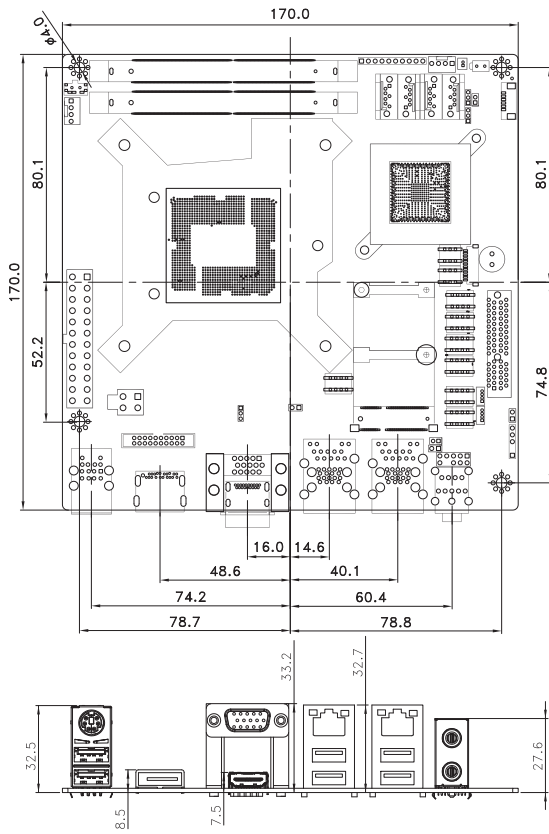

KINO-DBT

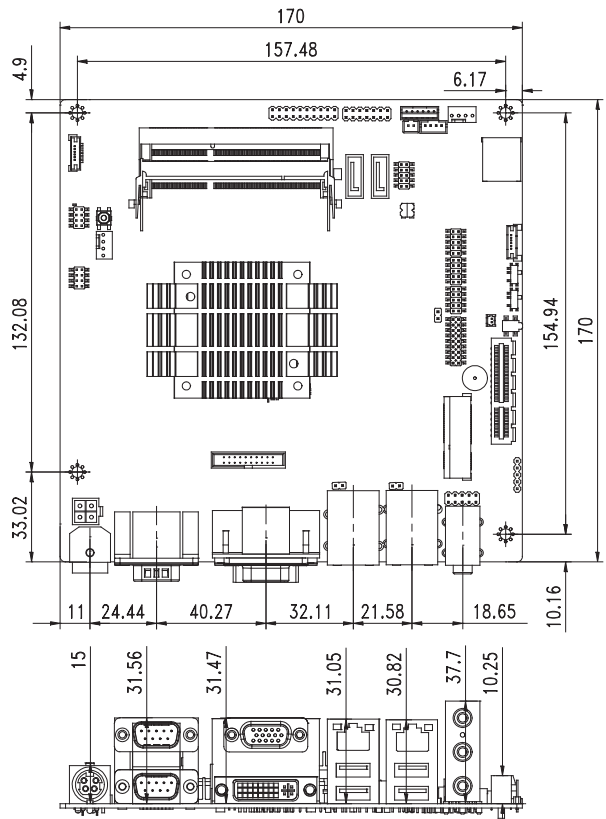

Mini-ITX Dimensions (Unit: mm)

