

Accelerate to The Future

PEMUX Introduction

The PEMUX allows users to deliver with maximum 56 lane of PCI Express 3.0 to PEMUX backplane while taking advantage of the speed and increased bandwidth of PCI Express.

■ What is PEMUX ?

- **Bringing PCI Express to your SBC with maximum lane signal quantity, increased speed and bandwidth**
PEMUX is designed for AI computing usage. AI computing needs to expand accelerator card, and PEMUX can provide up to 56 lane PCIe signals to the backplane.
All PCIe signal connect to CPU directly, this is perfect for applications that require minimal latency.
- **New pin definition for PCIe signal pass through to backplane**
With the maximization of PCIe lane signal quantity, we need the brand new pin define for supporting all signals pass through to the backplane, we called PEMUX design which defined by IEI.

■ The Advantage of PEMUX

- Maximum 56 lane PCIe signals signals to fulfill AI deep learning or inference demand
- IPMI remote management

■ The Benefits of PEMUX

- With the backplane can expand up to 4 dual width graphics cards
- Use Intel® Xeon W High performance processor

■ Full-size PEMUX PCIe Slot Configuration

Full-size SBC Type			Server & Graphic Grade	
Combination			A	B
PCIe Slots Available (non switch)	CPU	x16		2
		x8	4	
		x4	4	4
	PCH	x4	2	2
Backplane Solution			PEMUX-DB series	

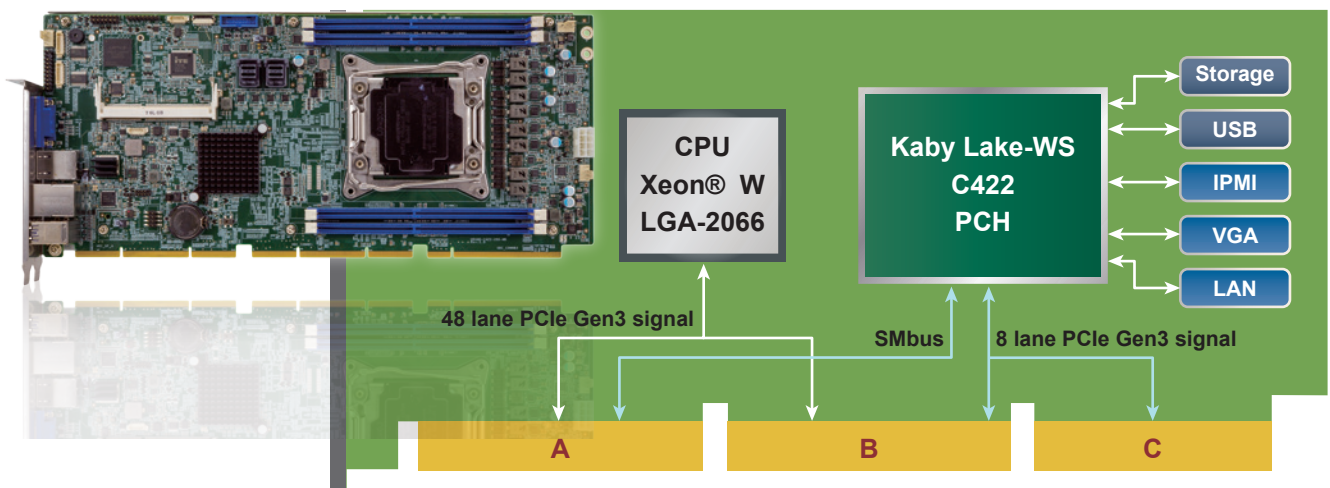

PEMUX-XEW1

Full-size PEMUX CPU Card supports LGA2066 Intel® Xeon® W CPU per, Intel® C422, DDR4 ECC RDIMM, IPMI VGA output, Aquantia 10GbE, USB 3.1 Gen 1 (5Gb/s), SATA 6Gb/s, M.2 and RoHS

New

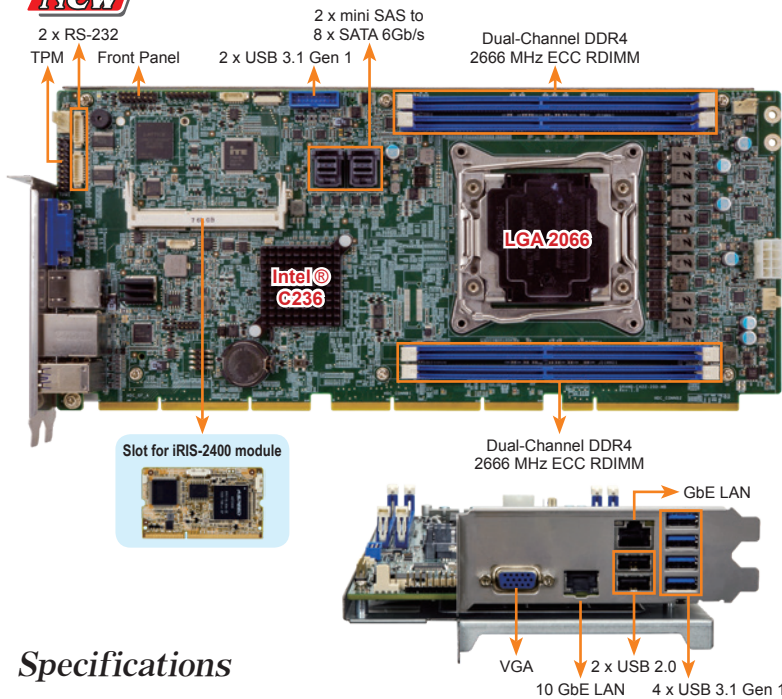

Specifications

- ◆ Form Factor
PEMUX Full-size CPU card (12 layers)
- ◆ CPU
LGA2066 socket supports Intel® Xeon W processor
- ◆ Chipset
Intel® C422
- ◆ Memory
Four 288-pin Dual-Channel DDR4 ECC RDIMM/LRDIMM supported up to 256GB
- ◆ BIOS
UEFI BIOS
- ◆ Super I/O
Fintek F81216D
- ◆ EC
iWDD
- ◆ Display Output
1 x IPMI VGA display
- ◆ Ethernet
LAN1: 1 GbE NIC: Intel® i210-AT with NCSI support
LAN2: 10 GbE NIC: Aquantia AQC107
- ◆ External I/O Interface
2 x USB 2.0
4 x USB 3.1 Gen 1 (5Gb/s)
- ◆ Internal I/O Interface
1 x M.2 2280
1 x USB DOM header
2 x mini SAS 8643 (for 8 x SATA 6Gb/s)
2 x RS-232 by pin header
2 x USB 3.1 Gen 1 (5Gb/s) pin header
- ◆ Front Panel
1 x Front Panel (Power LED, HDD LED, Speaker, Power Button, Reset Button)
- ◆ Audio
2 x 5-pin pin header
- ◆ TPM
2 x 10-pin pin header
- ◆ SMBus
1 x SMBus to backplane
- ◆ Expansion
56-Lane PCIe signal via golden finger
- ◆ Watchdog Timer
software Programmable support 1~255 sec. System reset
- ◆ Fan Connector
1 x 4-pin Smart fan connector (CPU fan)
2 x 4-pin Smart fan connector (System CPU fan)
- ◆ Power Supply
5V/12V, AT/ATX support
- ◆ Operating Temperature
-20°C ~ 40°C
- ◆ Operating Humidity
5% ~ 95%, non-condensing
- ◆ Dimensions
338.58 mm x 150.5 mm
- ◆ Weight
700g

LGA 2066

Support Intel® Xeon W series CPU

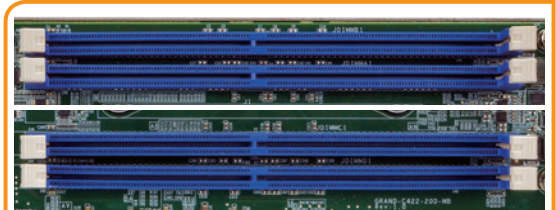
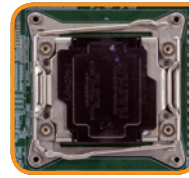

Four 288-pin DDR4 ECC RDIMM/LRDIMM Supported

Four 288-pin 2666MHz dual-channel DDR4 SDRAM ECC RDIMM / LRDIMM (system max.256GB) supports in IEI full-size server grade CPU card.



PEMUX can provide up to 56 lane PCIe signals to the backplane. With the maximization of PCIe lane signal quantity, we need the brand new pin define for supporting all signals pass through to the backplane, we called PEMUX design which defined by IEI.



TPM 2.0 Support



Features

- PEMUX full-size server / graphic grade solution
- LGA2066 socket supports Intel® Xeon W processor
- Four 288-pin Dual-Channel DDR4 ECC RDIMM/LRDIMM supports up to 256GB
- Supports IPMI VGA display.
- Supports M.2 2280 SSD
- Intel® PCIe GbE Intel® i210-AT with NCSI support
- Aquantia AQC107 10 GbE NIC
- Supports RAID function via SATA 6Gb/s
- TPM V2.0 hardware security function supported by TPM module

Packing List

- 1 x PEMUX-XEW1 single board computer
- 1 x mini SAS to 4 SATA cable
- 1 x QIG (Quick Installation Guide)

Ordering Information

Part No.	Description
PEMUX-XEW1-R10	Full-size PEMUX CPU Card supports LGA2066 Intel® Xeon® W C422, DDR4 ECC RDIMM/LRDIMM, VGA, Intel® PCIe GbE, Aquantia 10GbE, USB 3.1 Gen 1 (5Gb/s), USB 2.0, SATA 6Gb/s, HD Audio, IPMI and RoHS
32102-000100-200-RS	SATA Power Cable
CF-2011B-RS	High performance LGA1355/1356/2011 cooler kit, 130W
iRIS-2400-R10	IPMI 2.0 adapter card with AST2400 BMC chip for DDR3 SO-DIMM socket interface
32037-000600-100-RS	1 x mini SAS to 4 SATA Cable
32005-005000-100-RS	RS-232 cable

PEMUX Backplane

Accelerate to The Future

Server grade backplane accommodates multiple PCIe x8 and PCIe x4 add-on cards. It is specially designed for intensive AI computing applications such as deep learning and inference engine that requires more numbers of PCIe slot for accelerator cards. Given the multiple PCIe slots support, it provides a more efficiency solution for end-users.

Selection Guide

 4U rack-mount chassis

Backplane		PEMUX-DB-10S1	PEMUX-DB-8S1
Total	Slot	11	9
PCIe	x16		2
	x8	4	
	x4	6	6
	x1		
PSU type		24+8pin ATX	24+8pin ATX
Chsaais Option		RACK-305G RACK-360G RACK-3000G	RACK-305G RACK-360G RACK-3000G

PEMUX-DB-8S1-R10

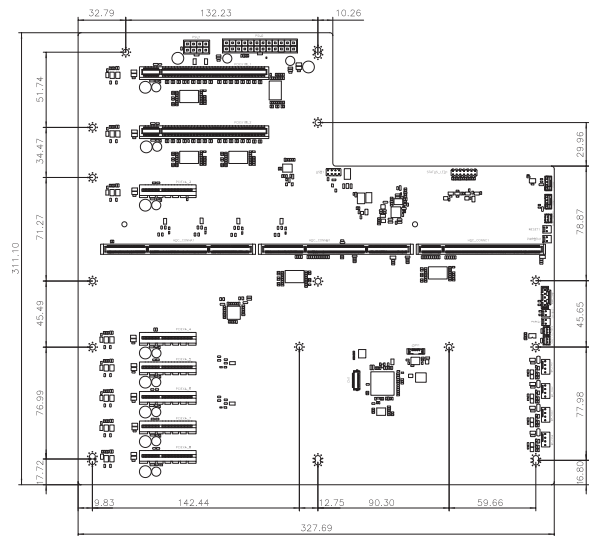
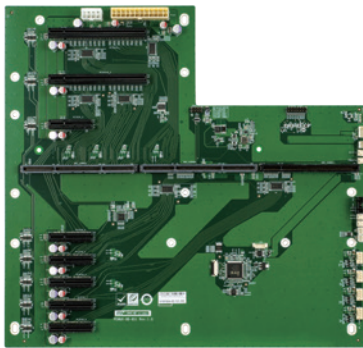

Ordering Information

PEMUX-DB-8S1-R10	1-Slot PEMUX backplane, 2 PCIe Gen 3.0 x16 w/ x16 slot,6 PCIe Gen3.0 x4 w/ x4 slots, and RoHS
RACK-305G	4U 14-slot full-size rack-mount chassis
RACK-360G	4U 14-slot full-size rack-mount chassis
RACK-3000G	4U 14-slot full-size rack-mount chassis

PEMUX-DB-10S1-R10

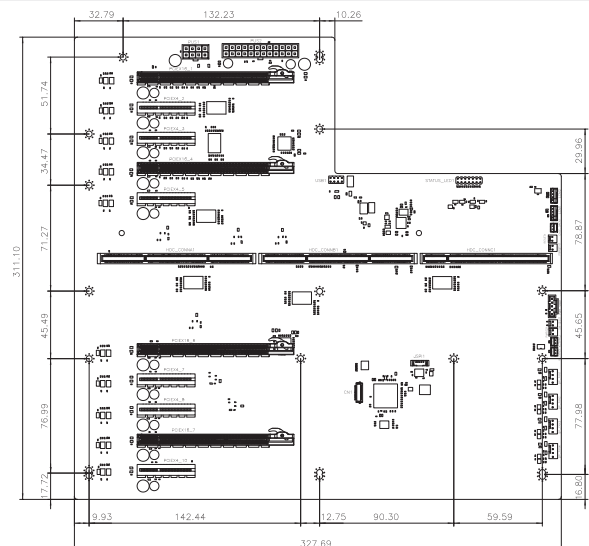
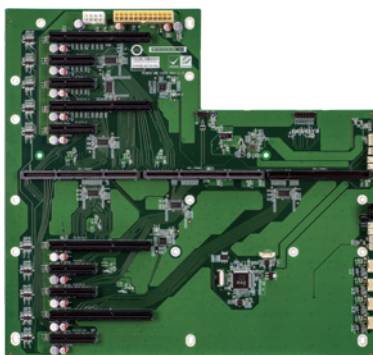

Ordering Information

PEMUX-DB-10S1-R10	1-Slot PEMUX backplane, 4 PCIe Gen 3.0 x8 w/ x16 slot,6 PCIe Gen3.0 x4 w/ x4 slots, and RoHS
RACK-305G	4U 14-slot full-size rack-mount chassis
RACK-360G	4U 14-slot full-size rack-mount chassis
RACK-3000G	4U 14-slot full-size rack-mount chassis

PICMG 1.3

The PICMG 1.3 allows users to protect their investment in PCI technology while taking advantage of the speed and increased bandwidth of PCI Express

What is PICMG 1.3 ?

- Bringing PCI Express to your SBC with increased speed and bandwidth**
 PICMG 1.3 is designed to interface with PCI Express peripherals on a backplane. The PCI Express interconnects with the backplane and can operate at x1, x4, x8, x16, and more, depending on the capabilities of both the SHB and the backplane.
- Support PCI on board with flexibility**
 The optional PCI portion of the SHB interconnected with the backplane allows for 32-bit operation. The clock rate can be 33 MHz, 66 MHz, 100 MHz, and 133 MHz, depending on how the backplane and SHB are designed.
- Miscellaneous IO**
 SATA, USB, IPMB, SMBus, Geographic Addressing, and PCI Wake Up to the backplane are specified, simplifying the cabling on SHB for the system.

PICMG 1.3 Key Features

- PCI Express**
 20 PCI Express lanes are supported, including PCI Express x16, x4 and x1 configurations
- ATX power signals are supported**
 Provides AUX voltages for standby power and sleep states (soft starts, wake on LAN), supports PSON#, PWRGD, PWRRBT# and ACPI states

Why PICMG 1.3?

- This new technology is expected to allow PCIe transmission rates to keep pace with processor and I/O advances for the next 10 years or more.
- Same basic mechanical dimensions are maintained to minimize chassis redesign expense
- Better host board power management and simplified I/O cabling
- Supports PCI Express and PCI option cards without driver changing

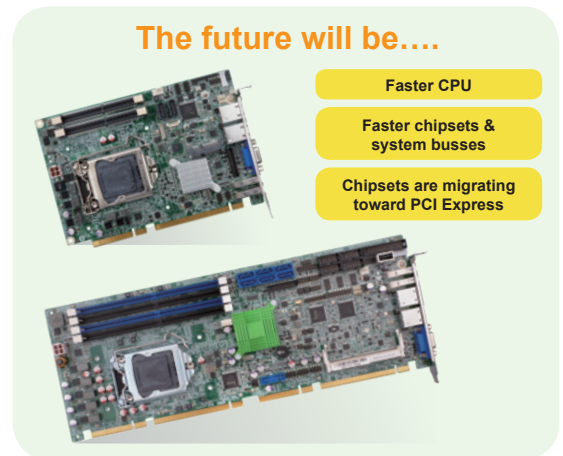

Graphic & Server Grade PICMG 1.3 Solutions

Full-size PICMG 1.3 Solutions

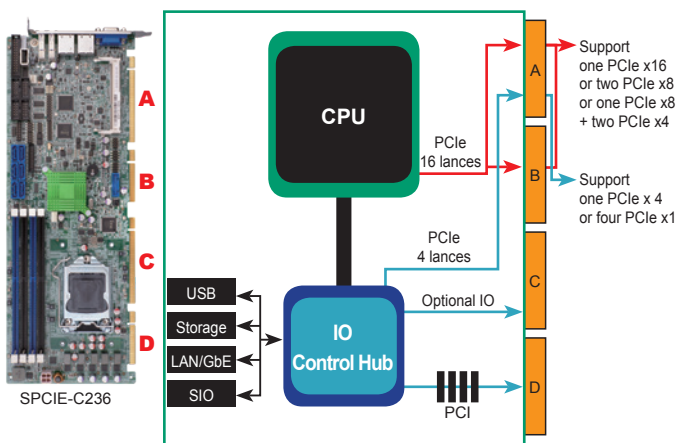

Half-size PICMG 1.3 Solutions

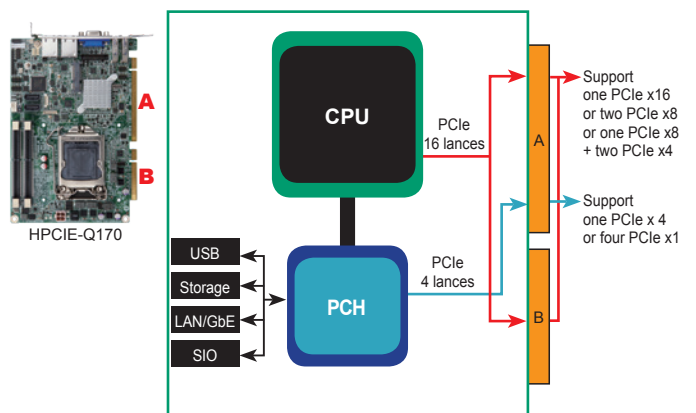

Full-Size PICMG 1.3 PCIe Slot Configuration

Full-size SBC Type		Server & Graphic Grade		Server Grade			
Combination		A	B	C	D	E	F
PCIe Slots Available (Non-switch)	CPU	x16	1	1	-	-	-
		x8	-	-	2	2	1
		x4	-	-	-	-	2
	PCH	x4	-	1	-	1	-
		x1	4	-	4	-	4
Backplane Solution		IEI PE/PXE series		IEI SPE/SPXE series			

Half-Size PICMG 1.3 PCIe Slot Configuration

Half-size SBC Type		Any Type		High Performance			
Combination		A	B	C	D	E	F
PCIe Slots Available (Non-switch)	CPU	x16	1	1	-	-	-
		x8	-	-	2	2	1
		x4	-	-	-	-	2
	PCH	x4	-	1	-	1	-
		x1	4	-	4	-	4

PICMG 1.3 Selection Guide



Preliminary

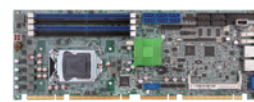

Model Name	HPCIE-C236	HPCIE-Q170	SPCIE-C246	SPCIE-C236
CPU Socket	LGA 1151	LGA 1151	LGA1151	LGA1151
CPU Type	Intel® Xeon® E3, Core™ i3, Pentium®, Celeron® processor	Intel® Core™ i7/i5/i3, Pentium®, Celeron® processor	Intel® Xeon® E3, Core™ i7/i5/i3, Pentium® or Celeron® processor	Intel® Xeon® E3, Core™ i3, Pentium®, Celeron® processor
Chipset	Intel® C236	Intel® Q170	Intel® C246	Intel® C236
Memory	Two 260-pin 1866/2133 MHz dual-channel DDR4 SO-DIMMs (system max. 32 GB)	Two 260-pin 1866/2133 MHz dual-channel DDR4 SO-DIMMs (system max. 32 GB)	Four 288-pin 2666MHz dual-channel DDR4 SDRAM unbuffered DIMMs support up to 64GB ECC & non-ECC	Four 288-pin 1866/2133 MHz Dual-Channel DDR4 ECC & non-ECC unbuffered DIMM supported up to 64GB
Display Interface	Dual display supported 1 x VGA 1 x iDP interface	Dual display supported 1 x VGA 1 x iDP interface	Dual display supported 1 x HDMI 1 x DP	Triple display supported 1 x VGA 1 x iDP interface
Ethernet	LAN1: Intel® I219-LM with Intel® AMT 11.0 support LAN2: Intel® I211-AT Ethernet controller	LAN1: Intel® I219-LM with Intel® AMT 11.0 support LAN2: Intel® I211-AT Ethernet controller	LAN1: Intel® I219LM PHY LAN2: Intel® I211-AT PCIe controller (Co-layer I210-AT)	LAN1: Intel® I219LM Clarkville-V with Intel® AMT 11.0 supported LAN2: Intel® I210 PCIe controller
iRIS Remote Management Module	N/A	N/A	N/A	1 x iRIS-2400 slot (Optional)
I/O Interface	1 x 6-pin wafer for KB/MS 2 x RS-232/422/485 2 x USB 3.1 Gen 1 4 x USB 2.0	1 x 6-pin wafer for KB/MS 2 x RS-232/422/485 2 x USB 3.1 Gen 1 4 x USB 2.0	1 x 6-pin wafer for KB/MS 1 x RS-422/485 3 x RS-232 4 x USB 3.1 Gen 1 7 x USB 2.0	1 x 6-pin wafer for KB/MS 1 x LPT 2 x RS-232 2 x RS-232/422/485 4 x USB 3.1 Gen 1 7 x USB 2.0
Storage Interface	1 x mSATA (SATA & USB signal) 2 x SATA 6Gb/s (RAID 0/1 supported)	1 x mSATA (SATA & USB signal) 2 x SATA 6Gb/s (RAID 0/1 supported)	6 x SATA 6Gb/s (RAID 0/1/5/10 supported)	6 x SATA 6Gb/s (RAID 0/1/5/10 supported)
Audio	Supports by IEI AC-KIT-892HD-R10 audio kit			
Digital I/O	8-bit programmable digital I/O			
Power Consumption	5V@0.13A, 12V@7.89A, 3.3V@0.10A, 5VSB@0.20A (Intel® Xeon® E3-1275 v5 3.60 GHz with two 16 GB 2133 MHz DDR4 memory)	5V@0.15A, 12V@8.39A, 3.3V@0.11A, 5VSB@0.21A (Intel® Core™ i7-6700K 4.0GHz with two 16 GB 2133 MHz DDR4 memory)	TBD	5V@3.22A, 12V@6.81A, 3.3V@1.21A, 5VSB@0.18A (Intel® Xeon® E3-1275 v5 3.60 GHz CPU with 64GB (four 16GB) 2133 MHz DDR4 memory)
Watchdog Timer	Software programmable supports 1~255 sec. system reset			
Operation Environment	Temperature Range: -20°C ~ 60°C (-4°F ~ 140°F) Relative Humidity: 5% ~ 95%, non-condensing			
Expansion Slot	N/A	N/A	1 x M.2 M key 1 x PCIe x16 & 4 x PCIe x1 signal via golden finger 4 x PCI signal via golden finger	1 x Full-size PCIe Mini card slot (support mSATA)
CPU Cooler	CF-1150SB-R11 CF-1150SC-R20 CF-1150SE-R11	CF-1150SB-R11 CF-1150SC-R20 CF-1150SE-R11	CF-1150SB-R11 CF-1150SC-R20 CF-1150SE-R11	CF-1150SB-R11 CF-1150SC-R20 CF-1150SE-R11

PICMG 1.3 Selection Guide

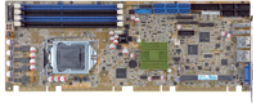



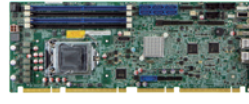

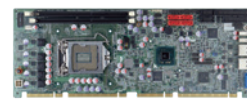
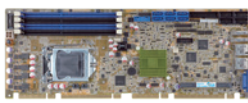
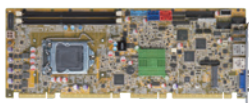

Model Name	SPCIE-C2260-i2	SPCIE-C2060-R21	PCIE-Q370	PCIE-Q170
CPU Socket	LGA 1150	LGA 1155	LGA1151	LGA1151
CPU Type	Intel® Xeon® E3, Core™ i3, Pentium®, Celeron® processor	Intel® Xeon® E3, Core™ i3, Pentium®, Celeron® processor	8th generation Intel® Core® i7/i5/i3, Pentium® or Celeron® processor	6th generation Intel® Core™ i7/i5/i3, Celeron® and Pentium® processor
Chipset	Intel® C226	Intel® C206	Intel® Q370	Intel® Q170
Memory	Four 240-pin 1600/1333 MHz dual-channel DDR3 & DDR3L SDRAM unbuffered DIMMs (system max. 32 GB)	Two 240-pin 1333/1066 MHz dual-channel ECC and non-ECC unbuffered DDR3 SDRAM DIMMs (system max.16 GB)	Four 288-pin 2666MHz dual-channel DDR4 SDRAM unbuffered DIMMs support up to 64GB	Four 288-pin 1866/2133 MHz dual-channel non-ECC unbuffered DDR4 DIMMs (system max. 64 GB)
Display Interface	Dual display supported 1 x VGA 1 x iDP interface	1 x VGA 1 x DVI-D (via header to IO-KIT-001-R20 DVI-D/USB module) (optional)	Dual display supported 1 x VGA 1 x DP	Triple display supported 1 x VGA 1 x iDP interface
Ethernet	LAN1: Intel® I217LM with Intel® AMT 9.0 support LAN2: Intel® I210-AT PCIe controller with NCSI support	LAN1: Intel® 82574L PCIe controller LAN2: Intel® 82579 PHY with Intel® AMT 7.0 support	LAN1: Intel® I219LM PHY LAN2: Intel® I211-AT PCIe controller (Co-lay I210-AT)	LAN1: Intel® I219LM Clarkville-V with Intel® AMT 11.0 supported LAN2: Intel® I210 PCIe controller
iRIS Remote Management Module	1 x iRIS-2400 slot	N/A	N/A	1 x iRIS-2400 slot (optinoal)
I/O Interface	1 x 6-pin wafer for KB/MS 1 x LPT 1 x RS-422/485 4 x RS-232 4 x USB 3.1 Gen 1 8 x USB 2.0	1 x 6-pin wafer for KB/MS 1 x LPT 1 x RS-422/485 4 x RS-232 8 x USB 2.0	1 x 6-pin wafer for KB/MS 1 x RS-422/485 3 x RS-232 4 x USB 3.1 Gen 1 7 x USB 2.0	1 x 6-pin wafer for KB/MS 1 x LPT 2 x RS-232 2 x RS-232/422/485 4 x USB 3.1 Gen 1 7 x USB 2.0
Storage Interface	6 x SATA 6Gb/s (RAID 0/1/5/10 supported)	2 x SATA 6Gb/s (RAID 0/1/5/10 supported) 4 x SATA 3Gb/s	6 x SATA 6Gb/s (RAID 0/1/5/10 supported)	6 x SATA 6Gb/s (RAID 0/1/5/10 supported)
Audio	Supports by IEI AC-KIT-892HD-R10 audio kit			
Digital I/O	8-bit programmable digital I/O			
Power Consumption	5V@3.55A, 12V@0.37A, Vcore_12V@7.61A, 3.3V@1.55A, 5VSB@0.13A (Intel® E3-1240 v3 3.4GHz CPU with 16 GB (four 4GB) 1333 MHz DDR3 memory)	5V@3.98A, 12V@0.38A, Vcore_12V@7.81A, 3.3V@1.61A, 5VSB@0.15A (3.4GHz Intel® Core™ i7-2600K with two 2 GB 1333 MHz DDR3 memory)	5V@3.12A, 12V@6.85A, 3.3V@1.13A, 5VSB@0.15A (4.0 GHz Intel® Core™ i7-8700K CPU with four 16 GB 2666 MHz DDR4 memory)	5V@3.12A, 12V@6.85A, 3.3V@1.13A, 5VSB@0.15A (Intel® Core™ i7-6700K 4.0GHz CPU with 64GB (four 16GB) 2133 MHz DDR4 memory)
Watchdog Timer	Software programmable supports 1~255 sec. system reset			
Operation Environment	Temperature Range: -20°C ~ 60°C (-4°F ~ 140°F) Relative Humidity: 5% ~ 95%, non-condensing	Temperature Range: -10°C ~ 60°C (14°F ~ 140°F) Relative Humidity: 5% ~ 95%, non-condensing	Temperature Range: -20°C ~ 60°C (-4°F ~ 140°F) Relative Humidity: 5% ~ 95%, non-condensing	
Expansion Slot	1 x Full-size PCIe Mini card slot (support mSATA)	1 x Full-size PCIe Mini card slot	1 x M.2 M key 1 x PCIe x16 & 4 x PCIe x1 signal via golden finger 4 x PCI signal via golden finger	1 x Full/Half-size PCIe Mini card slot 4 x PCI signal via golden finger
CPU Cooler	CF-1150SB-R11 CF-1150SC-R20 CF-1150SE-R11 CF-1150SF-R10	CF-115XA-R10 CF-1156C-R20 CF-1156D-R20 CF-115XE-R10	CF-1150SB-R11 CF-1150SC-R20 CF-1150SE-R11	CF-1150SB-R11 CF-1150SC-R20 CF-1150SE-R11

PICMG 1.3 Selection Guide



Model Name	PCIE-H810	PCIE-Q870-i2	PCIE-Q670-R20	PCIE-H610
CPU Socket	LGA 1150	LGA 1150	LGA 1155	LGA 1155
CPU Type	Intel® Core™ i7/i5/i3, Pentium®, Celeron® processor	Intel® Core™ i7/i5/i3, Pentium®, Celeron® processor	Intel® Core™ i7/i5/i3, Pentium®, Celeron® processor	Intel® Core™ i7/i5/i3, Pentium®, Celeron® processor
Chipset	Intel® H81	Intel® Q87	Intel® Q67	Intel® H61
Memory	Two 240-pin 1600/1333 MHz dual-channel DDR3 & DDR3L SDRAM unbuffered DIMMs (system max. 16 GB)	Four 240-pin 1600/1333 MHz dual-channel DDR3 & DDR3L SDRAM unbuffered DIMMs (system max. 32 GB)	Two 240-pin 1333/1066 MHz dual-channel DDR3 SDRAM DIMMs (system max. 16 GB)	Two 240-pin 1333/1066 MHz dual-channel DDR3/DDR3L (1.35V) SDRAM DIMMs (system max. 16 GB)
Display Interface	Dual display supported 1 x VGA 1 x iDP interface	Dual display supported 1 x VGA 1 x iDP interface	1 x VGA 1 x DVI-D (via header to IO-KIT-001-R20 DVI-D/USB module) (optional)	1 x VGA 1 x DVI-D (via header to IO-KIT-001-R20 DVI-D/USB module) (optional)
Ethernet	LAN1: Realtek RTTL8111E PCIe controller LAN: Realtek RTTL8111E PCIe controller	LAN1: Intel® I217LM with Intel® AMT 9.0 support LAN2: Intel® I210-AT PCIe controller with NCSI support	LAN1: Intel® 82583V PCIe controller LAN2: Intel® 82579 PHY with Intel® AMT 7.0 support	LAN1: Realtek RTL8111E PCIe GbE controller with ASF 2.0 support LAN2: Realtek RTL8111E PCIe GbE controller
iRIS Remote Management Module	N/A	1 x iRIS-2400 slot	N/A	
I/O Interface	1 x 6-pin wafer for KB/MS 1 x LPT 1 x RS-422/485 2 x RS-232 2 x USB 3.1 Gen 1 8 x USB 2.0	1 x 6-pin wafer for KB/MS 1 x LPT 1 x RS-422/485 4 x RS-232 4 x USB 3.1 Gen 1 8 x USB 2.0	1 x 6-pin wafer for KB/MS 1 x LPT 1 x RS-422/485 4 x RS-232 8 x USB 2.0	1 x 6-pin wafer for KB/MS 1 x FDD 1 x LPT 1 x RS-422/485 2 x RS-232 10 x USB 2.0
Storage Interface	2 x SATA 3Gb/s 2 x SATA 6Gb/s	6 x SATA 6Gb/s (RAID 0, 1, 5, 10 supported)	2 x SATA 6Gb/s (RAID 0/1/5/10 supported) 4 x SATA 3Gb/s	4 x SATA 3Gb/s
Audio	Supports by IEI AC-KIT-892HD-R10 audio kit	IEI AC-KIT-892HD-R10 7.1-channel HD Audio kit via the on-board 10-pin header connector		
Digital I/O	8-bit programmable digital I/O			
Power Consumption	5V@3.41A, 12V@0.35A, Vcore_12V@7.52A, 3.3V@1.41A, 5VSB@0.12A (Intel® Core™ i7-4770K 3.90 GHz CPU with 8 GB (two 4 GB) 1333 MHz DDR3 memory)	5V@3.55A, 12V@0.37A, Vcore_12V@7.61A, 3.3V@1.55A, 5VSB@0.13A (3.4GHz Intel® Qual CoreCPU with four GB 1333 MHz DDR3 memory)	5V@3.98A, 12V@0.38A, Vcore_12V@7.81A, 3.3V@1.61A, 5VSB@0.15A (3.4GHz Intel® Core™ i7-2600K with two 2 GB 1333 MHz DDR3 memory)	5V@4.41A, 12V@0.21A, Vcore_12V@7.72A, 3.3V@1.71A, 5VSB@0.16A (3.4GHz Intel® Core™ i7-2600K with two 2 GB 1333 MHz DDR3 memory)
Watchdog Timer	Software programmable supports 1~255 sec. system reset			
Operation Environment	Temperature Range: -20°C ~ 60°C (-4°F ~ 140°F) Relative Humidity: 5% ~ 95%, non-condensing		Temperature Range: -10°C ~ 60°C (14°F ~ 140°F) Relative Humidity: 5% ~ 95%, non-condensing	
Expansion Slot	1 x Full-size PCIe Mini card slot (support mSATA)	1 x Full-size PCIe Mini card slot (support mSATA)		N/A
CPU Cooler	CF-1150SB-R11 CF-1150SC-R20 CF-1150SE-R11 CF-1150SF-R10	CF-1150SB-R11 CF-1150SC-R20 CF-1150SE-R11 CF-1150SF-R10	CF-115XA-R10 CF-1156C-R20 CF-1156D-R20 CF-115XE-R10	CF-115XA-R10 CF-1156C-R20 CF-1156D-R20 CF-115XE-R10

HPCIE-Q170

Half-size PICMG 1.3 CPU Card supports LGA 1151 Intel® Core™ i7/i5/i3, Pentium® or Celeron® CPU with Intel® Q170, DDR4 SO-DIMM, VGA/iDP, Dual Intel® PCIe GbE, USB 3.1 Gen 1 (5Gb/s), SATA 6Gb/s, mSATA, HD Audio, Intel® AMT and RoHS

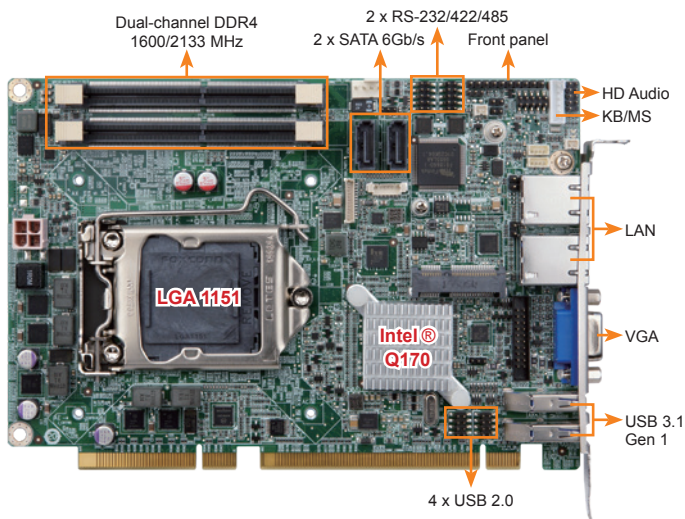

Specifications

- ◆ CPU
LGA 1151 socket supports Intel® 6th/7th generation Core™ i7/i5/i3, Pentium® or Celeron® processor
- ◆ Chipset
Intel® Q170
- ◆ Memory
Two 260-pin 1866/2133 MHz dual-channel DDR4 non-ECC unbuffered SO-DIMMs support up to 32 GB
- ◆ BIOS
UEFI BIOS
- ◆ Graphics Engine
Intel® HD Graphics Gen 9 supports DX11/12, OpenCL 2.x and OpenGL 4.3/4.4 Decode/Encode for HEVC, VP8, VP9, VDENC
- ◆ Display Output
1 x VGA (up to 1920x1200@60 Hz)
1 x iDP interface for HDMI, LVDS, VGA, DVI, DP (up to 3840x2160@60 Hz)
- ◆ Ethernet
LAN1: Intel® I219LM Clarkville-V with Intel® AMT 11.0 support
LAN2: Intel® I211 PCIe controller
- ◆ External I/O Interface
2 x USB 3.1 Gen 1 (5Gb/s)
- ◆ Internal I/O Interface
1 x KB/MS (1x6 pin)
1 x mSATA (SATA & USB signal)
2 x RS-232/422/485 (2x5 pin, P=2.0)
- ◆ Front Panel
1 x Front panel (1x10 pin, power LED, HDD LED, speaker, power button, reset button)
- ◆ LAN LED
2 x LAN LED (1x2 pin)
- ◆ Audio
Support 7.1-channel HD Audio by IEI AC-KIT-892HD kit
- ◆ SMBus
1 x SMBus (1x4 pin)
- ◆ I²C
1 x I²C (1x4 pin)
- ◆ Expansion
16-lane PCIe signal from CPU via golden finger (supports x16, or x8 + x8, or x4 + x4 + x8)
4-lane PCIe signal from Q170 via golden finger
1 x Full/Half-size PCIe Mini card slot (supports mSATA)
- ◆ Watchdog Timer
Software programmable supports 1~255 sec. system reset
- ◆ Digital I/O
8-bit digital I/O (2x5 pin)
- ◆ Fan Connector
1 x CPU smart fan (1x4 pin)
- ◆ Power Supply
5V/12V, AT/ATX support
- ◆ Power Consumption
5V@0.15A, 12V@8.39A, 3.3V@0.11A, 5VSB@0.21A
(Intel® Core™ i7-6700K 4.0GHz with two 16 GB 2133 MHz DDR4 memory)
- ◆ Operating Temperature
-20°C ~ 60°C
- ◆ Operating Humidity
5% ~ 95%, non-condensing
- ◆ Dimensions
169 mm x 126 mm
- ◆ Weight
GW: 1000g / NW: 420g
- ◆ CE/FCC compliant

Intel® 6th generation Core™ CPU + Intel® Q170 support 3 controllers of PCI Express Gen 3

Number of PCIe Controller	Configuration
1	PCIe x16
2	PCIe x8, PCIe x8
3	PCIe x4, PCIe x4, PCIe x8

Sets PCIe x16 signal via BIOS

PEG port configuration	
USB Power SW1	[1 x8, 2 x4 PCIe]
USB Power SW2	[+5V DUAL]

PCIe Mini slot provides mSATA and USB signal for full-size or half-size mSATA SSD and wireless LAN card.

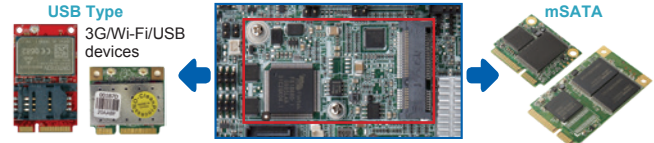

Features

- PICMG 1.3 half-size CPU card
- LGA 1151 Intel® 6th/7th generation Core™ i7/i5/i3, Pentium® or Celeron® processor supported
- Two 260-pin 1866/2133 MHz dual-channel DDR4 SO-DIMMs support up to 32 GB
- Supports dual independent display by VGA & internal DP pin header
- PCIe Mini card slot supports mSATA & USB 2.0
- Intel® PCIe GbE with Intel® AMT 11.0 supported
- Supports RAID 0, 1 function via SATA 6Gb/s
- IEI jumper-less function

Packing List

1 x HPCIE-Q170 single board computer
1 x SATA cable
1 x QIG

Ordering Information

Part No.	Description
HPCIE-Q170-R10	Half-size PICMG 1.3 CPU card supports LGA 1151 Intel® Core™ i7/i5/i3, Pentium® or Celeron® CPU with Intel® Q170, DDR4 SO-DIMM, VGA, iDP, dual Intel® PCIe GbE, SATA 6Gb/s, mSATA, USB 3.1 Gen 1 (5Gb/s), PCIe Mini, HD Audio, Intel® AMT and RoHS
19800-000075-RS	PS/2 KB/MS cable with bracket, 220mm, P=2.0
32102-000100-200-RS	SATA power cable, MOLEX 5264-4P to SATA15P
32205-002700-200-RS	RS-232/422/485 cable, 200mm, P=2.0
AC-KIT-892HD-R10	7.1-channel HD Audio kit with Realtek ALC892 supports dual audio streams
CF-115XA-R10	High-performance LGA 1155/LGA 1156 cooler kit, 1U chassis compatible, 73W
CF-1156C-R20	LGA 1155/LGA 1156 cooler kit, 1U chassis compatible, 45W
CF-1156D-R20	LGA 1155/LGA 1156 cooler kit, 1U chassis compatible, 65W
DP-DP-R10	DisplayPort to DisplayPort converter board (for IEI iDP connector)
DP-DVI-R10	DisplayPort to DVI-D converter board (for IEI iDP connector)
DP-HDMI-R10	DisplayPort to HDMI converter board (for IEI iDP connector)
DP-LVDS-R10	DisplayPort to LVDS converter board (for IEI iDP connector)
DP-VGA-R10	DisplayPort to VGA converter board (for IEI iDP connector)
SAIDE-KIT01-R10	SATA to IDE/CF converter board

PICMG 1.3 Passive Backplane for Half-Size CPU Card

Selection Guide

 PAC series wall-mount chassis

 4U rack-mount chassis

PICMG 1.3 (PCIe+PCI)	Model	HPXE2-5S1	HPXE2-6S1	HPXE2-7S1	HPXE2-8S1
Total Slot		5	6	7	8
Expansion Slots	PCIe x16	1	1		
	PCIe x8			2	2
	PCIe x4				
	PCIe x1				
	PCI-X				
	PCI	2	3	3	4
PSU Type		24+4-pin ATX	24+4-pin ATX	24+4-pin ATX	24+4-pin ATX
Chassis Option		PR-1500G	PAC-1000 PAC-106G	PAC-700G PAC-1700G	PAC-125G
		RACK-500G			RACK-3000G RACK-360G
Note		ATX power	ATX power	ATX power	ATX power

HPXE2-5S1-R10

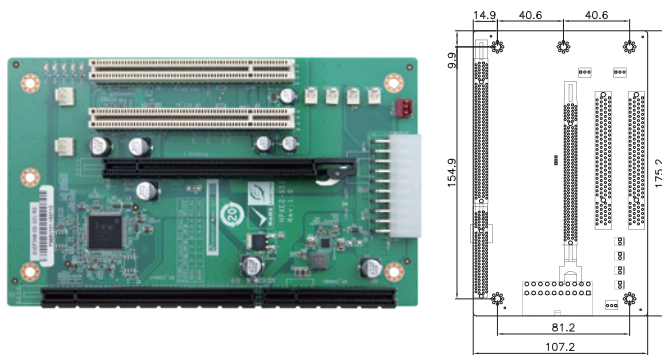

Ordering Information

HPXE2-5S1-R10 5-slot PICMG 1.3 backplane for half-size SBC, with two PCI slots and one PCIe x16 slot (x16 signal)

PR-1500G 5-slot half-size compact chassis

RACK-500G 5U 5-slot full-size rackmount chassis

HPXE2-7S1-R10

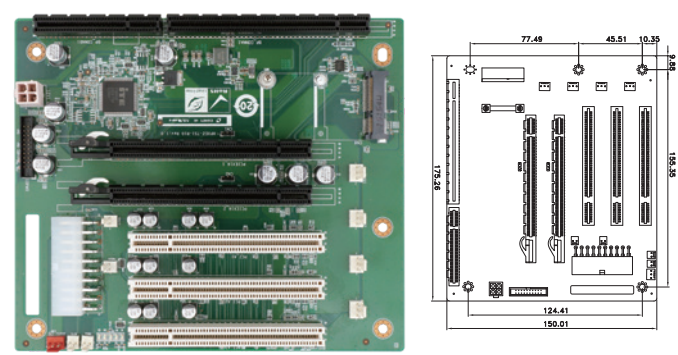

Ordering Information

HPXE2-7S1-R10 7-slot PICMG 1.3 backplane for half-size SBC, with three PCI slots and two PCIe x16 slots (x8 signal)

PAC-700G 7-slot half-size compact chassis

PAC-1700G 7-slot full-size compact chassis

HPXE2-6S1-R10

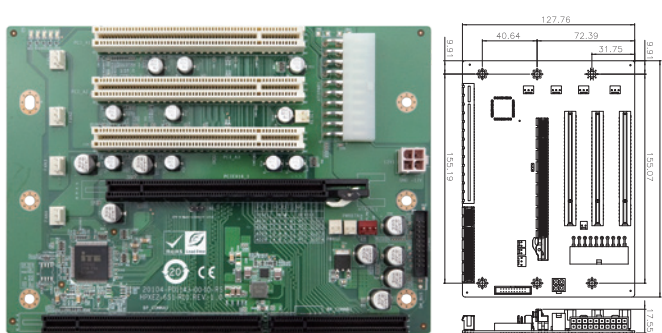

Ordering Information

HPXE2-6S1-R10 6-slot PICMG 1.3 backplane for half-size SBC, with three PCI slots and one PCIe x16 slot (x16 signal)

PAC-1000G 6-slot full-size compact chassis

PAC-106G 6-slot full-size compact chassis

HPXE2-8S1-R10

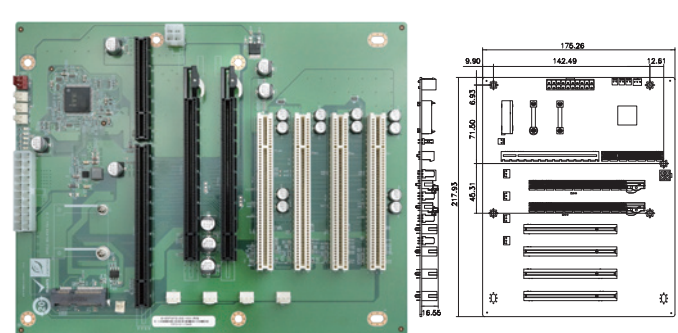

Ordering Information

HPXE2-8S1-R10 8-slot PICMG 1.3 backplane for half-size SBC, with four PCI slots and two PCIe x16 slot (x8 signal)

PAC-125G 10-slot full-size compact chassis

RACK-3000G 4U 14-slot full-size rack-mount chassis

RACK-360G 4U 14-slot full-size rack-mount chassis

SPCIE-C246

Full-size PICMG 1.3 CPU Card supports LGA1151 Intel® Xeon® E3, Core™ i7/i5/i3/ Pentium®/Celeron® CPU per Intel® C246, ECC & non-ECC DDR4, HDMI, DP, Dual Intel® PCIe GbE, USB 3.1 Gen 1 (5Gb/s), SATA 6Gb/s, M.2, HD Audio, Intel® AMT and RoHS

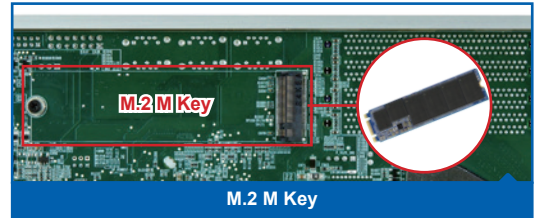
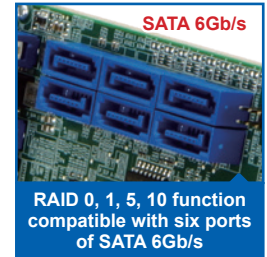
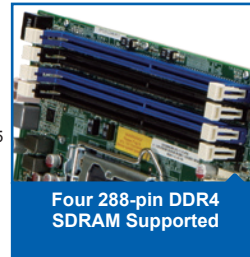
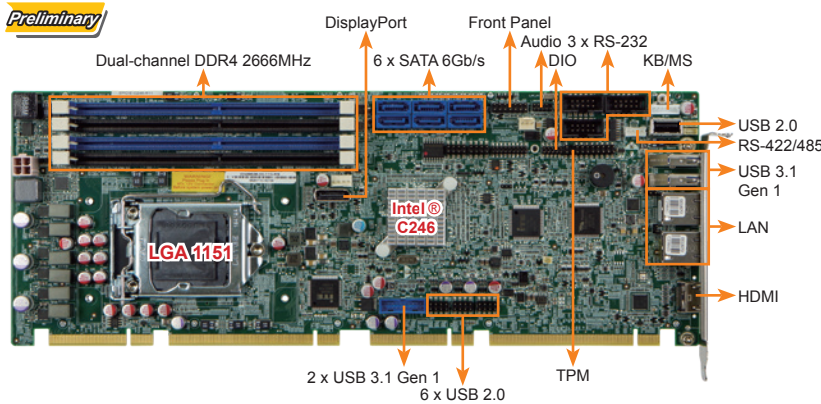

Specifications

- ◆ CPU
LGA1151 socket supports 8th generation Intel® Core® i7/i5/i3, Pentium® or Celeron® processor
- ◆ PCH
Intel® C246
- ◆ Memory
Four 288-pin 2666MHz dual-channel DDR4 SDRAM unbuffered DIMMs support up to 64GB ECC & non-ECC (C246)
- ◆ BIOS
AMI UEFI BIOS
- ◆ Graphic Engine
Intel® HD Graphics Gen 9 Engines with Low power 16 execution unit, supports DX2015, OpenGL 5.X and OpenCL2.x, ES 2.0
- ◆ Display Output
Dual display supported
1 x HDMI (up to 4096 x 2304@30Hz)
1 x DP (up to 4096 x 2304@60Hz)
- ◆ Ethernet
LAN1: Intel® I219LM PHY
LAN2: Intel® I211-AT PCIe controller (Co-lay I210-AT)
- ◆ Super I/O
Fintek F81866D
- ◆ Embedded Controller
EC IT8519
- ◆ External I/O Interface
2 x USB 3.1 Gen 1 (5Gb/s) (Rear IO type A)
1 x USB 2.0 (Type A 180°)
- ◆ Internal I/O Interface
1 x KB/MS (1x6 pin)
1 x RS-422/485 (1x4 pin, P=2.0)
2 x USB 3.1 Gen 1 (5Gb/s) (2x10 pin)
3 x RS-232 (2x5 pin, P=2.54)
6 x SATA 6Gb/s (RAID 0/1/5/10 supported)
6 x USB 2.0 (2x4 pin, P=2.54)
- ◆ Audio
Support 7.1 channel HD audio by IEI AC-KIT-892HD kit
- ◆ Front Panel
1 x Front panel (Power LED, HDD LED, Speaker, Power Button, Reset Button)
- ◆ LAN LED
2 x LAN LED (1x2 pin)
- ◆ TPM
1 x TPM (2x10 pin)
- ◆ SMBus
1 x SMBus (1x4 pin)
- ◆ I²C
1 x I²C (1x4 pin)
- ◆ Expansion
1 x M.2 M key
1 x PCIe x16 & 4 x PCIe x1 signal via golden finger
4 x PCI signal via golden finger
- ◆ Watchdog Timer
Software programmable support 1~255 sec. system reset
- ◆ Digital I/O
8-bit digital I/O (2x5 pin)
- ◆ FAN Connector
1 x CPU smart fan (1x4 pin)
1 x System smart fan (1x4 pin)
- ◆ Power Supply
AT/ATX power supply
Support AT/ATX mode
ErP/EuP Compliant
- ◆ Power Consumption
TBD
- ◆ Operating Temperature
-20°C ~ 60°C
- ◆ Operating Humidity
5% ~ 95%, non-condensing
- ◆ Dimensions: 338 mm x 126 mm
- ◆ Weight: GW: 1000g / NW: 500g
- ◆ I/O Shape: BK-114 (P/N: 45002-451803-00-RS)

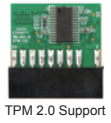

Features

- PICMG 1.3 full-size CPU card
- LGA1151 Intel® 8th Generation Core™ i7/i5/i3, Celeron® and Pentium® processor supported
- Dual-channel DDR4 2666MHz
- Support HDMI and DP display
- Intel® PCIe GbE with Intel® AMT 11.0 supported
- Support M.2 M key for storage (PCIe x4)
- Supports RAID 0, 1, 5, 10 function via SATA 6Gb/s

Packing List

- 1 x SPCIE-C246 single board computer
- 1 x Mini jumper pack
- 1 x SATA cable
- 1 x QIG (Quick Installation Guide)

Ordering Information

Part No.	Description
SPCIE-C246-R11	Full-size PICMG 1.3 CPU Card supports LGA1151 Intel® Xeon® E3, Core™ i7/i5/i3/Pentium®/Celeron® CPU per Intel® C246, ECC & non-ECC DDR4, HDMI, DP, Dual Intel® PCIe GbE, M.2, USB 3.1 Gen 1 (5Gb/s), SATA 6Gb/s, HD Audio, iAMT and RoHS
19800-000075-RS	PS/2 KB/MS cable with bracket, 220mm, P=2.0
32102-000100-200-RS	SATA power cable, MOLEX 5264-4P to SATA15P
AC-KIT-892HD-R10	7.1 channel HD Audio kit with Realtek ALC892 support dual audio streams
CF-1150SA-R10	Special cooler kit for LGA1150, High-performance compatible, 95W
CF-1150SB-R11	Special cooler kit for LGA1150, High-performance compatible, 65W
CF-1150SC-R20	Special cooler kit for LGA1150, 1U chassis compatible, 65W
CF-1150SE-R11	Special cooler kit for LGA1150, high-performance compatible, 95W
CF-1150SF-R10	Special cooler kit for LGA1150, 1U chassis compatible, 54W
SAIDE-KIT01-R10	SATA to IDE/CF Converter board

SPCIE-C2260-i2

Full-size PICMG 1.3 CPU Card supports LGA 1150 Intel® Xeon® E3, Core™ i3, Pentium® and Celeron® with Intel® C226, DDR3, VGA, iDP, Dual Intel® PCIe GbE, SATA 6Gb/s, mSATA, PCIe Mini, RS-232, HD Audio, iRIS-2400 and RoHS

PICMG 1.3 Server Grade Solution

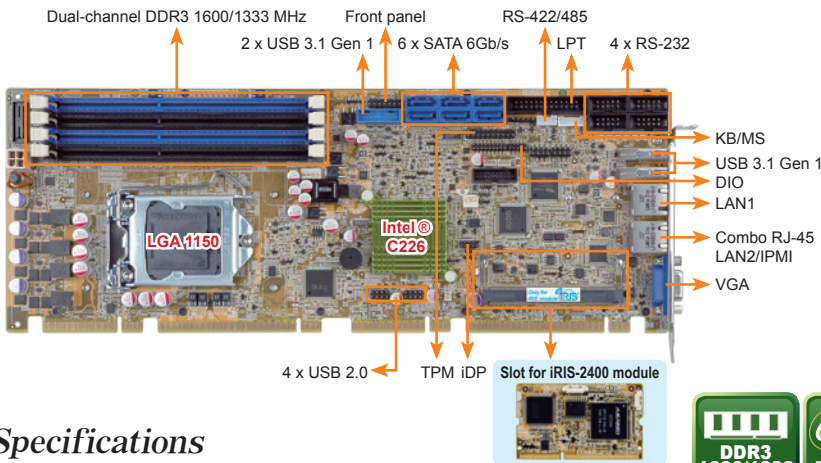

Specifications

- ◆ CPU
LGA 1150 Intel® Xeon® E3, Core™ i3, Pentium® or Celeron® processor supported
- ◆ Chipset
Intel® C226
- ◆ Memory
Four 240-pin 1600/1333 MHz dual-channel DDR3 & DDR3L SDRAM ECC and non-ECC unbuffered DIMMs support up to 32 GB
- ◆ BIOS
UEFI BIOS
- ◆ Graphics Engine
Intel® HD Graphics Gen 7.5 supports DX11.1 and OpenCL 1.2, OpenGL 3.2
Full MPEG2, VC1, AVC Decode
- ◆ Display Output
1 x VGA (up to 1920x1200@60 Hz)
1 x iDP interface for HDMI, LVDS, VGA, DVI, DP (up to 3840x2160@60 Hz)
- ◆ Ethernet
LAN1: Intel® I217LM with Intel® AMT 9.0 support
LAN2: Intel® I210-AT PCIe controller with NCSI support
- ◆ Audio
Supports 7.1-channel HD Audio by IEI AC-KIT-892HD-R10 kit
- ◆ External I/O Interface
2 x USB 3.1 Gen 1 (5Gb/s)
- ◆ Internal I/O Interface
1 x KB/MS (1x6 pin)
1 x LPT (2x13 pin)
1 x mSATA
1 x RS-422/485 (1x4 pin, P=2.0)
2 x USB 3.1 Gen 1 (5Gb/s) (2x10 pin)
4 x USB 2.0 (Golden finger)
4 x USB 2.0 (2x4 pin, P=2.54)
4 x RS-232 (2x5pin, P=2.54)
6 x SATA 6Gb/s (RAID 0/1/5/10 supported)
- ◆ LAN LED
2 x LAN LED (1x2 pin)
- ◆ TPM
1 x TPM (2x10 pin)
- ◆ SMBus
1 x SMBus (1x4 pin)
- ◆ I²C
1 x I²C (1x4 pin)
- ◆ Infrared Interface
1 x Infrared Interface (1x5 pin)
- ◆ Digital I/O
8-bit digital I/O (2x5 pin)
- ◆ Front Panel
1 x Front panel (2x7 pin, power LED, HDD LED, speaker, power button, reset button)
- ◆ iRIS Remote Management Module
1 x iRIS-2400 slot
- ◆ Expansion
PCIe signal and PCI signal via golden finger
1 x Full-size PCIe Mini card slot (colay mSATA)
- ◆ Watchdog Timer
Software programmable, supports 1~255 sec. system reset
- ◆ Fan Connector
1 x CPU smart fan (1x4 pin)
1 x System smart fan (1x3 pin)
- ◆ Power Supply
5V/12V, AT/ATX support
- ◆ Power Consumption
5V@3.55A, 12V@0.37A, Vcore_12V@7.61A, 3.3V@1.55A, 5VSB@0.13A (Intel® E3-1240 v3 3.4GHz CPU with 16 GB (four 4 GB) 1333 MHz DDR3 memory)
- ◆ Operating Temperature: -20°C ~ 60°C
- ◆ Storage Temperature: -30°C ~ 70°C
- ◆ Operating Humidity: 5% ~ 95%, non-condensing
- ◆ Dimensions: 338 mm x 126 mm
- ◆ Weight: GW: 1200g / NW: 420g
- ◆ CE/FCC compliant

Features

- PICMG 1.3 full-size server grade solution
- LGA 1150 Intel® Xeon® E3, Core™ i3, Pentium® or Celeron® processor supported
- Four 240-pin 1600/1333 MHz dual-channel DDR3 DIMMs support up to 32 GB
- Supports dual independent display by VGA and iDP interfaces
- Supports PCIe Mini devices and mSATA via PCIe Mini socket
- Supports RAID function via SATA 6Gb/s
- Stiffener bars
- IEI jumper-less function
- Supports IPMI 2.0 via iRIS-2400 module

Packing List

1 x SPCIE-C2260-i2 single board computer
1 x Dual RS-232 cable
1 x USB 2.0 cable
2 x SATA cable
1 x QIG

Ordering Information

Part No.	Description
SPCIE-C2260-i2-R10	Full-size PICMG 1.3 CPU card supports LGA 1150 Intel® Xeon® E3, Core™ i3, Pentium® and Celeron® with Intel® C226, DDR3, VGA, iDP, Dual Intel® PCIe GbE, SATA 6Gb/s, mSATA, RS-232, PCIe Mini, HD Audio, iRIS-2400 and RoHS
iRIS-2400-R10	IPMI 2.0 adapter card with AST2400 BMC chip for DDR3 SO-DIMM socket interface
19800-000049-RS	LPT flat cable, 240mm, P=2.54
19800-000075-RS	PS/2 KB/MS cable with bracket, 220mm, P=2.0
19800-010500-200-RS	USB 3.1 Gen 1 (5Gb/s) cable with bracket, 450mm
32102-000100-200-RS	SATA power cable, MOLEX 5264-4P to SATA15P
32205-003800-300-RS	RS-422/485 cable, 200mm, P=2.0
AC-KIT-892HD-R10	7.1-channel HD Audio kit with Realtek ALC892 supports dual audio streams
CF-1150SB-R11	Special cooler kit for LGA 1150, high-performance compatible, 65W
CF-1150SC-R20	Special cooler kit for LGA1150, 1U chassis compatible, 65W
CF-1150SE-R11	Special cooler kit for LGA1150, high-performance compatible, 95W
CF-1150SF-R10	Special cooler kit for LGA1150, 1U chassis compatible, 54W
DP-DP-R10	DisplayPort to DisplayPort converter board (for IEI iDP connector)
DP-DVI-R10	DisplayPort to DVI-D converter board (for IEI iDP connector)
DP-HDMI-R10	DisplayPort to HDMI converter board (for IEI iDP connector)
DP-LVDS-R10	DisplayPort to LVDS converter board (for IEI iDP connector)
DP-VGA-R10	DisplayPort to VGA converter board (for IEI iDP connector)
TPM-IN01-R20	20-pin Infineon TPM module, software management tool, firmware v3.17

PICMG 1.3 Backplane

Selection Guide

PAC series wall-mount chassis

4U rack-mount chassis







Backplane		SPE-4S	SPE-6S	SPE-9S	SPXE-11S	SPXE-14S
Total	Slot	4	6	7	11	14
PCIe	x16					
	x8	2 (x16 connector)		1 (x16 connector)		1 (x16 connector)
	x4	1	5	3	6 (x16 connector)	
	x1					12 (x4 connector)
	PCI-X					
	PCI			3	4	
PSU Type		24+4-pin ATX	24+4-pin ATX	24+4-pin ATX	24+8-pin ATX	24+8-pin ATX
Chassis Option		PAC-106G PAC-1000G	PAC-106G PAC-1000G	PAC-125G	RACK-305G RACK-360G RACK-3000G	RACK-305G RACK-360G RACK-3000G

IEI Server Grade Backplane Solution

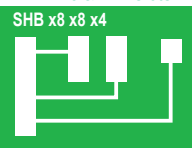
Server grade backplane accommodates PCIe x8 and multiple PCIe x4 add-on cards. It is specially designed for intensive data transfer applications such as server data storage and any application that requires more than one PCIe x4 or four PCIe x1 cards. Given the multiple PCIe x4 and x1 support, it provides a more cost effective solution for end-users by reducing the number of systems required.

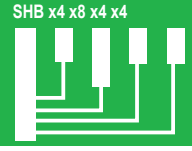
System Solution for options

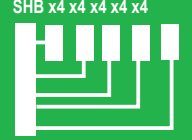
Backplane	Total Slot	PCIe						PSU Type	Chassis Option
		x16	x8	x4	x1	PCI-X	PCI		
SPE-4S	4	-	2 (x16 connector)	1	-	-	24+4-pin ATX	PAC-106G PAC-1000G	
SPE-6S	6	-	-	5	-	-	24+4-pin ATX	PAC-106G PAC-1000G	
SPE-9S	7	-	1 (x16 connector)	3	-	3	24+4-pin ATX	PAC-125G	
SPXE-11S	11	-	-	6 (x16 connector)	-	4	24+8-pin ATX	RACK-305G RACK-360G RACK-3000G	
SPXE-14S	14	-	1 (x16 connector)	-	12 (x4 connector)	-	24+8-pin ATX	RACK-305G RACK-360G RACK-3000G	

Server Grade Backplane	
Example	Corresponding Model
<p>EX1: 2 x8 & 1 x4 slots</p> <p>SHB x8 x8 x4</p> 	<p>SPE-4S</p> 
<p>EX2: 1 x8 & 3 x4 slots</p> <p>SHB x4 x8 x4 x4</p> 	<p>SPE-9S</p> 
<p>EX3: 5 x4 slots</p> <p>SHB x4 x4 x4 x4 x4</p> 	<p>SPE-6S</p> 

SPE-4S-R10

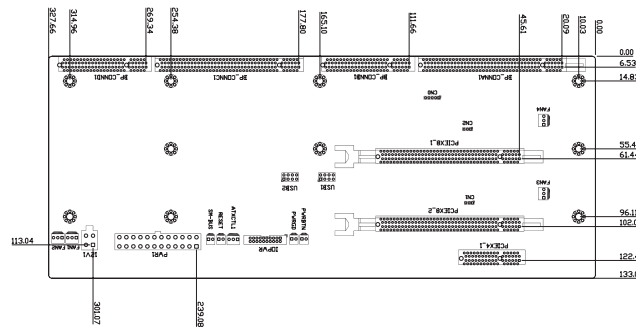
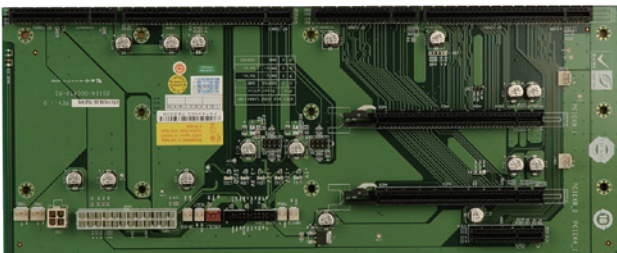

Ordering Information

SPE-4S-R10	4-slot PICMG 1.3 backplane with two PCIe x16 slots (x8 signal) and one PCIe x4 slot
PAC-106G	6-slot full-size compact chassis
PAC-1000G	6-slot full-size compact chassis



SPE-6S-R10

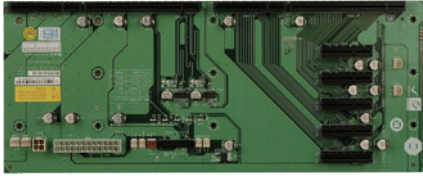

Ordering Information

SPE-6S-R10	6-slot PICMG 1.3 backplane with five PCIe x4 slots
PAC-106G	6-slot full-size compact chassis
PAC-1000G	6-slot full-size compact chassis

Note: PCIeX4_3 can not work with SPCIE-C2060, SPCIE-C2160, SPCIE-C22260, SPCIE-C236 & HPCIIE-C236.

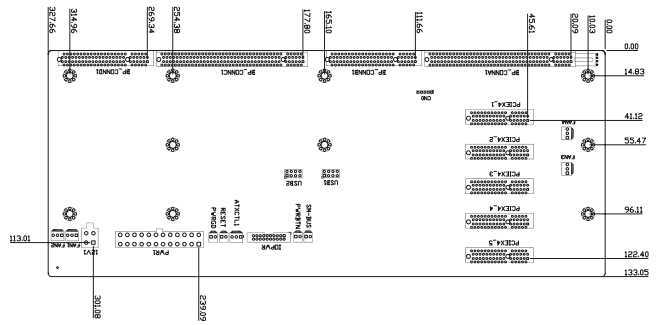

SPE-9S-R11

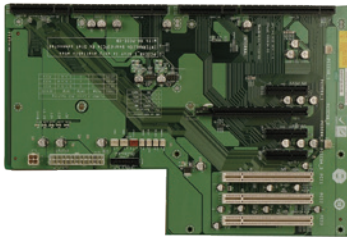

Ordering Information

SPE-9S-R11	7-slot PICMG 1.3 backplane with one PCIe x16 slot (x8 signal), three PCIe x4 slots and three PCI slots
PAC-125G	10-slot full-size compact chassis

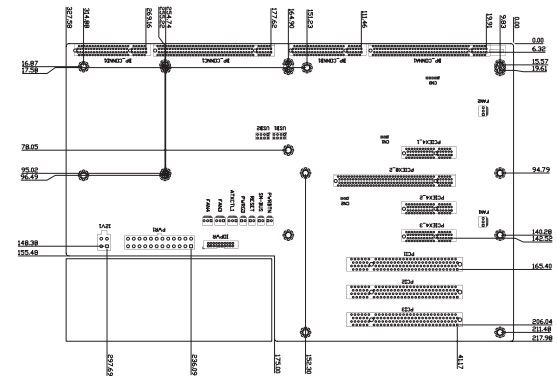

SPXE-11S-R10

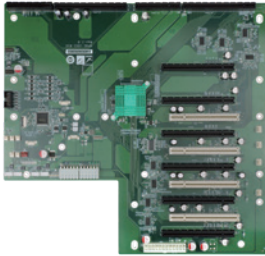

Ordering Information

SPXE-11S-R10	11-Slot PICMG 1.3 PCIe to PCIe Switch (PLX PEX8724) Backplane, 6 PCIe Gen 3.0 x4 w/ x16 slot, 4 PCI, RoHS
RACK-305G	4U 14-slot full-size rack-mount chassis
RACK-360G	4U 14-slot full-size rack-mount chassis
RACK-3000G	4U 14-slot full-size rack-mount chassis

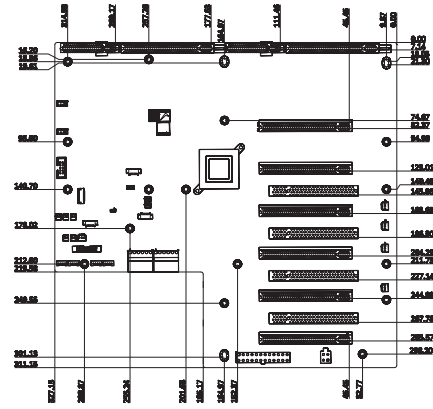

SPXE-14S-R20

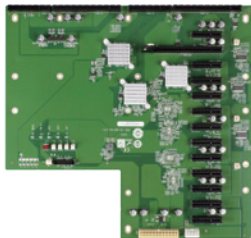

Ordering Information

SPXE-14S-R20	14-slot PICMG 1.3 backplane with one PCIe x16 slot (x8 signal) and twelve PCIe x4 slots (x1 signal)
RACK-305G	4U 14-slot full-size rack-mount chassis
RACK-360G	4U 14-slot full-size rack-mount chassis
RACK-3000G	4U 14-slot full-size rack-mount chassis

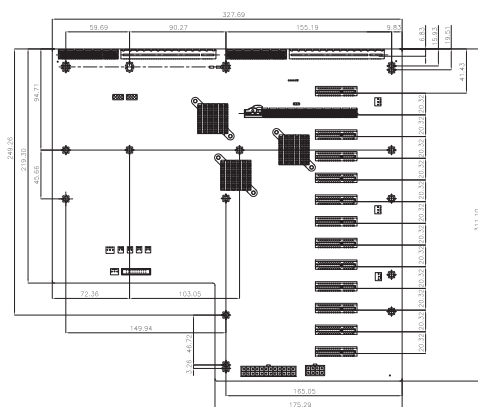

PCIE-Q370

Full-size PICMG 1.3 CPU Card supports LGA1151 Intel® Core™ i7/i5/i3/ Pentium®/ Celeron® CPU per Intel® Q370, DDR4, VGA, DP, Dual Intel® PCIe GbE, SATA 6Gb/s, USB 3.1 Gen 1 (5Gb/s), M.2, HD Audio, Intel® AMT and RoHS

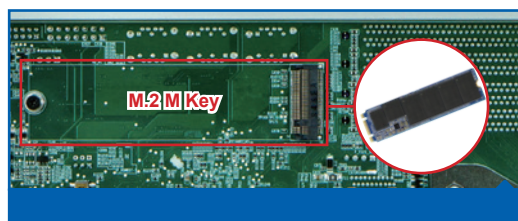
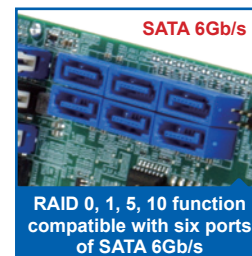
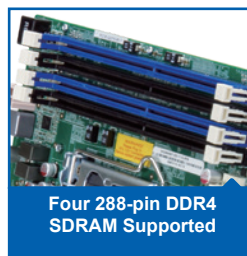
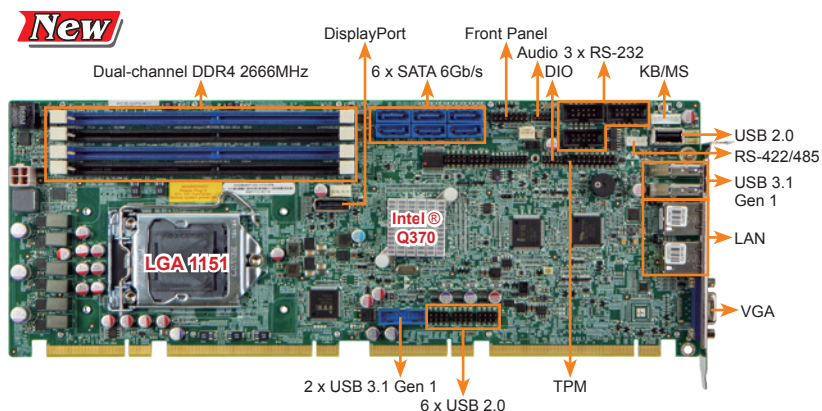

Specifications

- ◆ CPU
LGA1151 socket supports 8th generation Intel® Core® i7/i5/i3, Pentium® or Celeron® processor
- ◆ Chipset
Intel® Q370
- ◆ Memory
Four 288-pin 2666MHz dual-channel DDR4 SDRAM unbuffered DIMMs support up to 64GB
- ◆ BIOS
AMI UEFI BIOS
- ◆ Graphic Engine
Intel® HD Graphics Gen 9 Engines with Low power 16 execution unit, supports DX2015, OpenGL 5.X and OpenCL2.x, ES 2.0
- ◆ Display Output
Dual display supported
1 x VGA (up to 1920x1200@60 Hz)
1 x DP (up to 4096 x 2304@60Hz)
- ◆ Ethernet
LAN1: Intel® I219LM PHY
LAN2: Intel® I211-AT PCIe controller (Co-lay I210-AT)
- ◆ External I/O Interface
2 x USB 3.1 Gen 1 (5Gb/s) (Rear IO type A)
1 x USB 2.0 (Type A 180°)
- ◆ Internal I/O Interface
1 x KB/MS (1x6 pin)
1 x RS-422/485 (1x4 pin, P=2.0)
2 x USB 3.1 Gen 1 (5Gb/s) (2x10 pin)
3 x RS-232 (2x5 pin, P=2.54)
6 x SATA 6Gb/s (RAID 0/1/5/10 supported)
6 x USB 2.0 (2x4 pin, P=2.54)
- ◆ Audio
Support 7.1 channel HD audio by IEI AC-KIT-892HD kit
- ◆ Front Panel
1 x Front panel (Power LED, HDD LED, Speaker, Power Button, Reset Button)
- ◆ LAN LED
2 x LAN LED (1x2 pin)
- ◆ TPM
1 x TPM (2x10 pin)
- ◆ SMBus
1 x SMBus (1x4 pin)
- ◆ I²C
1 x I²C (1x4 pin)
- ◆ Expansion
1 x M.2 M key
1 x PCIe x16 & 4 x PCIe x1 signal via golden finger
4 x PCI signal via golden finger
- ◆ Watchdog Timer
Software programmable support 1~255 sec. system reset
- ◆ Digital I/O
8-bit digital I/O (2x5 pin)
- ◆ Fan Connector
1 x CPU smart fan (1x4 pin)
1 x System smart fan (1x4 pin)
- ◆ Power Supply
AT/ATX power supply
Support AT/ATX mode
ErP/EuP Compliant
- ◆ Power Consumption
5V@3.12A, 12V@6.85A, 3.3V@1.13A, 5VSB@0.15A
(4.0 GHz Intel® Core™ i7-8700K CPU with four 16 GB 2666 MHz DDR4 memory)
- ◆ Operating Temperature
-20°C ~ 60°C
- ◆ Operating Humidity
5% ~ 95%, non-condensing
- ◆ Dimension: 338 mm x 126 mm
- ◆ Weight: GW: 1000g / NW: 500g
- ◆ CE/FCC compliant



Features

- PICMG 1.3 full-size CPU card
- LGA1151 Intel® 8th Generation Core™ i7/i5/i3, Celeron® and Pentium® processor supported
- Dual-channel DDR4 2666MHz
- Support VGA/HDMI and DP display
- Intel® PCIe GbE with Intel® AMT 11.0 supported
- Support M.2 M key for storage (PCIe x4)
- Supports RAID 0, 1, 5, 10 function via SATA 6Gb/s

Packing List

1 x PCIE-Q370-R10 single board computer
1 x SATA cable
1 x Mini jumper pack
1 x QIG (Quick Installation Guide)

Ordering Information

Part No.	Description
PCIE-Q370-R11	Full-size PICMG 1.3 CPU Card supports LGA1151 Intel® Core™ i7/i5/i3/Pentium®/Celeron® CPU per Intel® Q370, DDR4, Dual Intel® PCIe GbE, USB 3.1 Gen 1 (5Gb/s), SATA 6Gb/s, VGA, DP, M.2, HD Audio, iAMT and RoHS
19800-000075-RS	PS/2 KB/MS cable with bracket, 220mm, P=2.0
32102-000100-200-RS	SATA power cable, MOLEX 5264-4P to SATA15P
AC-KIT-892HD-R10	7.1 channel HD Audio kit with Realtek ALC892 support dual audio streams
CF-1150SA-R10	Special cooler kit for LGA1150, High-performance compatible, 95W
CF-1150SB-R11	Special cooler kit for LGA1150, High-performance compatible, 65W
CF-1150SC-R20	Special cooler kit for LGA1150, 1U chassis compatible, 65W
CF-1150SE-R11	Special cooler kit for LGA1150, high-performance compatible, 95W
CF-1150SF-R10	Special cooler kit for LGA1150, 1U chassis compatible, 54W
SAIDE-KIT01-R10	SATA to IDE/CF Converter board

PCIE-Q170

Full-size PICMG 1.3 CPU Card supports LGA1151 Intel® Core™ i7/i5/i3/Pentium®/ Celeron® CPU per Intel® Q170, DDR4, VGA/iDP, Dual Intel® PCIe GbE, PCIe Mini, mSATA, USB 3.1 Gen 1 (5Gb/s), SATA 6Gb/s, HD Audio, Intel® AMT, iRIS-2400 and RoHS

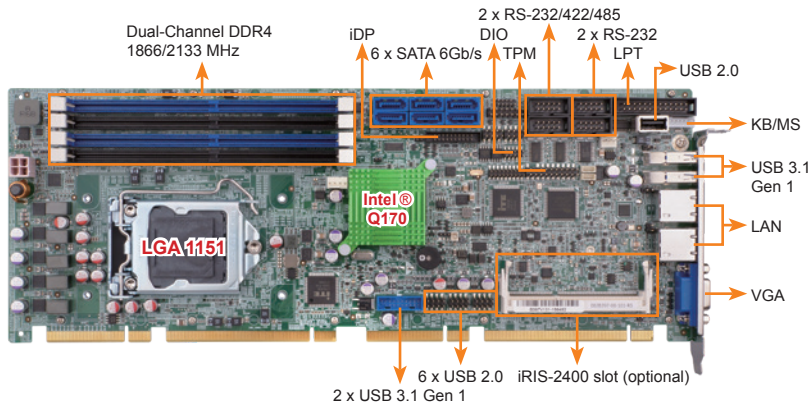

Four 288-pin DDR4 SDRAM Supported

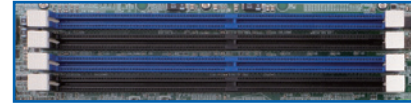

RAID 0, 1, 5, 10 function compatible with six ports of SATA 6Gb/s

Specifications

- ◆ CPU
 - LGA 1151 socket supports Intel® 6th/7th generation Core™ i7/i5/i3, Pentium® or Celeron® processor
- ◆ Chipset
 - Intel® Q170
- ◆ Memory
 - Four 288-pin 1866/2133 MHz dual-channel unbuffered DDR4 DIMMs support up to 64GB
- ◆ BIOS
 - UEFI BIOS
- ◆ Graphic Engine
 - Intel® HD Graphics Gen 9 supports DX11/12, OpenCL 2.x and OpenGL 4.3/4.4 Decode/Encode for HEVC, VP8, VP9, VDENC
- ◆ Display Output
 - Dual independent display
 - 1 x VGA (up to 1920x1200@60 Hz)
 - 1 x iDP interface for HDMI, LVDS, VGA, DVI and DisplayPort (up to 3840x2160@60 Hz)
- ◆ Ethernet
 - LAN1: Intel® I219LM Clarkville-V with Intel® AMT 11.0 supported
 - LAN2: Intel® I210 PCIe controller
- ◆ External I/O Interface
 - 2 x USB 3.1 Gen 1 (5Gb/s)
- ◆ Internal I/O Interface
 - 1 x KB/MS (1x6 pin)
 - 1 x LPT (2x13 pin)
 - 1 x mSATA (SATA & USB signal)
 - 1 x USB 2.0 (180° Type-A)
 - 2 x RS-232 (2x5pin, P=2.54)
- ◆ Front Panel
 - 1 x Front Panel (1x10 pin, power LED, HDD LED, speaker, power button, reset button)
- ◆ LAN LED
 - 2 x LAN LED (1x2 pin)
- ◆ Audio
 - Support 7.1 channel HD audio by IECI AC-KIT-892HD kit
- ◆ TPM
 - 1 x TPM (2x10 pin)
- ◆ SMBus
 - 1 x SMBus (1x4 pin)
- ◆ I²C
 - 1 x I²C (1x4 pin)
- ◆ iRIS Remote Management Module
 - 1 x iRIS-2400 slot (optional)
- ◆ Expansion
 - 16-lane PCIe link from CPU via golden finger:**
Supports one PCIe x16, or two PCIe x8, or one PCIe x8 + two PCIe x4 on the backplane (configured via BIOS)
 - 4-lane PCIe link from PCH via golden finger:**
Supports four PCIe x1 slots or one PCIe x4 slot on the backplane (configured via BIOS switch)
 - 1 x Full/Half-size PCIe Mini card slot
 - Four PCI signal via golden finger**
- ◆ Watchdog Timer
 - Software programmable, supports 1~255 sec. system reset
- ◆ Digital I/O
 - 8-bit digital I/O (2x5 pin)
- ◆ Fan Connector
 - 1 x CPU smart fan (1x4 pin)
 - 1 x System smart fan (1x3 pin)
- ◆ Power Supply
 - 5V/12V, AT/ATX support
- ◆ Power Consumption
 - 5V@3.12A, 12V@6.85A, 3.3V@1.13A, 5VSB@0.15A (Intel® Core™ i7-6700K 4.0GHz CPU with 64GB (16GB x 4) 2133 MHz DDR4 memory)
- ◆ Operating Temperature
 - 20°C ~ 60°C
- ◆ Operating Humidity
 - 5% ~ 95%, non-condensing
- ◆ Dimensions: 338 mm x 126 mm
- ◆ Weight: GW: 1000g / NW: 420g
- ◆ CE/FCC compliant



Features

- PICMG 1.3 full-size CPU Card
- LGA 1151 Intel® 6th/7th generation Core™ i7/i5/i3, Pentium® or Celeron® processor supported
- Four 288-pin 1866/2133MHz dual-channel DDR4 UDIMMs support up to 64GB
- Supports dual independent display by VGA & internal DP pin header
- Supports PCIe Mini device & mSATA via PCIe Mini card slot
- Intel® PCIe GbE with Intel® AMT 11.0 supported
- Supports RAID 0, 1, 5, 10 function via SATA 6Gb/s
- TPM 1.2 & 2.0 hardware security function supported by TPM module

Packing List

1 x PCIE-Q170 single board computer	1 x Mini jumper pack
1 x SATA cable	1 x QIG

Ordering Information

Part No.	Description
PCIE-Q170-R10	Full-size PICMG 1.3 CPU Card supports LGA1151 Intel® Core™ i7/i5/i3/Pentium®/Celeron® CPU per Intel® Q170, DDR4, VGA/iDP, Dual Intel® PCIe GbE, PCIe Mini, USB 3.1 Gen 1 (5Gb/s), SATA 6Gb/s, mSATA, HD Audio, iAMT and RoHS
PCIE-Q170-i2-R10**	Full-size PICMG 1.3 CPU Card supports LGA1151 Intel® Core™ i7/i5/i3/Pentium®/Celeron® CPU per Intel® Q170, DDR4, VGA/iDP, Dual Intel® PCIe GbE, PCIe Mini, USB 3.1 Gen 1 (5Gb/s), SATA 6Gb/s, mSATA, HD Audio, iAMT, iRIS-2400 and RoHS
19800-000049-RS	LPT flat cable, 240mm, P=2.54
19800-000075-RS	PS/2 KB/MS cable with bracket, 220mm, P=2.0
32102-000100-200-RS	SATA power cable, MOLEX 5264-4P to SATA15P
AC-KIT-892HD-R10	7.1 channel HD Audio kit with Realtek ALC892 support dual audio streams
CF-1150SA-R10	Special cooler kit for LGA1150, High-performance compatible, 95W
CF-1150SB-R11	Special cooler kit for LGA1150, High-performance compatible, 65W
CF-1150SC-R20	Special cooler kit for LGA1150, 1U chassis compatible, 65W
CF-1150SE-R11	Special cooler kit for LGA1150, high-performance compatible, 95W
CF-1150SF-R10	Special cooler kit for LGA1150, 1U chassis compatible, 54W
DP-DP-R10	DisplayPort to DisplayPort converter board (for IECI iDP connector)
DP-DVI-R10	DisplayPort to DVI-D converter board (for IECI iDP connector)
DP-HDMI-R10	DisplayPort to HDMI converter board (for IECI iDP connector)
DP-LVDS-R10	DisplayPort to LVDS converter board (for IECI iDP connector)
DP-VGA-R10	DisplayPort to VGA converter board (for IECI iDP connector)
SAIDE-KIT01-R10	SATA to IDE/CF Converter board

**By order production, MOQ: 100

PCIE-Q670-R20

Full-size PICMG 1.3 CPU Card supports LGA 1155 Intel® Core™ i7/i5/i3, Pentium® or Celeron® CPU with Intel® Q67, DDR3, VGA, DVI-D, Dual Intel® PCIe GbE, SATA 6Gb/s, PCIe Mini, HD Audio and RoHS

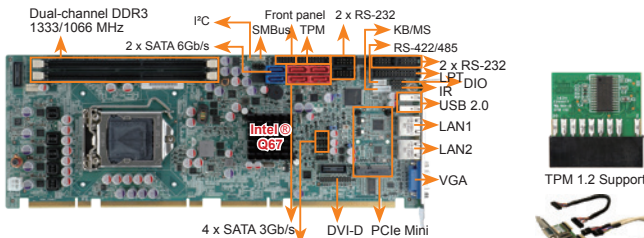

Features

- PICMG 1.3 full-size graphics grade solution
- LGA 1155 Intel® Core™ i7/i5/i3, Pentium® or Celeron® processors supported
- Up to 16 GB 1333 MHz dual-channel DDR3 SDRAM
- Supports dual independent display by VGA and DVI-D (DVI model)
- Supports RAID function via SATA 6Gb/s and SATA 3Gb/s
- TPM v1.2 hardware security provided by the TPM module
- IEI One Key Recovery solution allows you to create rapid OS backup and recovery

Specifications

- ◆ CPU: LGA 1155 socket supports Intel® Core™ i7/i5/i3, Pentium® or Celeron® processor
- ◆ Chipset: Intel® Q67
- ◆ Memory: Two 240-pin 1333/1066 MHz dual-channel unbuffered DDR3 & DDR3L SDRAM DIMMs support up to 16 GB
- ◆ BIOS: UEFI BIOS
- ◆ Graphics Engine: Intel® HD Graphics Gen 6 supports DX10.1 and OpenGL 3.0 Full MPEG2, VC1, AVC Decode
- ◆ Display Output
 - ◆ 1 x VGA (up to 2048x1536@75Hz)
 - ◆ 1 x DVI-D (via header to IO-KIT-001-R20 DVI-D/USB module) (optional)
- ◆ Ethernet
 - ◆ LAN1: Intel® 82583V PCIe controller
 - ◆ LAN2: Intel® 82579 PHY with Intel® AMT 7.0 support
- ◆ External I/O Interface: 2 x USB 2.0
- ◆ Internal I/O Interface
 - ◆ 1 x KB/MS (1x6 pin) 1 x LPT (2x13 pin)
 - ◆ 1 x RS-422/485 (1x4 pin, P=2.0)
 - ◆ 2 x SATA 6Gb/s (RAID 0/1/5/10 supported)
 - ◆ 4 x RS-232 (2x5pin, P=2.54)
 - ◆ 4 x SATA 3Gb/s (RAID 0/1/5/10 supported)
 - ◆ 4 x USB 2.0 (Golden finger)
 - ◆ 6 x USB 2.0 (2x4 pin, P=2.54)
- ◆ Front Panel: 1 x Front panel connector (2x7 pin, power LED, HDD LED, speaker, power button, reset button)
- ◆ Audio: Supports 7.1-channel HD Audio by IEI AC-KIT-892HD-R10 kit
- ◆ TPM: 1 x TPM (2x10 pin)
- ◆ SMBus: 1 x SMBus (1x4 pin)
- ◆ Infrared Interface: 1 x Infrared Interface (1x5 pin)
- ◆ Expansion
 - ◆ PCIe signal and PCI signal via golden finger
 - ◆ 1 x Full/Half-size PCIe Mini card slot
- ◆ Watchdog Timer: Software programmable supports 1~255 sec. system reset
- ◆ Digital I/O: 8-bit digital I/O (2x5 pin)
- ◆ Fan Connector: 1 x Smart fan (1x4 pin)
- ◆ Power Supply: AT/ATX power supply supported
- ◆ Power Consumption
 - ◆ 5V@3.45A, 12V@0.32A, Vcore_12V@5.24A, 3.3V@1.69A, 5VSB@0.17A (3.4GHz Intel® Core™ i7-2600K with two 2 GB 1333 MHz DDR3 memory)
 - ◆ Operating Temperature: -10°C ~ 60°C
 - ◆ Storage Temperature: -20°C ~ 70°C
 - ◆ Operating Humidity: 5% ~ 95%, non-condensing
 - ◆ Dimensions: 338 mm x 126 mm
 - ◆ Weight: GW: 1200g / NW: 420g
 - ◆ CE/FCC compliant

Packing List

1 x PCIE-Q670 single board computer	4 x SATA cable
1 x Dual RS-232 cable	1 x Mini jumper pack
1 x USB cable	1 x QIG

Ordering Information

Part No.	Description
PCIE-Q670-R20	Full-size PICMG 1.3 CPU card supports LGA 1155 32nm Intel® Core™ i7/i5/i3, Pentium® or Celeron® CPU with Intel® Q67, DDR3, VGA, dual Intel® PCIe GbE, SATA 6Gb/s, PCIe Mini, HD Audio and RoHS
PCIE-Q670-DVI-R20	Full-size PICMG 1.3 CPU card supports LGA 1155 32nm Intel® Core™ i7/i5/i3, Pentium® or Celeron® CPU with Intel® Q67, DDR3, DVI-D, dual Intel® PCIe GbE, SATA 6Gb/s, PCIe Mini, HD Audio and RoHS
19800-000049-RS	LPT flat cable, 240mm, P=2.54
19800-000075-RS	PS/2 KB/MS cable with bracket, 220mm, P=2.0
32102-000100-200-RS	SATA power cable, MOLEX 5264-4P to SATA15P
32205-003800-300-RS	RS-422/485 cable, 200mm, P=2.0
AC-KIT-892HD-R10	7.1-channel HD Audio kit with Realtek ALC892 supports dual audio streams
CF-115XA-R10	High-performance LGA 1155/LGA 1156 cooler kit, 1U chassis compatible, 73W
CF-1156C-R20	LGA 1155/LGA 1156 cooler kit, 1U chassis compatible, 45W
CF-1156D-R20	LGA 1155/LGA 1156 cooler kit, 1U chassis compatible, 65W
CF-115XE-R10	High-performance LGA 1155/LGA 1156 cooler kit, 95W
CPU-DT-C-G440	Intel® Celeron® G440 processor, LGA 1155, single core 1.6GHz, 1M cache, 35W, compatible with CF-1156C-R20 CPU cooler
CPU-DT-i3-2120T	Intel® Core™ i3-2120T processor, LGA 1155, dual core 2.6GHz, 3M cache, 35W, compatible with CF-1156C-R20 CPU cooler
CPU-DT-i5-2390T	Intel® Core™ i5-2390T processor, LGA 1155, dual core 2.7GHz, 3M cache, 35W, AMT, compatible with CF-1156C-R20 CPU cooler
CPU-DT-i5-2500T	Intel® Core™ i5-2500T processor, LGA 1155, quad core 2.3GHz, 6M cache, 45W, compatible with CF-1156C-R20 CPU cooler
CPU-DT-P-G630T	Intel® Pentium® G630T processor, LGA 1155, dual core 2.3GHz, 3M cache, 35W, compatible with CF-1156C-R20 CPU cooler
SAIDE-KIT01-R10	SATA to IDE/CF converter board

PCIE-H610

Full-size PICMG 1.3 CPU Card supports 32nm LGA 1155 Intel® Core™ i7/i5/i3, Pentium® or Celeron® CPU with Intel® H61, DDR3, VGA, USB 2.0, SATA 3Gb/s, Dual Realtek PCIe GbE, HD Audio and RoHS

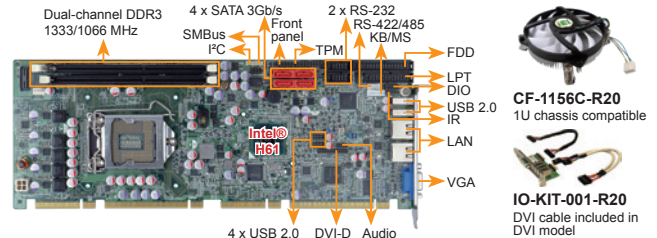

Features

- Full-size PICMG 1.3 graphics grade solution
- LGA 1155 Intel® Core™ i7/i5/i3, Pentium® or Celeron® processor supported
- Dual-channel 1333/1066 MHz DDR3/DDR3L SDRAM supported up to 16 GB
- Intel® HD graphics technology integrates high-performance graphics and media processing
- TPM v1.2 hardware security function supported by TPM module
- IEI One Key Recovery solution allows you to create rapid OS backup and recovery

Specifications

- ◆ CPU: LGA 1155 socket supports Intel® Core™ i7/i5/i3, Pentium® or Celeron® processor
- ◆ Chipset: Intel® H61
- ◆ Memory: Two 240-pin 1333/1066 MHz dual-channel unbuffered DDR3 & DDR3L SDRAM DIMMs support up to 16 GB
- ◆ BIOS: UEFI BIOS
- ◆ Graphics Engine
 - ◆ Intel® HD Graphics Gen 6 supports DX10.1 and OpenGL 3.0
 - ◆ Full MPEG2, VC1, AVC Decode
- ◆ Display Output
 - ◆ 1 x VGA (up to 2048x1536@75Hz)
 - ◆ 1 x DVI-D (up to 1920x1200@60Hz) (via header to IO-KIT-001-R20 DVI-D/USB module) (optional)
- ◆ Ethernet
 - ◆ LAN1: Realtek RTL8111E PCIe GbE controller with ASF 2.0 support
 - ◆ LAN2: Realtek RTL8111E PCIe GbE controller
- ◆ TPM: 1 x TPM (2x10 pin)
- ◆ SMBus: 1 x SMBus (1x4 pin)
- ◆ PC: 1 x PC (1x4 pin)
- ◆ Infrared Interface: 1 x Infrared Interface (1x5 pin)
- ◆ Digital I/O: 8-bit digital I/O (2x5 pin)
- ◆ External I/O Interface: 2 x USB 2.0
- ◆ Audio: Supports by IEI AC-KIT-892HD-R10 audio kit
- ◆ Internal I/O Interface
 - ◆ 1 x FDD (2x17 pin) 1 x KB/MS (1x6 pin)
 - ◆ 1 x LPT (2x13 pin) 4 x SATA 3Gb/s
 - ◆ 1 x RS-422/485 (1x4 pin, P=2.0)
 - ◆ 2 x RS-232 (2x5pin, P=2.54)
 - ◆ 4 x USB 2.0 (2x4 pin, P=2.54)
 - ◆ 4 x USB 2.0 (Golden finger)
- ◆ Front Panel
 - ◆ 1 x Front panel (2x7 pin, power LED, HDD LED, speaker, power button, reset button)
- ◆ Expansion: PCIe signal and PCI signal via golden finger
- ◆ Watchdog Timer: Software programmable supports 1~255 sec. system reset
- ◆ Fan Connector: 1 x Smart fan (1x4 pin)
- ◆ Power Supply: 5V/12V, AT/ATX support
- ◆ Power Consumption
 - ◆ 5V@4.41A, 12V@0.21A, Vcore_12V@7.72A, 3.3V@1.71A, 5VSB@0.16A (3.4GHz Intel® Core™ i7-2600K with two 2 GB 1333 MHz DDR3 memory)
 - ◆ Operating Temperature: -10°C ~ 60°C
 - ◆ Storage Temperature: -20°C ~ 70°C
 - ◆ Operating Humidity: 5% ~ 95%, non-condensing
 - ◆ Dimensions: 338 mm x 126 mm
 - ◆ Weight: GW: 1200g / NW: 420g
 - ◆ CE/FCC compliant

Packing List

1 x PCIE-H610 single board computer	4 x SATA cable
1 x Dual RS-232 cable	1 x Mini jumper pack
1 x USB cable	1 x QIG

Ordering Information

Part No.	Description
PCIE-H610-R10	Full-size PICMG 1.3 CPU card supports 32nm LGA 1155 Intel® Core™ i7/i5/i3 CPU with Intel® H61, DDR3, VGA, dual Realtek PCIe GbE, USB 2.0, SATA 3Gb/s, HD Audio and RoHS
PCIE-H610-DVI-R10	Full-size PICMG 1.3 CPU card supports 32nm LGA 1155 Intel® Core™ i7/i5/i3 CPU with Intel® H61, DDR3, VGA, DVI-D, dual Realtek PCIe GbE, USB 2.0, SATA 3Gb/s, HD Audio and RoHS
19800-000049-RS	LPT flat cable, 240mm, P=2.54
19800-000075-RS	PS/2 KB/MS cable with bracket, 220mm, P=2.0
32102-000100-200-RS	SATA power cable, MOLEX 5264-4P to SATA15P
32200-000017-RS	FDD Cable, 520mm, P=2.54
32205-003800-300-RS	RS-422/485 cable, 200mm, P=2.0
AC-KIT-892HD-R10	7.1-channel HD Audio kit with Realtek ALC892 supports dual audio streams
CF-115XA-R10	High performance LGA 1155/LGA 1156 cooler kit, 1U chassis compatible, 73W
CF-1156C-R20	LGA 1155/LGA 1156 cooler kit, 1U chassis compatible, 45W
CF-1156D-R20	LGA 1155/LGA 1156 cooler kit, 1U chassis compatible, 65W
CF-115XE-R10	High performance LGA 1155/LGA 1156 cooler kit, 95W
CPU-DT-C-G440	Intel® Celeron® G440 processor, LGA 1155, single core 1.6GHz, 1M cache, 35W, compatible with CF-1156C-R20 CPU cooler
CPU-DT-i3-2120T	Intel® Core™ i3-2120T processor, LGA 1155, dual core 2.6GHz, 3M cache, 35W, compatible with CF-1156C-R20 CPU cooler
CPU-DT-i5-2390T	Intel® Core™ i5-2390T processor, LGA 1155, dual core 2.7GHz, 3M cache, 35W, AMT, compatible with CF-1156C-R20 CPU cooler
CPU-DT-i5-2500T	Intel® Core™ i5-2500T processor, LGA 1155, quad core 2.3GHz, 6M cache, 45W, compatible with CF-1156C-R20 CPU cooler
CPU-DT-P-G630T	Intel® Pentium® G630T processor, LGA 1155, dual core 2.3GHz, 3M cache, 35W, compatible with CF-1156C-R20 CPU cooler
SAIDE-KIT01-R10	SATA to IDE/CF converter board
TPM-IN01-R20	20-pin Infineon TPM module, software management tool, firmware v3.17

PICMG 1.3 Passive Backplane

Selection Guide

PAC series wall-mount chassis

4U/5U rack-mount chassis

1U/2U rack-mount chassis

PICMG 1.3 (PCIe+PCI)	Model	PE-2SD1	PE-2SD2	PE-4S	PE-4S2	PE-6S	PE-6S2	PE-6S	PE-6S2	PE-6SD	PE-6SD3
Total Slot		2	2	4	4	5	5	6	6	5	5
Expansion Slots	PCIe Slots	x16 *	1	1	1	1	1	1	1	1	1
		x4			1		1		1		1
		x1						3	2		3
	PCI-X Slots										
PCI Slots		1	1	2	2	2	2	3		2	
USB Connectors by Pin Header		4	4	4	4	4	4	4	4	4	4
PSU Type		24+4-pin ATX	24+4-pin ATX	24+4-pin ATX	24+4-pin ATX	24+4-pin ATX	24+4-pin ATX	24+4-pin ATX	24+4-pin ATX	24+4-pin ATX	24+4-pin ATX
Chassis		RACK-1150-PE	RACK-1150-PE	N/A	N/A	RACK-500G	RACK-500G	RACK-305G RACK-360G RACK-3000G PAC-1700G PAC-125	PAC-106G PAC-1000G	N/A	N/A
Note		1U Type	1U Type							2U Type	2U Type

PICMG 1.3 (PCIe+PCI)	Model	PE-7S	PE-7S2	PE-8S	PE-9S	PE-10S	PE-10S2	PE-13SD	PXE-9S2	PXE-12S	PXE-13S	PXE-19S2
Total Slot		7	7	8	9	10	10	13	9	12	13	19
Expansion Slots	PCIe Slots	x16 *	1	1	1	1	1	1/1	1	1	1	1
		x4							3			
		x1	2	4	3	4	4	4	0/4			3
	PCI-X Slots								0	4		
PCI Slots		3	1	3	3	4	4	2/2	4	4	8	16
USB Connectors by Pin Header		4	4	4	4	4	4	8	4	4	4	4
PSU Type		24+4-pin ATX	24+4-pin ATX	24+4-pin ATX	24+4-pin ATX	24+4-pin ATX	24+4-pin ATX	Dual 24+4-pin ATX	24+4-pin ATX	24+4-pin ATX	24+4-pin ATX	24+4-pin ATX
Chassis		PAC-1700G	PAC-1700G	PAC-125G	N/A	RACK-305G RACK-360G RACK-3000G	RACK-3000G RACK-305G RACK-360G	RACK-3000G RACK-305G RACK-360G	RACK-3000G RACK-305G RACK-360G	RACK-3000G RACK-305G RACK-360G	RACK-3000G RACK-305G RACK-360G	N/A
Note								Dual System Backplane	PCIe to PCIe Switch Backplane	PCIe to PCI-X Bridge Backplane	PCIe to PCI Bridge Backplane	

*When using a PCIe x16 add-on card, the length of the card must not exceed 167mm or 6.57 inches.

IEI Graphics Grade Backplane Solution

The graphics grade backplane solution targets the applications which concern system speed and performance. It has higher performance over cost ratio than the previous PICMG 1.0 solution.

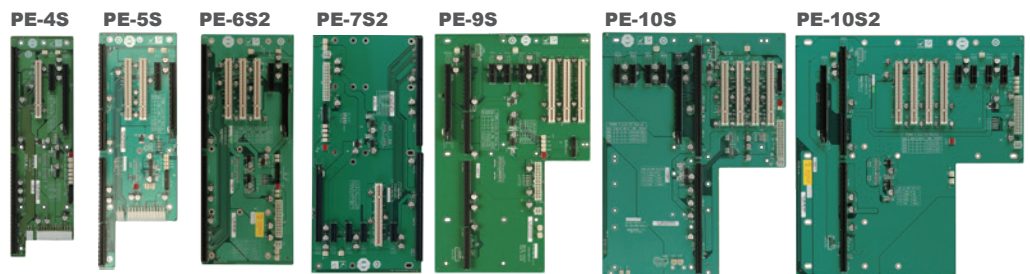
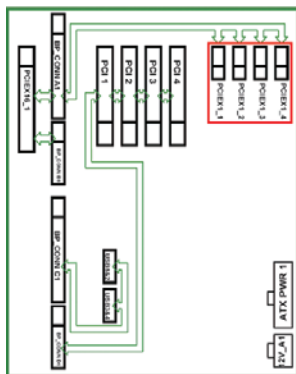

- Twenty PCIe lanes in total
- One PCIe x16 slot
- Up to four PCIe x1 or one PCIe x4 slot
- Up to four local PCI slots (w/o bridge)

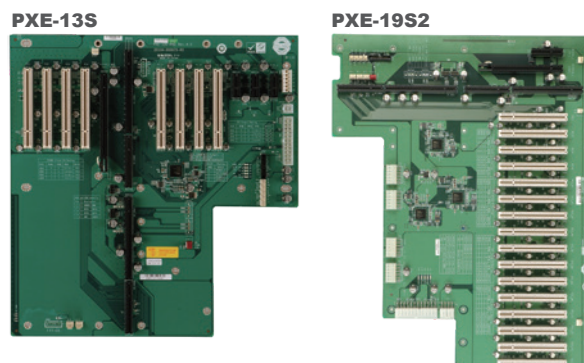
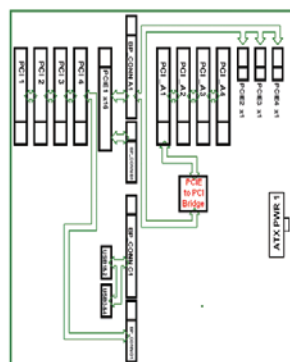

- Twenty PCIe lanes in total
- One PCIe x16 slot
- Up to four PCIe x1 slots
- PCI slots expandable via PCIe to PCI bridge

PE-2SD1-R10

For 1U system!

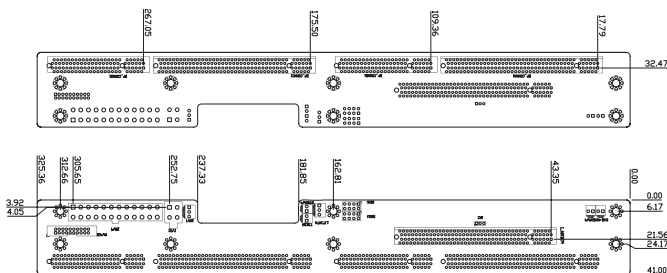
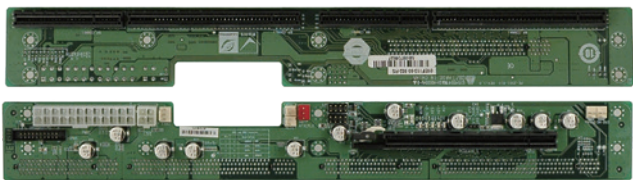

Ordering Information

PE-2SD1-R10 2-slot backplane with one PCIe slot
 RACK-1150G-PE 1U full-size rack-mount chassis

PE-4S-R40

Mounting holes compatible with PCI-4S

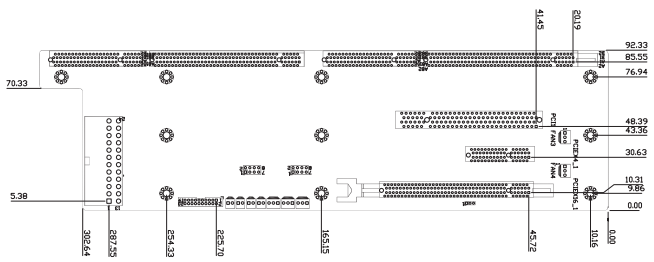
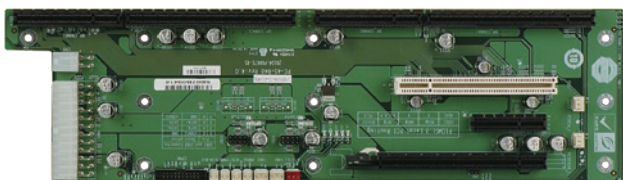

Ordering Information

PE-4S-R40 4-slot backplane with one PCIe x16 slot, one PCIe x4 slot and one PCI slot

PE-5S-R40

Mounting holes compatible with PCI-5S

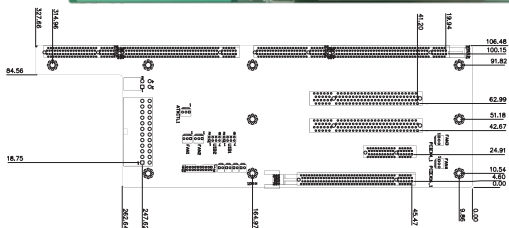
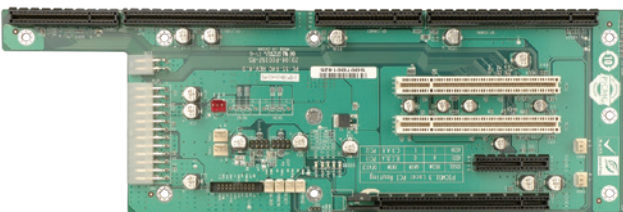

Ordering Information

PE-5S-R40 5-slot backplane with one PCIe x16 slot, one PCIe x4 slot and two PCI slots
 RACK-500G 5U 5-slot full-size rack-mount chassis

PE-2SD2-R10

For 1U system!

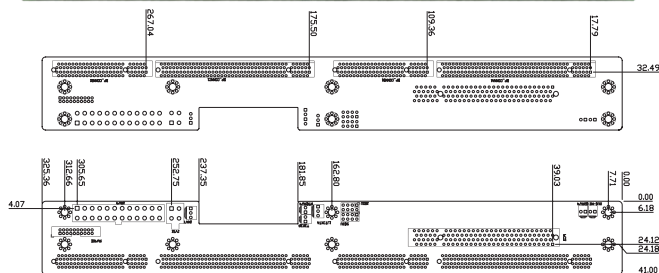
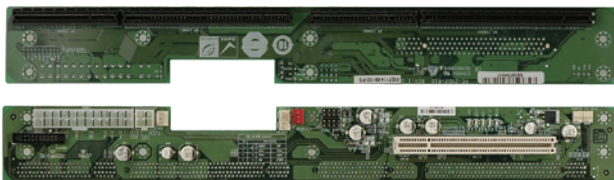

Ordering Information

PE-2SD2-R10 2-slot backplane with one PCI slot
 RACK-1150G-PE 1U full-size rack-mount chassis

PE-4S2-R40

Mounting holes compatible with PCI-4S

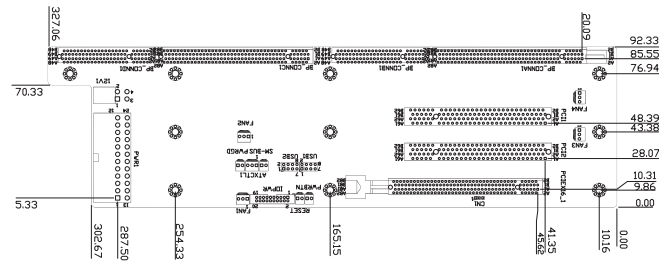
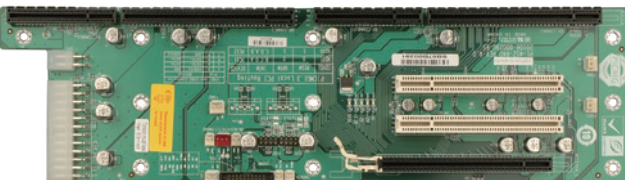

Ordering Information

PE-4S2-R40 4-slot backplane with one PCIe x16 slot and two PCI slots

PE-5S2-R40

Mounting holes compatible with PCI-5S

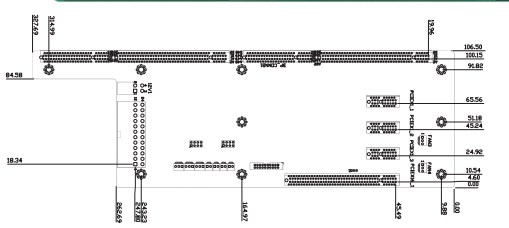
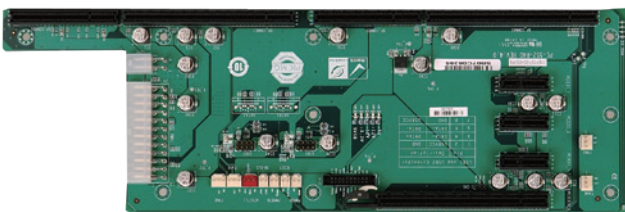

Ordering Information

PE-5S2-R40 5-slot backplane with one PCIe x16 slot and three PCIe x1 slots
 RACK-500G 5U 5-slot full-size rack-mount chassis

PE-6S-R41

Mounting holes compatible with PCI-7S

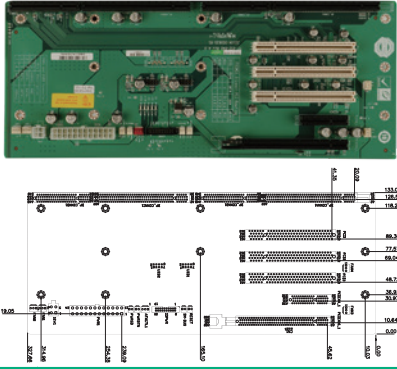

Ordering Information

PE-6S-R41	6-slot backplane with one PCIe x16 slot, two PCIe x1 slots and two PCI slots
RACK-305G	4U 14-slot full-size rack-mount chassis
RACK-360G	4U 14-slot full-size rack-mount chassis
RACK-3000G	4U 14-slot full-size rack-mount chassis
PAC-1700G	7-slot full-size compact chassis
PAC-125G	10-slot full-size compact chassis

PE-6S2-R40

Mounting holes compatible with PCI-6S

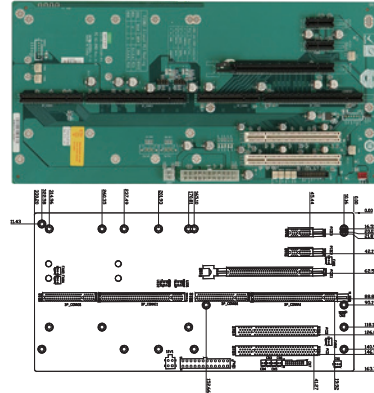

Ordering Information

PE-6S2-R40	6-slot backplane with one PCIe x16 slot, one PCIe x4 slot and three PCI slots
PAC-106G *	6-slot full-size compact chassis
PAC-1000G	6-slot full-size compact chassis

* When using a PCIe x16 add-on card, the length of the card must not exceed 167mm or 6.57 inches.

PE-6SD-R40

Mounting holes compatible with PCI-6SD
2U Type

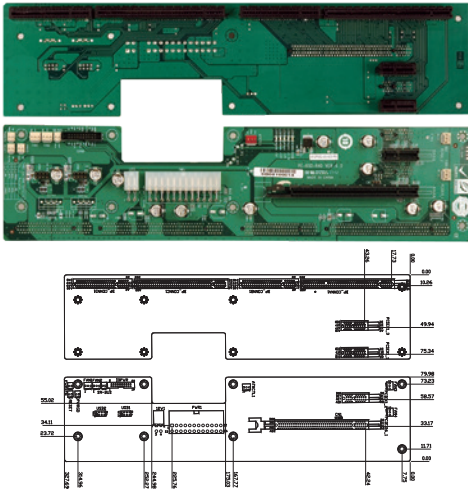

Ordering Information

PE-6SD-R40	5-slot backplane with one PCIe x16 slot and three PCIe x1 slots
------------	---

PE-6SD3-R40

Mounting holes compatible with PCI-6SD

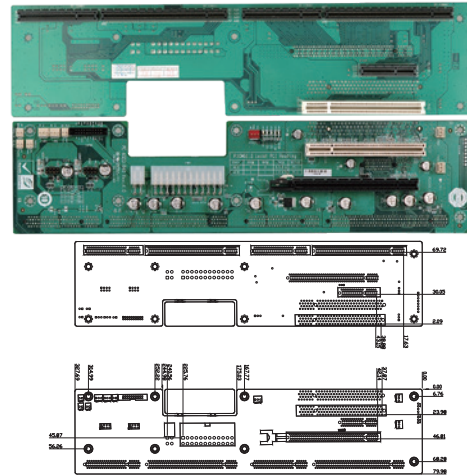

Ordering Information

PE-6SD3-R40	5-slot backplane with one PCIe x16 slot, one PCIe x4 slot and two PCI slots
-------------	---

PE-7S-R40

Mounting holes compatible with PCI-7S

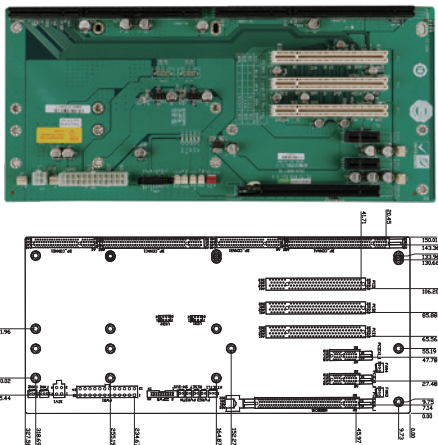

Ordering Information

PE-7S-R40	7-slot backplane with one PCIe x16 slot, two PCIe x1 slots and three PCI slots
PAC-1700G	7-slot full-size compact chassis

PE-7S2-R40

Mounting holes compatible with PCI-7S

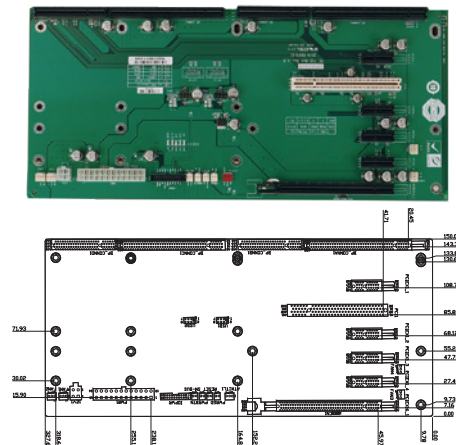

Ordering Information

PE-7S2-R40	7-slot backplane with one PCIe x16 slot, four PCIe x1 slots and one PCI slot
PAC-1700G	7-slot full-size compact chassis

PE-8S-R40

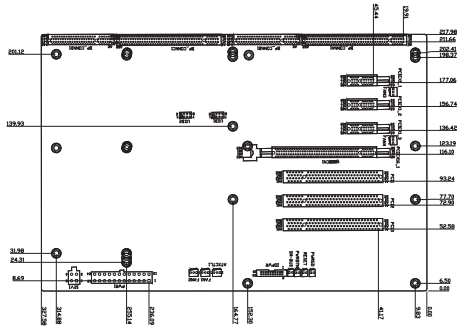
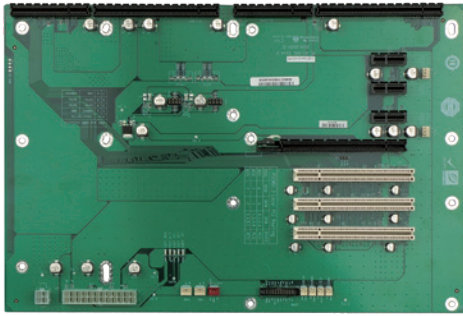

Ordering Information

PE-8S-R40	8-slot backplane with one PCIe x16 slot, three PCIe x1 slots and three PCI slots
PAC-125G	10-slot full-size compact chassis

PE-9S-R40

Mounting holes compatible with PCI-10S2

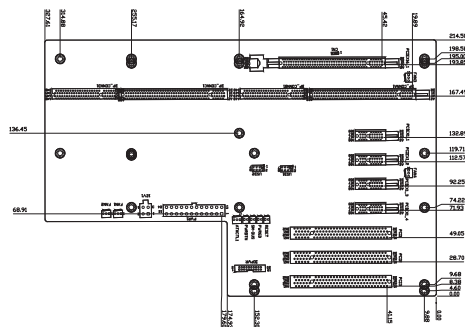
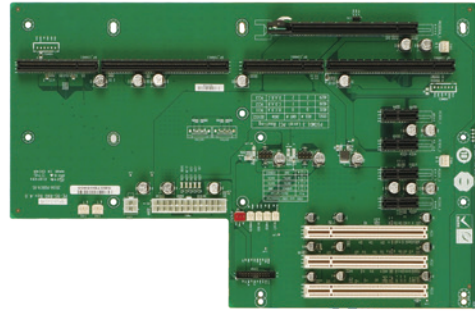

Ordering Information

PE-9S-R40	9-slot backplane with one PCIe x16 slot, four PCIe x1 slots and three PCI slots
-----------	---

PE-10S-R40

Mounting holes compatible with PCI-14S

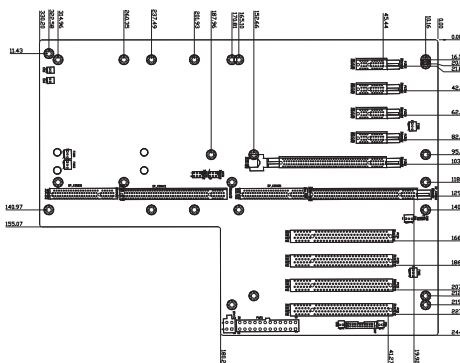
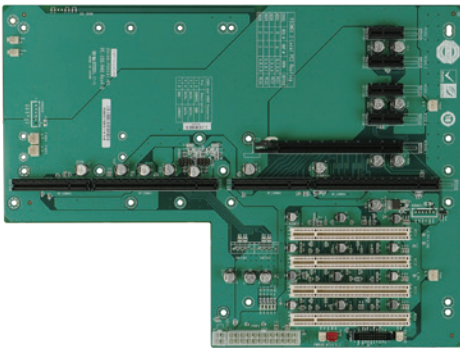

Ordering Information

PE-10S-R40	10-slot backplane with one PCIe x16 slot, four PCIe x1 slots and four PCI slots
RACK-305G	4U 14-slot full-size rack-mount chassis
RACK-360G	4U 14-slot full-size rack-mount chassis
RACK-3000G	4U 14-slot full-size rack-mount chassis

PE-10S2-R40

Mounting holes compatible with PCI-14S

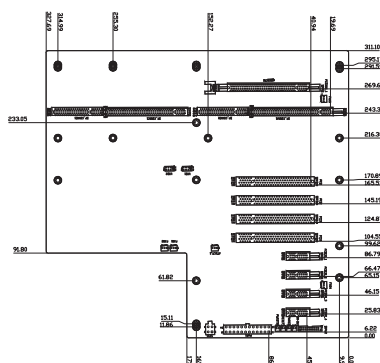
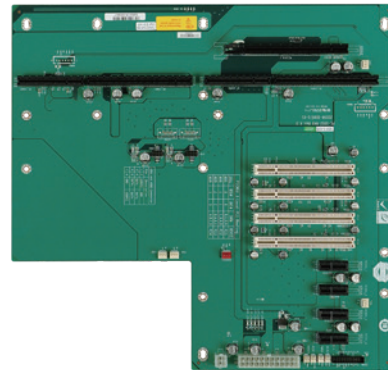

Ordering Information

PE-10S2-R40	10-slot backplane with one PCIe x16 slot, four PCIe x1 slots and four PCI slots
RACK-3000G	4U 14-slot full-size rack-mount chassis
RACK-305G	4U 14-slot full-size rack-mount chassis
RACK-360G	4U 14-slot full-size rack-mount chassis

PE-13SD-R40

Mounting holes compatible with PCI-14S

Dual system

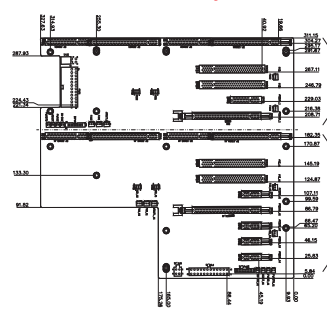
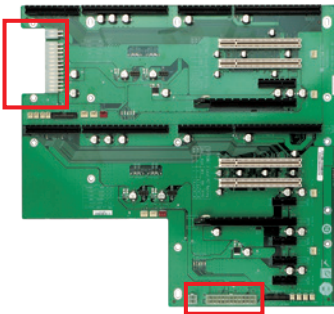

2 independent power resources

Ordering Information

PE-13SD-R40	13-slot backplane with two PCIe x16 slots, one PCIe x4 slot, four PCIe x1 slot and four PCI slots
RACK-3000G	4U 14-slot full-size rack-mount chassis
RACK-305G	4U 14-slot full-size rack-mount chassis
RACK-360G	4U 14-slot full-size rack-mount chassis

PXE-9S2-R10

Mounting holes compatible with PCI-14S

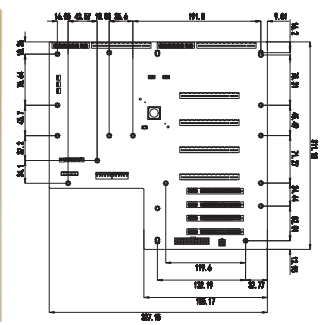
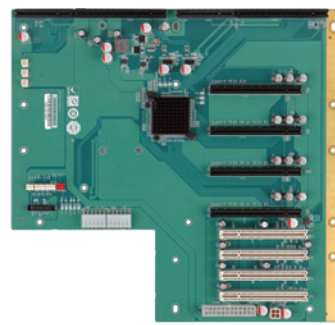

Ordering Information

PXE-9S2-R10	9-slot PICMG 1.3 backplane with one PCIe x16 by x16 slot, three PCIe x4 by x16 slots, and four PCI slots RoHS
RACK-305G	4U 14-slot full-size rack-mount chassis
RACK-360G	4U 14-slot full-size rack-mount chassis
RACK-3000G	4U 14-slot full-size rack-mount chassis

PXE-12S-R11

Mounting holes compatible with PCI-14S

(PCIe to PCI-X Bridge)

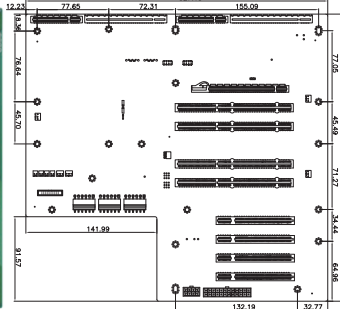
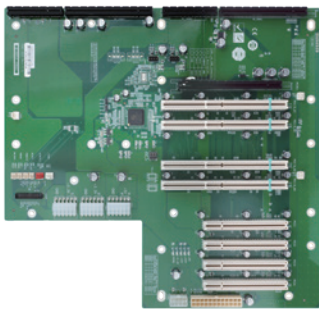

Ordering Information

PXE-12S-R11	12-slot backplane with one PCIe x16 slot, four PCI-X slots and four PCI slots
RACK-3000G	4U 14-slot full-size rack-mount chassis
RACK-305G	4U 14-slot full-size rack-mount chassis
RACK-360G	4U 14-slot full-size rack-mount chassis

PXE-13S-R51

Mounting holes compatible with PCI-14S

(PCIe to PCI Bridge)

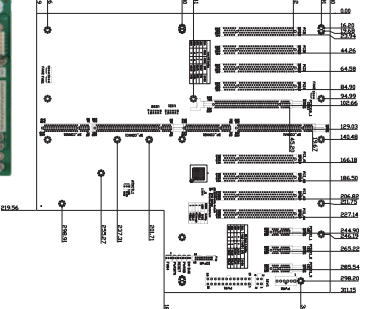
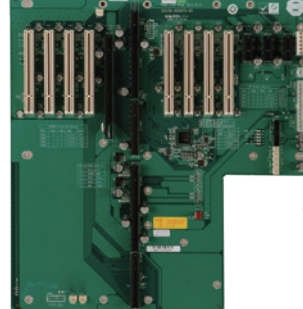

Ordering Information

PXE-13S-R51	13-slot backplane with one PCIe x16 slot, three PCIe x1 slots and eight PCI slots
RACK-3000G	4U 14-slot full-size rack-mount chassis
RACK-305G	4U 14-slot full-size rack-mount chassis
RACK-360G	4U 14-slot full-size rack-mount chassis

PXE-19S2-R10

Mounting holes compatible with PCI-19S

(PCIe to PCI Bridge)

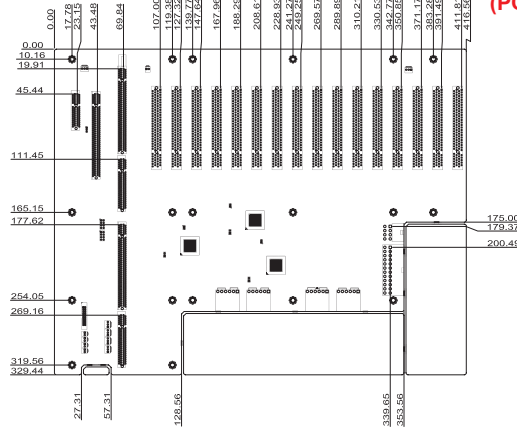
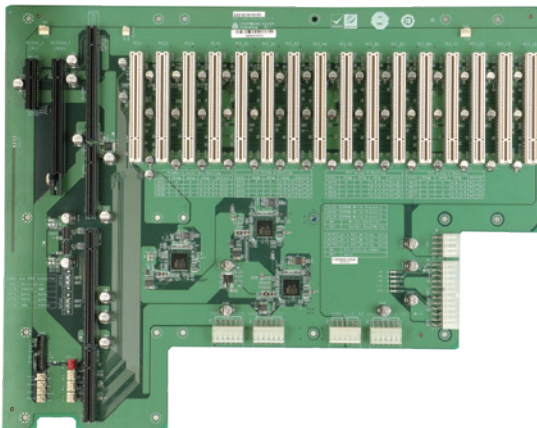

Ordering Information

PXE-19S2-R10	19-slot backplane with one PCIe x16 slot, one PCIe x1 slot and sixteen PCI slots
--------------	--

Full-size PICMG 1.0 Selection Guide



Model Name	WSB-BT	WSB-H810	WSB-H610
CPU Socket	On board	LGA 1150	LGA 1155
CPU Type	Intel® Celeron® J1900 on-board SoC (2GHz, quad-core, 2MB cache, TDP=10W) Intel® Celeron® N2807 on-board SoC (1.58GHz, dual-core, 2MB cache, TDP=4.3W)	Intel® Core™ i7/i5/i3, Pentium®, Celeron® processor	Intel® Core™ i7/i5/i3, Pentium®, Celeron® processor
Chipset	N/A	Intel® H81	Intel® H61
Memory	One 204-pin 1066/1333 MHz singlechannel DDR3L SDRAM unbuffered DIMM (system max. 8 GB)	Two 240-pin 1600/1333 MHz dual-channel DDR3 & DDR3L SDRAM unbuffered DIMMs (system max. 16 GB)	Two 240-pin 1333/1066 MHz dual-channel DDR3 & DDR3L (1.35V) DIMMs supported (system max. 16 GB)
Display Interface	Triple display supported 1 x VGA 1 x 18/24-bit dual-channel LVDS 1 x iDP interface for HDMI, LVDS, VGA, DVI, DP	Dual display supported 1 x VGA 1 x iDP interface	1 x VGA 1 x DVI-D (via header to IO-KIT-001-R20 DVI-D/USB module) (optional)
Ethernet	LAN1: Intel® I211-AT PCIe controller LAN2: Intel® I211-AT PCIe controller	LAN1: Intel® I217-V LAN PHY LAN2: Intel® I211-AT Ethernet controller	LAN1: Realtek RTL8111E PCIe GbE controller with ASF 2.0 support LAN2: Realtek RTL8111E PCIe GbE controller
I/O Interface	1 x KB/MS 1 x LPT 1 x USB 3.1 Gen 1 2 x RS-232/422/485 4 x RS-232 6 x USB 2.0	1 x 6-pin wafer for KB/MS 1 x LPT 1 x RS-422/485 2 x USB 3.1 Gen 1 4 x RS-232 8 x USB 2.0	1 x 6-pin wafer for KB & MS 1 x FDD 1 x LPT 1 x PS/2 KB/MS 1 x RS-422/485 2 x RS-232 7 x USB 2.0
Storage Interface	1 x mSATA (colay SATA2, supports SATA 3Gb/s signal only) 1 x CF Type II 2 x SATA 3Gb/s	1 x SATA 3Gb/s 2 x SATA 6Gb/s	4 x SATA 3Gb/s
Audio	IEI AC-KIT-892HD-R10 7.1-channel HD Audio kit via the on-board 10-pin header connector		
Digital I/O	8-bit digital I/O		
Power Consumption	3.3V@0.009A, 5V@4.68A, 5Vsb@0.008A, 12V@1.143A (Intel® Celeron® J1900 1.99 GHz 10W CPU with 8GB 1600MHz DDR3L memory)	5V@3.41A, 12V@0.35A, Vcore_12V@7.52A, 3.3V@1.41A, 5VSB@0.12A (Intel® Core™ i7-4770K 3.90 GHz CPU with 8 GB (two 4 GB) 1333 MHz DDR3 memory)	5V@4.53A, 12V@0.19A, Vcore_12V@7.81A, 5VSB@0.18A (3.4GHz Intel® Core™ i7-2600K with two 2 GB 1333 MHz DDR3 memory)
Watchdog Timer	Software programmable and supports 1~255 sec. system reset		
Operation Environment	Temperature Range: -20°C ~ 60°C (-4°F ~ 140°F) Relative Humidity: 5% ~ 95%, non-condensing		Temperature Range: -10°C ~ 60°C Relative Humidity: 5% ~ 95%, non-condensing
Expansion Slot	1 x Full/Half-size PCIe Mini card slot (support mSATA)	1 x Full/Half-size PCIe Mini card slot (support mSATA)	1 x Full/Half-size PCIe Mini card slot
CPU Cooler	Heatsink	CF-1150SB-R11 CF-1150SC-R20 CF-1150SE-R11 CF-1150SF-R10	CF-115XA-R10 CF-1156C-R20 CF-1156D-R20 CF-115XE-R10

WSB-BT

Full-size PICMG 1.0 CPU Card supports Intel® Celeron™ on-board SoC with VGA, iDP, Dual Intel® PCIe GbE, USB 3.1 Gen 1 (5Gb/s), PCIe Mini, SATA, mSATA, COM, CF, Audio and RoHS

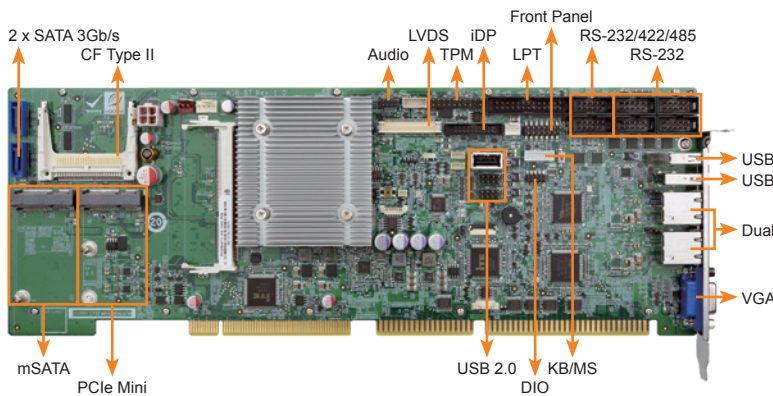

Multiple Choice for Storage

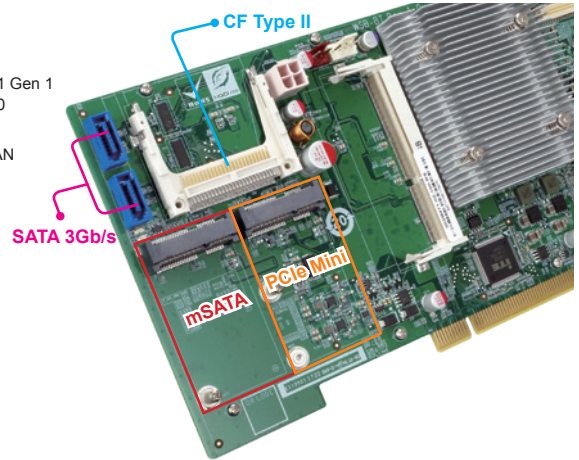

Specifications

- ◆ CPU
 - Intel® Celeron® J1900 on-board SoC (2GHz, quad-core, 2MB cache, TDP=10W)
 - Intel® Celeron® N2807 on-board SoC (1.58GHz, dual-core, 2MB cache, TDP=4.3W)
- ◆ Memory
 - One 204-pin 1333/1066MHz dual-channel DDR3L SDRAM unbuffered DIMM supports up to 8GB (J1900) or 4GB (N2807)
- ◆ BIOS
 - AMI UEFI BIOS
- ◆ Graphics
 - Intel® HD Graphics Gen 7 Engines with 4 execution units, supports DX11.1, OpenGL 4.2 and OpenCL1.2
- ◆ Display Output
 - 1 x VGA (up to 1920x1200@60Hz)
 - 1 x 18/24-bit dual-channel LVDS (up to 1920x1200@60Hz)
 - 1 x iDP interface for HDMI, LVDS, VGA, DVI, DP (up to 2560x1600@60Hz)
- ◆ Ethernet
 - LAN1: Intel® I211-AT PCIe controller
 - LAN2: Intel® I211-AT PCIe controller
- ◆ External I/O
 - 1 x USB 3.1 Gen 1 (5Gb/s)
 - 1 x USB 2.0
- ◆ Internal I/O
 - 1 x CF Type II
 - 1 x KB/MS (1x6 pin)
 - 1 x LPT (2x13 pin)
 - 1 x mSATA (SATA 3Gb/s)
 - 1 x USB 2.0 (180° Type-A)
 - 2 x RS-232/422/485 (2x5 pin, P=2.54)
 - 2 x SATA 3Gb/s
 - 4 x RS-232 (2x5 pin, P=2.54)
 - 4 x USB 2.0 (2x4 pin, P=2.54)
- ◆ Front Panel
 - 1 x Front panel (Power LED, HDD LED, Speaker, Power Button, Reset Button)
- ◆ Digital I/O
 - 8-bit digital I/O (2x5 pin)
- ◆ TPM
 - 1 x TPM (2x10 pin)
- ◆ Audio
 - 7.1 channel HD Audio supported by IEI AC-KIT-892HD kit
- ◆ SMBus
 - 1 x SMBus (1x4 pin)
- ◆ I²C
 - 1 x I²C (1x4 pin)
- ◆ Expansion
 - 1 x Full/Half-size PCIe Mini card slot
 - PCI and ISA* signal via golden finger
- ◆ Watchdog Timer
 - Software programmable supports 1~255 sec. system reset
- ◆ Fan Connector
 - 1 x CPU smart fan (1x4 pin)
 - 1 x System smart fan (1x3 pin)
- ◆ Power Supply
 - 5V/12V, AT/ATX support
- ◆ Power Consumption
 - 3.3V@0.009A, 5V@4.68A, 5Vsb@0.008A, 12V@1.143A
 - (Intel® Celeron® J1900 1.99 GHz 10W CPU with 8GB 1600MHz DDR3L memory)
- ◆ Operating Temperature
 - 20°C ~ 60°C
- ◆ Storage Temperature
 - 30°C ~ 70°C
- ◆ Operating Humidity
 - 5% ~ 95%, non-condensing
- ◆ Dimensions
 - 338 mm x 122 mm
- ◆ Weight
 - GW: 1000g / NW: 260g
- ◆ CE/FCC compliant

Features

- Full-size PICMG 1.0 with Intel® Celeron™ J1900 & N2807 on-board SoC
- Dual-channel 1066/1333MHz DDR3L SO-DIMM supports up to 8GB of memory
- Dual Gigabit Ethernet LAN controller
- SATA 3Gb/s, USB 3.1 Gen 1 (5Gb/s), PCIe Mini, mSATA and CF card supported
- TPM v1.2 & 2.0 hardware security function supported by TPM module
- Stiffener bars

Packing List

1 x WSB-BT single board computer
1 x Dual RS-232 cable with bracket
1 x SATA cable
1 x QIG

Ordering Information

Part No.	Description
WSB-BT-J19001-R10	Full-size PICMG 1.0 CPU card supports Intel® Celeron™ J1900 on-board SoC with VGA, iDP, Dual Intel® PCIe GbE, PCIe Mini, USB 3.1 Gen 1 (5Gb/s), SATA, mSATA, COM, CF, Audio and RoHS
WSB-BT-N28071-R10	Full-size PICMG 1.0 CPU card supports Intel® Celeron™ N2807 on-board SoC with VGA, iDP, Dual Intel® PCIe GbE, PCIe Mini, USB 3.1 Gen 1 (5Gb/s), SATA, mSATA, COM, CF, Audio and RoHS
19800-000049-RS	LPT flat cable, 240mm, P=2.54
19800-000075-RS	PS/2 KB/MS cable with bracket, 220mm, P=2.0
32102-000100-200-RS	SATA power cable, MOLEX 5264-4P to SATA15P
DP-DP-R10	DisplayPort to DisplayPort converter board (for IEI iDP connector)
DP-DVI-R10	DisplayPort to DVI-D converter board (for IEI iDP connector)
DP-HDMI-R10	DisplayPort to HDMI converter board (for IEI iDP connector)
DP-LVDS-R10	DisplayPort to LVDS converter board (for IEI iDP connector)
DP-VGA-R10	DisplayPort to VGA converter board (for IEI iDP connector)
AC-KIT-892HD-R10	7.1 channel HD Audio kit with Realtek ALC892 support dual audio stream
TPM-IN01-R20	20-pin Infineon TPM1.2 module, software management tool, firmware v3.17
TPM-IN02-R20	20-pin Infineon TPM2.0 module, software management tool, firmware v5.5

* ISA Limitation. Please refer to the manual for more information.

WSB-H810

Full-size PICMG 1.0 CPU Card supports LGA 1150 Intel® Core™ i7/i5/i3, Pentium® and Celeron® CPU with Intel® H81, DDR3, VGA, iDP, Dual Intel® GbE, PCIe Mini, USB 3.1 Gen 1 (5Gb/s), SATA 6Gb/s, mSATA, RS-232, HD Audio and RoHS

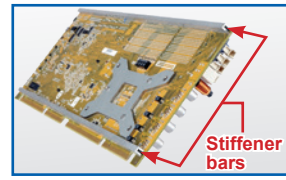
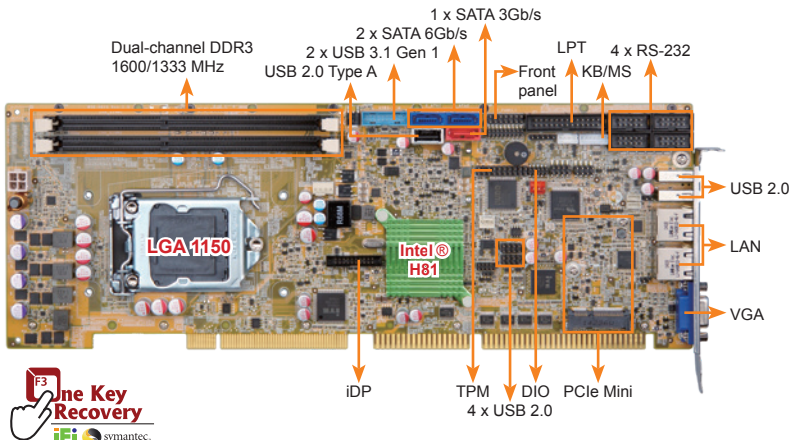

Enhanced stability
Strengthen the mechanism
Prevent PCB bending

PCIe Mini & mSATA connector

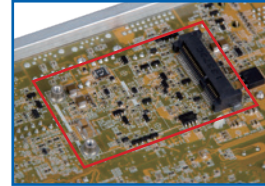

Support PCIe Mini & mSATA

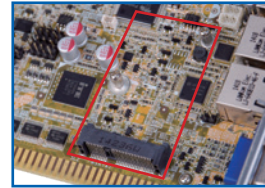

Top-side PCIe Mini connector supports PCIe signal for half-size or full-size PCIe device. Solder-side PCIe Mini connector supports SATA 3Gb/s signal for full-size mSATA.



Specifications

- ◆ CPU
4th generation LGA 1150 Intel® Core™ i7/i5/i3, Pentium® or Celeron® processor supported
- ◆ Chipset
Intel® H81
- ◆ Memory
Twp 240-pin 1600/1333 MHz dual-channel DDR3 & DDR3L SDRAM unbuffered DIMMs support up to 16 GB
- ◆ BIOS
UEFI
- ◆ Graphics Engine
Intel® HD Graphics Gen 7.5 supports DX11.1 and OpenCL 1.2, OpenGL 3.2
Full MPEG2, VC1, AVC Decode
- ◆ Display Output
Dual independent display
1 x VGA (up to 1920x1200@60 Hz)
1 x iDP interface for HDMI, LVDS, VGA, DVI, DP (up to 3840x2160@60 Hz)
- ◆ Ethernet
LAN1: Intel® I217-LM Ethernet controller
LAN2: Intel® I211-AT Ethernet controller
- ◆ Audio
Supports 7.1-channel HD Audio by IEI AC-KIT-892HD-R10 kit
- ◆ External I/O Interface
2 x USB 2.0
- ◆ Internal I/O Interface
1 x KB/MS (1x6 pin) 2 x SATA 6Gb/s
1 x LPT (2x13 pin) 2 x USB 3.1 Gen 1 (5Gb/s) (2x10 pin)
1 x RS-422/485 (1x4 pin, P=2.0) 4 x RS-232 (2x5 pin, P=2.54)
1 x USB 2.0 (180° Type-A) 4 x USB 2.0 (2x4 pin, P=2.54)
1 x SATA 3Gb/s (AHCI supported, no RAID)
- ◆ Front Panel
1 x Front panel (2x7 pin, power LED, HDD LED, speaker, power button, reset button)
- ◆ LAN LED
2 x LAN LED (1x2 pin)
- ◆ Digital I/O
8-bit digital I/O (2x5 pin)
- ◆ TPM
1 x TPM (2x10 pin)
- ◆ SMBus
1 x SMBus (1x4 pin)
- ◆ I²C
1 x I²C (1x4 pin)
- ◆ Infrared Interface
1 x Infrared Interface (1x5 pin)
- ◆ Expansion
1 x Full-size PCIe Mini card slot (support mSATA)
PCI and ISA signal via golden finger
- ◆ Watchdog Timer
Software programmable supports 1~255 sec. system reset
- ◆ Fan Connector
1 x CPU smart fan (1x4 pin)
1 x System smart fan (1x3 pin)
- ◆ Power Supply: 5V/12V, AT/ATX support
- ◆ Power Consumption
5V@3.4A, 12V@0.36A, Vcore_12V@7.48A, 3.3V@1.42A, 5VSB@0.13A
(Intel® Core™ i7-4770K 3.90 GHz CPU with 8 GB (two 4 GB) 1333 MHz DDR3 memory)
- ◆ Operating Temperature: -20°C ~ 60°C
- ◆ Storage Temperature: -30°C ~ 70°C
- ◆ Operating Humidity: 5% ~ 95%, non-condensing
- ◆ Dimensions: 338 mm x 122 mm
- ◆ Weight: GW: 1000g / NW: 260g
- ◆ CE/FCC compliant

Features

- Full-size PICMG 1.0 with LGA 1150 Intel® CPU
- Two 1600/1333 MHz DDR3 SDRAM DIMM slots support up to 16 GB of memory
- Dual Intel® Gigabit Ethernet LAN controller
- SATA 6Gb/s and USB 3.1 Gen 1 (5Gb/s) supported
- IEI One Key Recovery solution for rapid OS backup and recovery
- TPM v1.2 hardware security function supported by TPM module
- Stiffener bars
- IEI jumper-less function

Packing List

1 x WSB-H810 single board computer	
2 x SATA cable	1 x QIG

Ordering Information

Part No.	Description
WSB-H810-R10	Full-size PICMG 1.0 CPU card supports LGA 1150 Intel® Core™ i7/i5/i3, Pentium® and Celeron® CPU with Intel® H81, DDR3, VGA, iDP, dual Intel® GbE, PCIe Mini, USB 3.1 Gen 1 (5Gb/s), SATA 6Gb/s, mSATA, RS-232, HD Audio and RoHS
19800-000049-RS	LPT flat cable, 240mm, P=2.54
19800-000075-RS	PS/2 KB/MS cable with bracket, 220mm, P=2.0
19800-003100-100-RS	Dual port USB 2.0 cable with bracket, 300mm, P=2.54
19800-010500-200-RS	USB 3.1 Gen 1 (5Gb/s) cable with bracket, 450mm
32102-000100-200-RS	SATA power cable, MOLEX 5264-4P to SATA15P
32200-074800-RS	RS-422/485 cable, 200mm, P=2.0
32205-000702-100-RS	RS-232 cable, 230mm, P=2.54
AC-KIT-892HD-R10	7.1-channel HD Audio kit with Realtek ALC892 supports dual audio streams
CF-1150SB-R11	Special cooler kit for LGA 1150, high-performance compatible, 65W
CF-1150SC-R20	Special cooler kit for LGA 1150, 1U chassis compatible, 65W
CF-1150SE-R11	Special cooler kit for LGA 1150, high-performance compatible, 95W
CF-1150SF-R10	Special cooler kit for LGA 1150, 1U chassis compatible, 54W
DP-DP-R10	DisplayPort to DisplayPort converter board (for IEI iDP connector)
DP-DVI-R10	DisplayPort to DVI-D converter board (for IEI iDP connector)
DP-HDMI-R10	DisplayPort to HDMI converter board (for IEI iDP connector)
DP-LVDS-R10	DisplayPort to LVDS converter board (for IEI iDP connector)
DP-VGA-R10	DisplayPort to VGA converter board (for IEI iDP connector)
TPM-IN01-R20	20-pin Infineon TPM module, software management tool, firmware v3.17

WSB-H610-R11

Full-size PICMG 1.0 CPU Card supports 32nm LGA 1155 Intel® Core™ i7/i5/i3, Pentium® or Celeron® CPU with Intel® H61, DDR3, VGA, DVI-D, Dual Realtek PCIe GbE, USB 2.0, SATA 3Gb/s, COM, HD Audio and RoHS

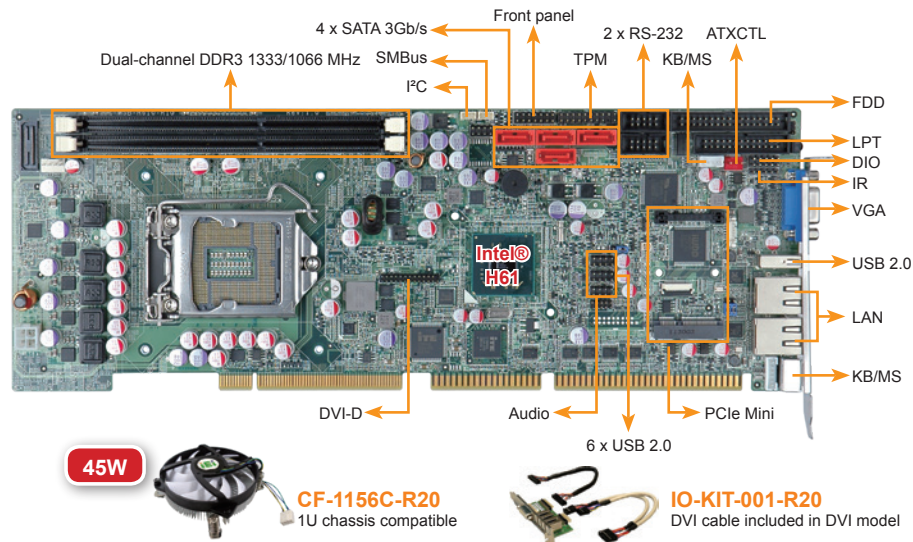

Specifications

- ◆ CPU
LGA 1155 socket supports Intel® Core™ i7/i5/i3, Pentium® or Celeron® processor
- ◆ Chipset
Intel® H61
- ◆ Memory
Two 240-pin 1333/1066 MHz dual-channel DDR3 & DDR3L SDRAM unbuffered DIMMs support up to 16 GB
- ◆ BIOS
UEFI
- ◆ Graphics Engine
Intel® HD Graphics Gen 6 supports DX10.1 and OpenGL 3.0
Full MPEG2, VC1, AVC Decode
- ◆ Display Output
1 x VGA (up to 2048x1536@75Hz)
1 x DVI-D (up to 1920x1200@60Hz)
(via header to IO-KIT-001-R20 DVI-D/USB module) (optional)
- ◆ Ethernet
LAN1: Realtek RTL8111E PCIe GbE controller with ASF 2.0 support
LAN2: Realtek RTL8111E PCIe GbE controller
- ◆ External I/O Interface
1 x KB/MS 1 x USB 2.0
- ◆ Internal I/O Interface
1 x FDD (2x17 pin) 1 x KB/MS (1x6 pin)
1 x LPT (2x13 pin) 1 x RS-422/485 (1x4 pin, P=2.0)
2 x RS-232 (2x5pin, P=2.54) 4 x SATA 3Gb/s (no AHCI & RAID support)
6 x USB 2.0 (2x4 pin, P=2.54)
- ◆ Audio
Supports 7.1-channel HD Audio by IEI AC-KIT-892HD-R10 kit
- ◆ Front Panel
1 x Front panel (2x7 pin, power LED, HDD LED, speaker, power button, reset button)
- ◆ TPM
1 x TPM (2x10 pin)
- ◆ SMBus
1 x SMBus (1x4 pin)
- ◆ I²C
1 x I²C (1x4 pin)
- ◆ Expansion
PCI signal and ISA signal via golden finger
- ◆ Watchdog Timer
Software programmable supports 1~255 sec. system reset
- ◆ Digital I/O
8-bit digital I/O (2x5 pin)
- ◆ Fan Connector
1 x CPU smart fan (1x4 pin)
1 x System smart fan (1x4 pin)
- ◆ Power Supply
5V/12V, AT/ATX support
- ◆ Power Consumption
5V@4.53A, 12V@0.19A, Vcore_12V@7.81A, 5VSB@0.18A
(3.4GHz Intel® Core™ i7-2600K with two 2 GB 1333 MHz DDR3 memory)
- ◆ Operating Temperature
-10°C ~ 60°C
- ◆ Storage Temperature
-20°C ~ 70°C
- ◆ Operating Humidity
5% ~ 95%, non-condensing
- ◆ Dimensions
338 mm x 122 mm
- ◆ Weight
GW: 1000g / NW: 260g
- ◆ CE/FCC compliant

Features

- Full-size PICMG 1.0 CPU card with LGA 1155 Intel® Core™ i7/i5/i3, Pentium® or Celeron® processor supported
- Two DDR3 & DDR3L 1333/1066 MHz DIMM SDRAM support up to 16 GB
- Embedded controller on board supports infrared and PECI 2.0 technologies
- Dual Realtek PCIe GbE and LAN1 with ASF 2.0 support
- TPM V1.2 hardware security function supported by TPM module
- IEI One Key Recovery solution allows you to create raidp OS backup and recovery

Packing List

1 x WSB-H610 single board computer
1 x Dual RS-232 cable with bracket
1 x KB/MS Y cable
1 x USB cable
2 x SATA cable
1 x Mini jumper pack
1 x QIG

Ordering Information

Part No.	Description
WSB-H610-R11	Full-size PICMG 1.0 CPU card supports 32nm LGA 1155 Intel® Core™ i7/i5/i3, Pentium® or Celeron® CPU with Intel® H61, DDR3, VGA, dual Realtek PCIe GbE, USB 2.0, SATA 3Gb/s, COM, HD Audio and RoHS
WSB-H610-DVI-R11	Full-size PICMG 1.0 CPU card supports 32nm LGA 1155 Intel® Core™ i7/i5/i3, Pentium® or Celeron® CPU with Intel® H61, DDR3, VGA, DVI-D, dual Realtek PCIe GbE, USB 2.0, SATA 3Gb/s, COM, HD Audio and RoHS
19800-000049-RS	LPT flat cable, 240mm, P=2.54
19800-000075-RS	PS/2 KB/MS cable with bracket, 220mm, P=2.0
32006-000300-100-RS	PS/2 KB/MS Y-cable without bracket, 140mm/120mm
32102-000100-200-RS	SATA power cable, MOLEX 5264-4P to SATA15P
32200-000017-RS	FDD cable, 520mm, P=2.54
AC-KIT-892HD-R10	7.1-channel HD Audio kit with Realtek ALC892 supports dual audio streams
CF-115XA-R10	High performance LGA 1155/LGA 1156 cooler kit, 1U chassis compatible, 73W
CF-1156C-R20	LGA 1155/LGA 1156 cooler kit, 1U chassis compatible, 45W
CF-1156D-R20	LGA 1155/LGA 1156 cooler kit, 1U chassis compatible, 65W
CF-115XE-R10	High performance LGA 1155/LGA 1156 cooler kit, 95W
SAIDE-KIT01-R10	SATA to IDE/CF converter board
TPM-IN01-R20	20-pin Infineon TPM module, software management tool, firmware v3.17

PCI/PX Backplane

Supports PCI and ISA slot on one backplane! For PICMG 1.0 Single Board Computer

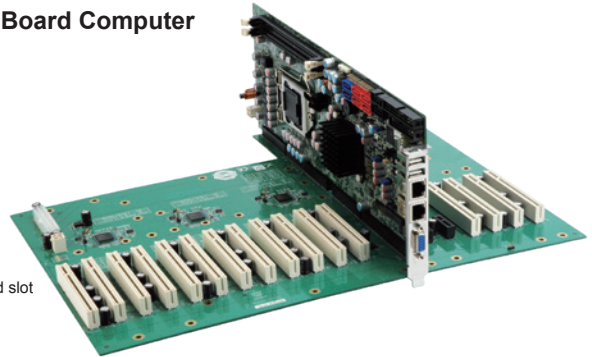

The advantages of using the PICMG 1.0 card are numerous:

1. Supports standard PICMG version 1.0 slot on the PCI/PX series passive backplane
2. Compatible with all available PCI/ISA cards. PCI/PX backplane is also integrated with the ROCKY series card slot

Selection Guide

PAC series wall-mount chassis

4U/5U rack-mount chassis

1U/2U rack-mount chassis

RoHS Ready



RoHS Ready



RoHS Ready



RoHS Ready



RoHS Ready



RoHS Ready



Model	PCI-4S-RS-R40	PCI-5S-RS-R40	PCI-5S2A-RS-R40 PCI-5S2-RS-R40	PCI-6S-RS-R40	PCI-7S-RS-R41	PCI-8S-RS-R40
Total Slot	4	5	5	6	7	8
PCI Slot	3	3	4	4	4	4
ISA Slot	1	2	1	2	3	4
PSU Type	ATX/AT	ATX/AT	ATX/AT	ATX/AT	ATX/AT	ATX/AT
Chassis	N/A	PAC-1000G	RACK-500G	PAC-106G PAC-1000G	PAC-1700G	N/A

RoHS Ready



RoHS Ready



RoHS Ready



RoHS Ready



RoHS Ready



RoHS Ready



Model	PCI-10S-RS-R41	PCI-10S2-RS-R41	PX-10S-RS-R50	PCI-12S-RS-R40	PCI-13SD-RS-R40	PCI-14S-RS-R40
Total Slot	10	10	10	12	13	14
PCI Slot	4	4	7	4	3+4	4
ISA Slot	5	5	3	7	3+3	9
PSU Type	ATX/AT	ATX/AT	ATX/AT	ATX/AT	ATX/AT	ATX/AT
Chassis	PAC-125G	N/A	PAC-125G	RACK-3000G	RACK-305G RACK-360G RACK-3000G	N/A
Note					For Dual System	

RoHS Ready



RoHS Ready



RoHS Ready



RoHS Ready



Model	PCI-14S2-RS-R40	PCI-14S3-RS-R40	PX-14S3-RS-R50	PX-14S5-RS-R50
Total Slot	14	14	14	14
PCI Slot	4	4	12	7
ISA Slot	8	9	2	6
PSU Type	ATX/AT	ATX/AT	ATX/AT	ATX/AT
Chassis	RACK-305G RACK-360G RACK-3000G	RACK-305G RACK-360G RACK-3000G	RACK-305G RACK-360G RACK-3000G	RACK-305G RACK-360G RACK-3000G

RoHS Ready



RoHS Ready



RoHS Ready

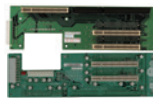

RoHS Ready



Model	PCI-2SD2-RS-R41	PCI-5SD6-RS-R40	PCI-5SDA-RS-R40	PCI-6SD-RS-R40
Total Slot	2	6	6	6
PCI Slot	R2	L2+R2	L2+R2	L1+R1
ISA Slot				L1+R1
PSU Type	ATX/AT	ATX	ATX/AT	ATX
Chassis	RACK-1150G	RACK-220G	RACK-220G	RACK-220G

PCI-4S-RS-R40

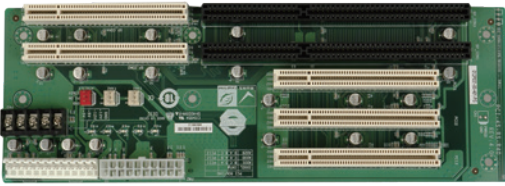

Ordering Information

PCI-4S-RS-R40 4-slot backplane with three PCI slots and one ISA slot

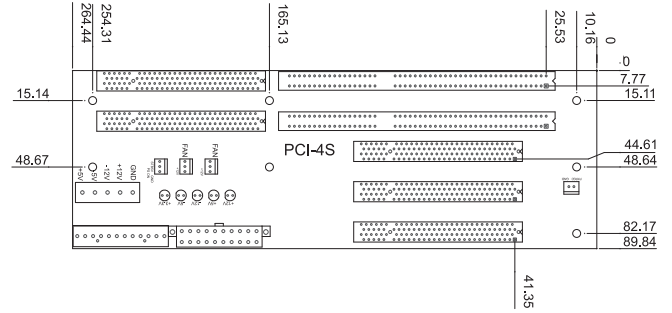

PCI-5S-RS-R40

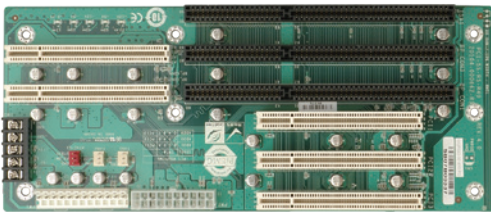

Ordering Information

PCI-5S-RS-R40 5-slot backplane with three PCI slots and two ISA slots

PAC-1000G 6-slot full-size compact chassis

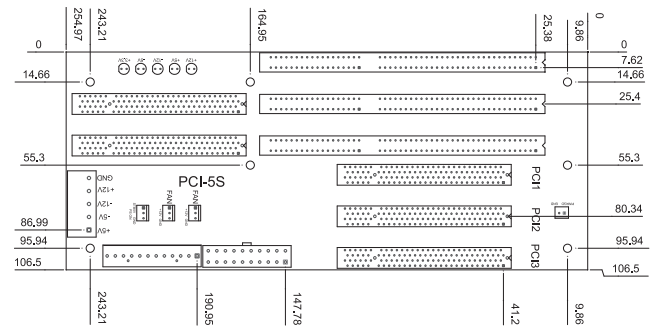

PCI-5S2-RS-R40/PCI-5S2A-RS-R40

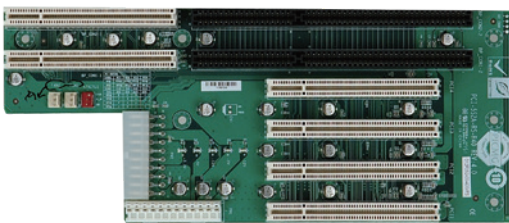

Ordering Information

PCI-5S2-RS-R40 5-slot AT power backplane with four PCI slots and one ISA slot

PCI-5S2A-RS-R40 5-slot ATX power backplane with four PCI slots and one ISA slot

RACK-500G 5-slot full-size compact chassis

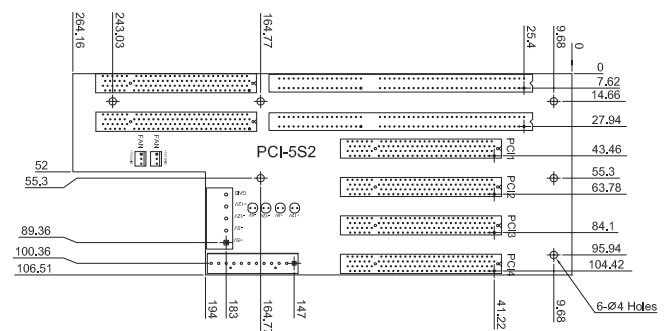

PCI-6S-RS-R40

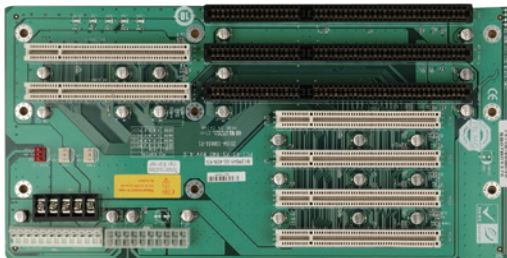

Ordering Information

PCI-6S-RS-R40 6-slot backplane with four PCI slots and two ISA slots

PAC-106G 6-slot full-size compact chassis

PAC-1000G 6-slot full-size compact chassis

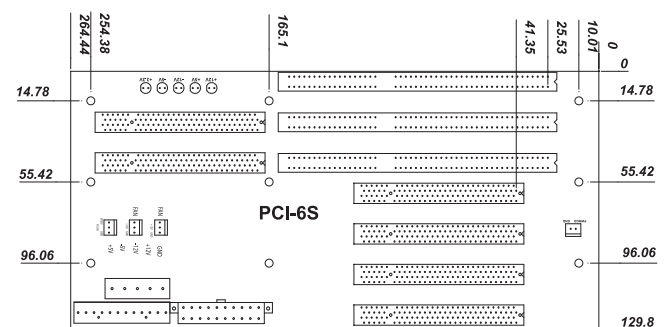

PCI-7S-RS-R41

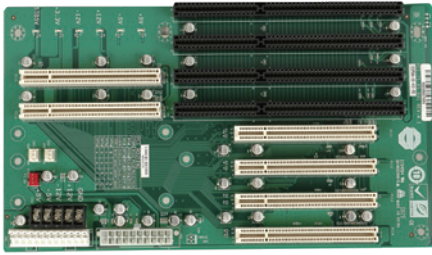

Ordering Information

PCI-7S-RS-R41 7-slot backplane with four PCI slots and three ISA slots
 PAC-1700G 7-slot full-size compact chassis

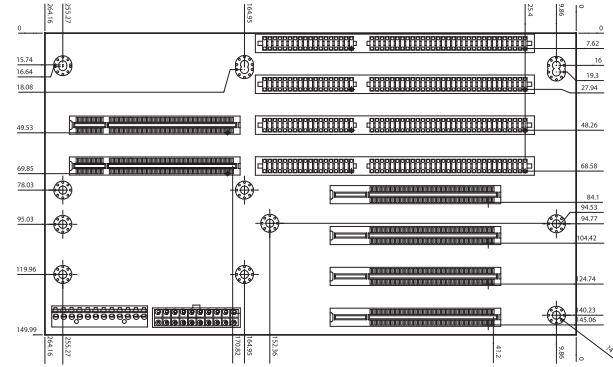

PCI-8S-RS-R40

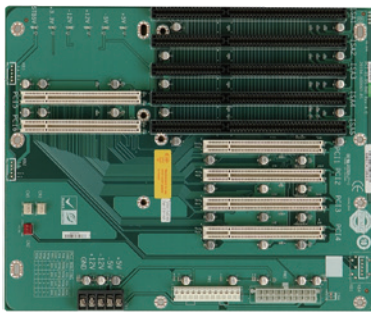

Ordering Information

PCI-8S-RS-R40 8-slot backplane with four PCI slots and four ISA slots

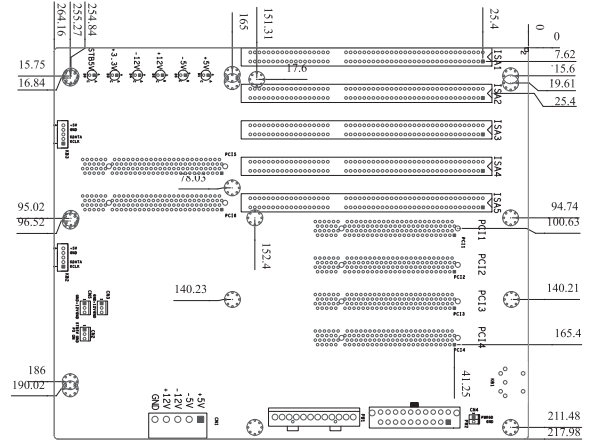

PCI-10S-RS-R41

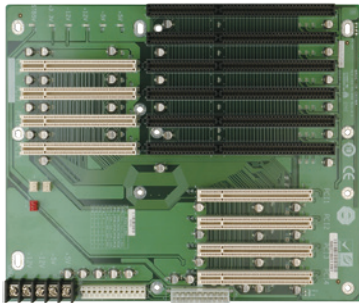

Ordering Information

PCI-10S-RS-R41 10-slot backplane with four PCI slots and five ISA slots
 PAC-125G 10-slot full-size compact chassis

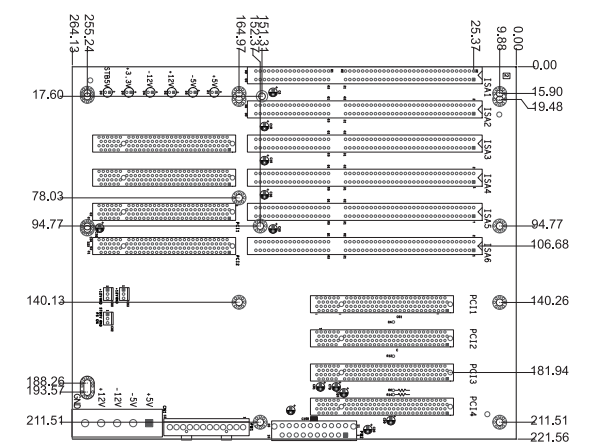

PX-10S-RS-R50

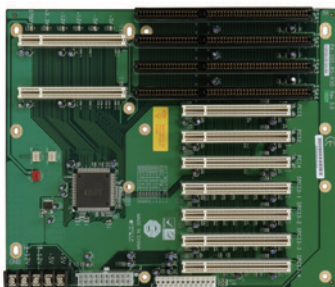

Ordering Information

PX-10S-RS-R50 10-slot backplane with seven PCI slots and three ISA slots
 PAC-125G 10-slot full-size compact chassis

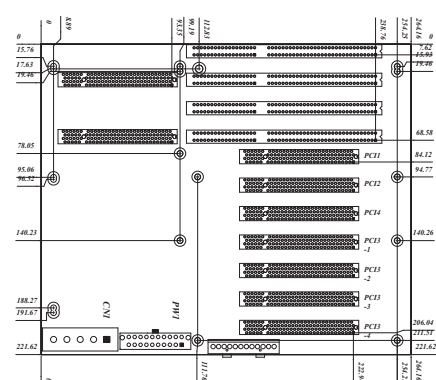

PCI-10S2-RS-R41

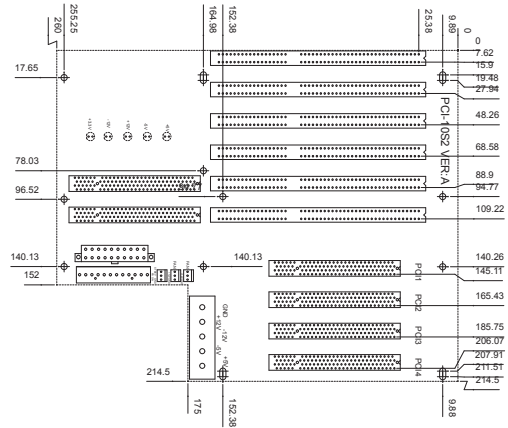
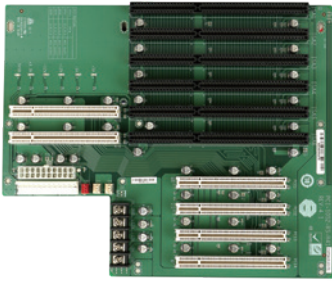

Ordering Information

PCI-10S2-RS-R41 10-slot backplane with four PCI slots and five ISA slots

PCI-12S-RS-R40

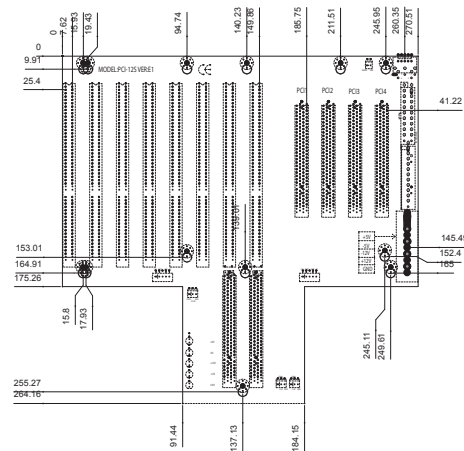
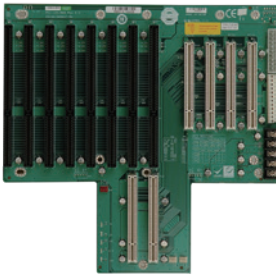

Ordering Information

PCI-12S-RS-R40 12-slot backplane with four PCI slots and seven ISA slots
 RACK-3000G 4U 14-slot full-size rack-mount chassis

PCI-13SD-RS-R40 Dual System

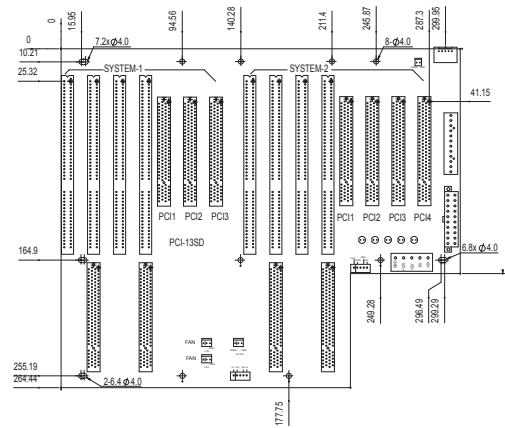
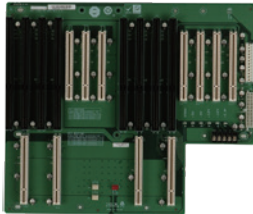

Ordering Information

PCI-13SD-RS-R40 13-slot dual-system backplane with system 1 having three PCI slots and three ISA slots and system 2 having four PCI slots and three ISA slots
 RACK-305G 4U 14-slot full-size rack-mount chassis
 RACK-360G 4U 14-slot full-size rack-mount chassis
 RACK-3000G 4U 14-slot full-size rack-mount chassis

PCI-14S-RS-R40

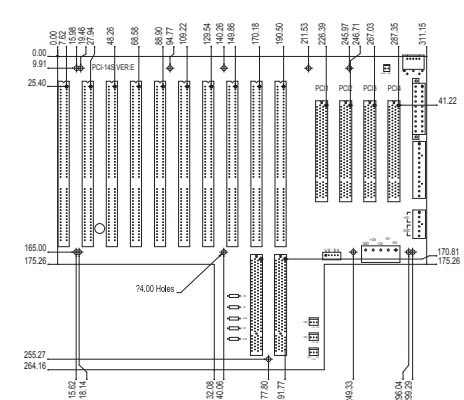
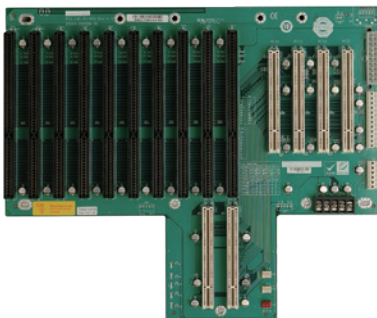

Ordering Information

PCI-14S-RS-R40 14-slot backplane with four PCI slots and nine ISA slots

PCI-14S2-RS-R40

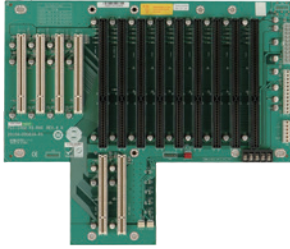

Ordering Information

PCI-14S2-RS-R40	14-slot backplane with four PCI slots and eight ISA slots
RACK-305G	4U 14-slot full-size rack-mount chassis
RACK-360G	4U 14-slot full-size rack-mount chassis
RACK-3000G	4U 14-slot full-size rack-mount chassis

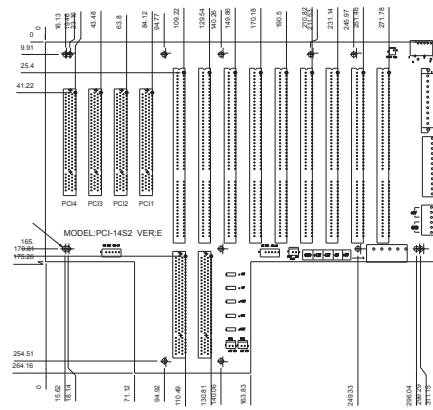

PCI-14S3-RS-R40

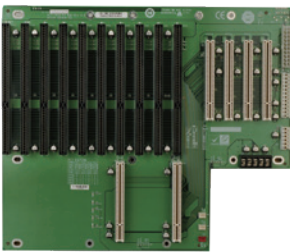

Ordering Information

PCI-14S3-RS-R40	14-slot backplane with four PCI slots and nine ISA slots
RACK-305G	4U 14-slot full-size rack-mount chassis
RACK-360G	4U 14-slot full-size rack-mount chassis
RACK-3000G	4U 14-slot full-size rack-mount chassis

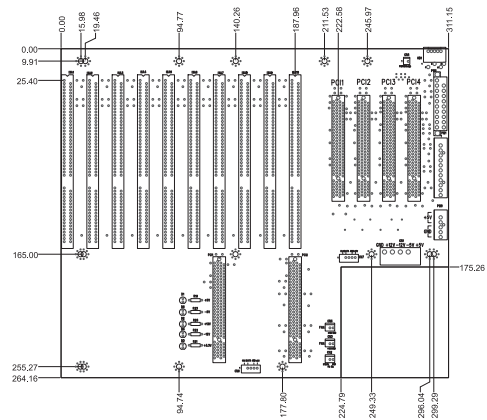

PX-14S3-RS-R50

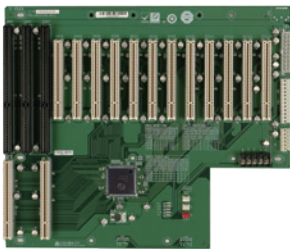

Ordering Information

PX-14S3-RS-R50	14-slot backplane with twelve PCI slots and two ISA slots
RACK-305G	4U 14-slot full-size rack-mount chassis
RACK-360G	4U 14-slot full-size rack-mount chassis
RACK-3000G	4U 14-slot full-size rack-mount chassis

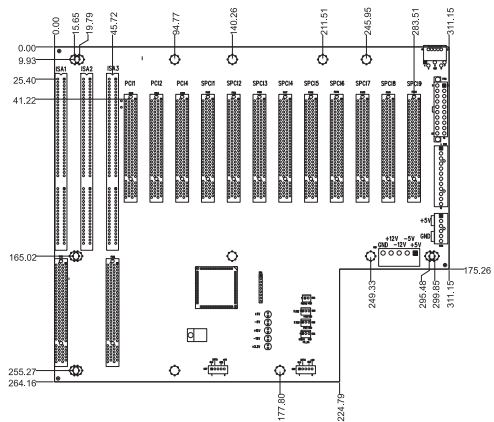

PX-14S5-RS-R50

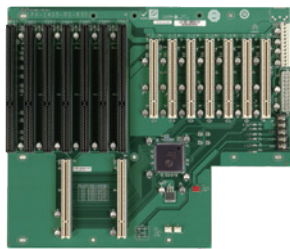

Ordering Information

PX-14S5-RS-R50	14-slot backplane with seven PCI slots and six ISA slots
RACK-305G	4U 14-slot full-size rack-mount chassis
RACK-360G	4U 14-slot full-size rack-mount chassis
RACK-3000G	4U 14-slot full-size rack-mount chassis

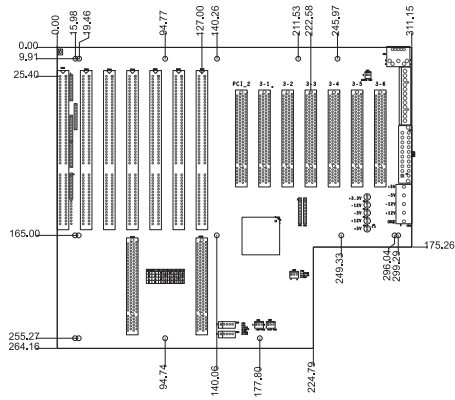

PCI-2SD2-RS-R41

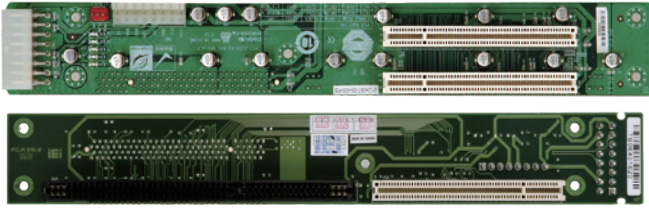

Ordering Information

PCI-2SD2-RS-R41	1U chassis backplane with two PCI slots
RACK-1150G	1U full-size rack-mount chassis

* The adapter cable 32100-040600-RS is required when connecting PCI-2SD2-RS to a standard ATX supply.

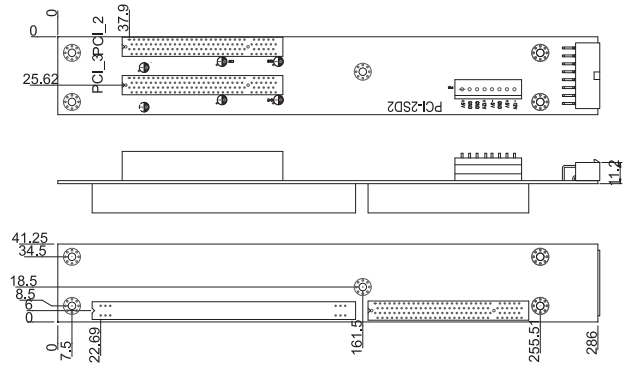

PCI-5SD6-RS-R40 2U Type

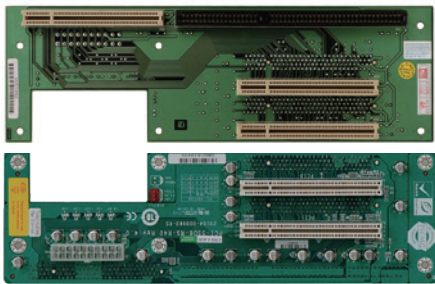

Ordering Information

PCI-5SD6-RS-R40	2U chassis backplane with four PCI slots
RACK-220G	2U 6-slot full-size rack-mount chassis

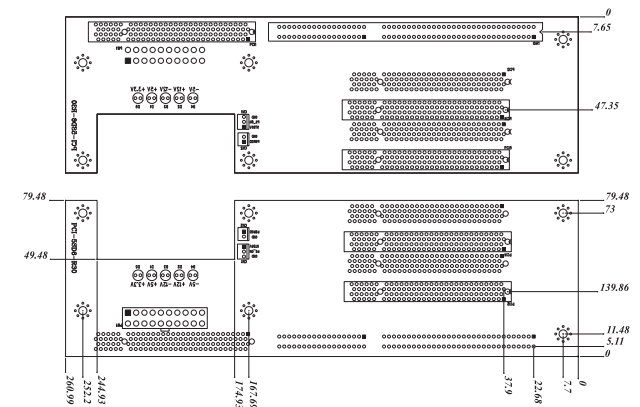

PCI-5SDA-RS-R40 2U Type

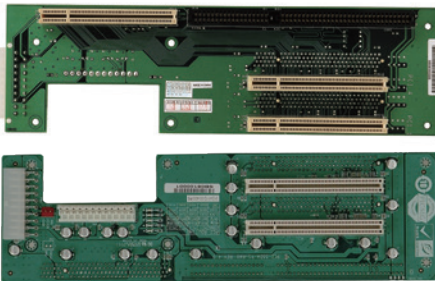

Ordering Information

PCI-5SDA-RS-R40	2U chassis backplane with four PCI slots
RACK-220G	2U 6-slot full-size rack-mount chassis

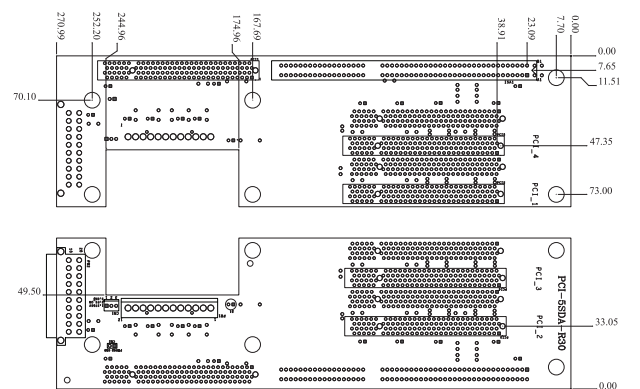

PCI-6SD-RS-R40 2U Type

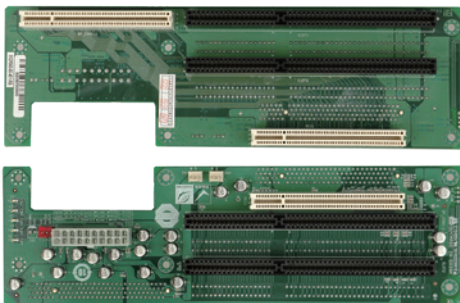

Ordering Information

PCI-6SD-RS-R40	2U chassis backplane with two PCI slots and two ISA slots
RACK-220G	2U 6-slot full-size rack-mount chassis

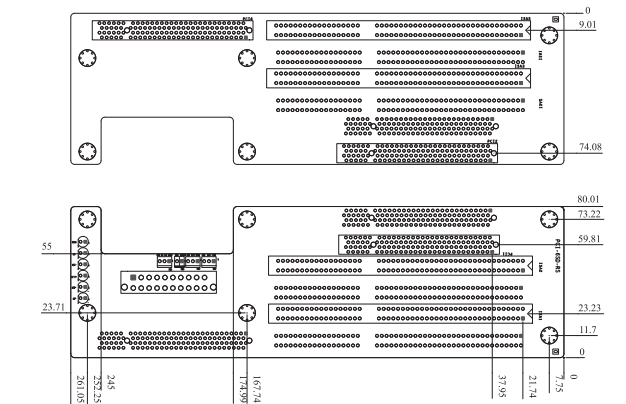

Half-size PICOe, ISA Selection Guide

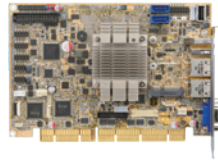
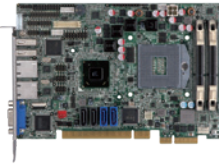

Model Name	PICOe-B650	PICOe-HM650	PCISA-BT	IOWA-LX
CPU Socket	LGA 1155	Socket G2	On board	On board
CPU Type	Socket LGA 1155 Intel® Core™ i7/i5/i3, Pentium® or Celeron® CPU	Socket 988B Intel® Mobile Core™ i7/i5/i3 or Celeron® CPU	Intel® Atom™ E3845 on-board SoC (1.91GHz, quad-core, 2MB cache, TDP=10W) Intel® Atom™ E3825 on-board SoC (1.33GHz, dual-core, 1MB cache, TDP=6W)	AMD Geode™ LX600
Chipset	Intel® B65	Intel® HM65	N/A	AMD Geode™ CS5536
Memory	One 204-pin 1333/1066 MHz DDR3/DDR3L (1.35V) SO-DIMM supported (system max. 8 GB)	Two 204-pin 1333/1066 MHz dual-channel DDR3 SO-DIMMs supported (system max. 16 GB)	One 204-pin 1066/1333 MHz single-channel DDR3L SDRAM unbuffered DIMM (system max. 8 GB)	On-board 128MB 200/266 MHz DDR SDRAM One 200-pin 200/266 MHz DDR SO-DIMM (system max. 512MB)
Display Interface	1 x VGA	Dual display supported 1 x VGA 1 x 18/24-bit dual-channel LVDS	Dual display supported 1 x VGA 1 x iDP interface	1 x VGA
Ethernet	LAN1: Realtek RTL8111E PCIe GbE controller with ASF 2.0 support LAN2: Realtek RTL8111E PCIe GbE controller	LAN1: Realtek RTL8111E GbE controller with ASF 2.0 support LAN2: Realtek RTL8111E GbE controller	LAN1: Intel® I211-AT PCIe controller LAN2: Intel® I211-AT PCIe controller	10/100Mbps Realtek RTL8100C Ethernet controller
I/O Interface	1 x 6-pin wafer for KB & MS 2 x RS-232 4 x USB 2.0	1 x 6-pin wafer for KB & MS 1 x LPT 1 x RS-422/485 2 x RS-232 8 x USB 2.0	1 x 6-pin wafer for KB/MS 1 x LPT 1 x RS-422/485 2 x RS-232 2 x USB 3.1 Gen 1 8 x USB 2.0	1 x Infrared interface 1 x LPT 1 x PS/2 KB/MS 1 x RS-422/485 2 x RS-232 4 x USB 2.0 (by pin header)
Storage Interface	1 x SATA 3Gb/s 1 x SATA 6Gb/s	2 x SATA 3Gb/s 2 x SATA 6Gb/s	1 x mSATA (colay SATA2, supports SATA 3Gb/s signal only) 2 x SATA 3Gb/s	1 x CF Type II 1 x FDD 1 x IDE 2 x SATA (RAID 0, 1)
Audio	IEI AC-KIT-892HD-R10 7.1-channel HD Audio kit via the on-board 10-pin header connector			Realtek ALC203 with AC'97 codec
Digital I/O	8-bit digital I/O			
Power Consumption	5V@3.17A, 12V@0.46A, Vcore_12V@7.26A, 5VSB@0.18A (3.4GHz Intel® Core™ i7-2600K with two 2 GB 1333 MHz DDR3 memory)	5V@3.99A, 12V@0.43A, Vcore_12V@3.80A, 5VSB@0.06A (2.70GHz Intel® Core™ i7-2620M with two 2 GB 1333 MHz DDR3 memory)	5V@1.55A, 12V@0.74A (Intel® Atom™ E3845 1.91GHz CPU, one 8 GB 1600 MHz memory)	5V@1.51A, 5VSB@0.09A (On-board AMD Geode™ LX600 CPU 366 MHz with on-board 128MB 200 MHz DDR memory and 512MB 333 MHz DDR memory)
Watchdog Timer	Software programmable supports 1~255 sec. system reset			
Operation Environment	Temperature Range: -10°C ~ 60°C Relative Humidity: 5% ~ 95%, non-condensing		Temperature Range: -20°C ~ 60°C (-4°F ~ 140°F) Relative Humidity: 5% ~ 95%, non-condensing	Temperature Range: 0°C ~ 60°C (32°F ~ 140°F) Relative Humidity: 5% ~ 95%, non-condensing
Expansion Slot	NA	NA	1 x PCIe Mini slot	NA
CPU Cooler	CF-115XA-R10 CF-1156C-R20 CF-1156D-R20 CF-115XE-R10	CF-989A-RS-R12	NA	Heatsink (fanless)

PIC0e CPU Card - The Future of Half-sized CPU Cards

ISA → PCISA → PCI → PIC0e

1990~

ISA

1996~

PCISA
ISA + PCI

2019~

PIC0e
PCI + PCIe x4

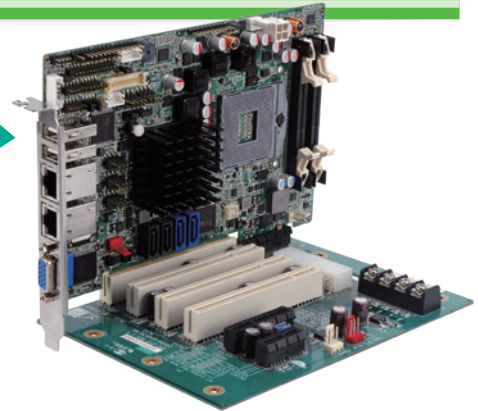

PIC0e-HM650

IEI Patent No CN.: 200986704Y
From SIPO (State Intellectual Property Office of The P.R.C)

The advantages of PIC0e

PIC0e = PCI + PCIe x4

- PCIe has excellent I/O bandwidth and performance
- Backwards compatible with half-sized CPU cards
- Backplane design for half-size PCIe CPU cards is easy

The benefits of PIC0e

- Same dimensions, backwards compatible but half the size of PCI SBC
- Higher performance as PCI only solution for the same price
- More configuration options for the same price

■ The advantages of PIC0e

● Increasing I/O bandwidth with leading technology

Specifications	ISA	PCI 33	PCIe x4
Support	(16 MB/s)	(132 MB/s)	(1250 MB/s)

● Backwards compatible with half-size PCI backplane and chassis

1. Dimensions: 185 mm x 122 mm
= All half-size CPU cards
Share the same chassis & I/O design
2. PCI pin definition same as PICMG 1.0 PCI
= All half-size PCI CPU cards

● Quick design backplane

1. Four PCI slots and one PCIe x4 or four PCIe x1 lanes
More configuration options on the backplane with a PCI and PCIe slot
2. PCIe switches and bridges such as PLX or TI solutions

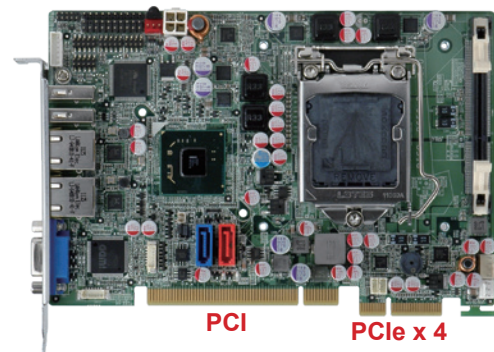
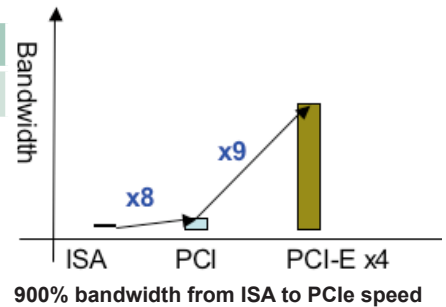
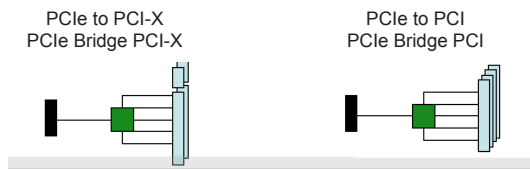

PIC0e-B650

■ IEI PIC0e backplane solutions

Complete PIC0e backplane solutions fully support all kinds of chassis and power modes. PIC0e is the easiest way to upgrade current systems from slow ISA+PCI architecture to the latest high performance PCIe+PCI solution.



CPU card (located on the right side of the first slot)

Model Name	PCI	PCIe x4	PCIe x1	PSU Type	Note
HPE-3S1	2			ATX/AT	CPU on R1st
HPE-3S2	1	1		ATX/AT	CPU on R1st
HPE-4S1	3			ATX/AT	CPU on R2nd
HPE-4S2	2	1		ATX/AT	CPU on R2nd
HPE-5S1	4			ATX/AT	CPU on R2nd
HPE-5S2	3	1		ATX/AT	CPU on R2nd
HPE-5S3	2	0	2	ATX/AT	CPU on R2nd
HPE-6S1	4	1		ATX/AT	CPU on R1st
HPE-7S1	4	0	2	ATX/AT	CPU on R2nd
HPE-8S0	4	0	2	ATX/AT	Reserved 1 Slot

PICOe-B650

Half-size PCIe CPU Card supports LGA 1155 32nm Intel® Core™ i7/i5/i3, Pentium® or Celeron® CPU with Intel® B65, DDR3, VGA, Dual Realtek PCIe GbE, USB 2.0, SATA 6Gb/s, HD Audio and RoHS

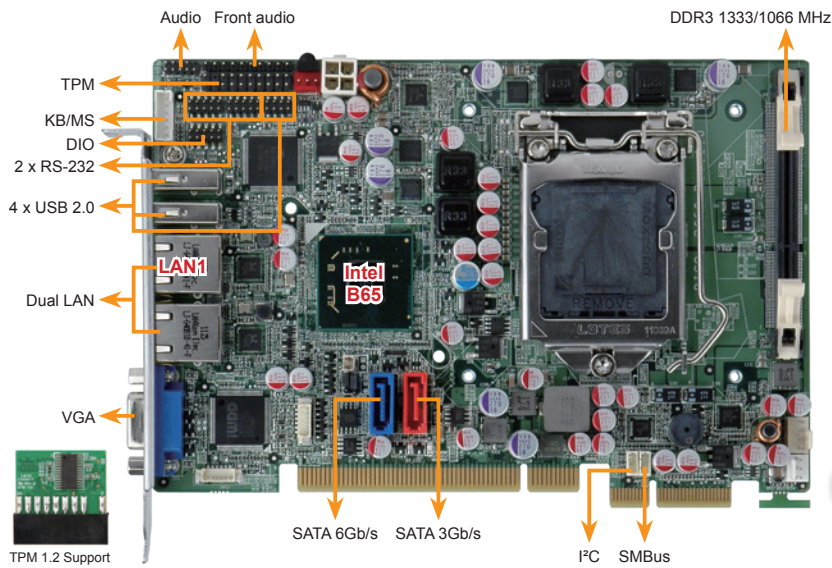

2nd Gen Intel® Core™ Processors (TDP=35W) Recommended List

CPU No.	Clock speed	Core	Smart cache	TDP
i5-2390T	2.7GHz	2	3M	35W
i3-2120T	2.6GHz	2	3M	35W
G630T	2.3GHz	2	3M	35W
G530T	2.0GHz	2	2M	35W
G440	1.6GHz	1	1M	35W



The 2nd generation Intel® processors provide advanced technology and intelligent performance.

Specifications

- ◆ CPU
LGA 1155 socket supports Intel® Core™ i7/i5/i3, Pentium® or Celeron® processor
- ◆ Chipset
Intel® B65
- ◆ Memory
One 240-pin 1333/1066 MHz dual-channel DDR3 & DDR3L SDRAM unbuffered DIMMs support up to 8 GB
- ◆ BIOS
UEFI
- ◆ Graphics Engine
Intel® HD Graphics Gen 6 supports DX10.1 and OpenGL 3.0
Full MPEG2, VC1, AVC decoding
- ◆ Display Output
1 x VGA (up to 2048x1536@75Hz)
- ◆ Ethernet
LAN1: Realtek RTL8111E PCIe GbE controller with ASF 2.0 support
LAN2: Realtek RTL8111E PCIe GbE controller
- ◆ External I/O Interface
2 x USB 2.0
- ◆ Internal I/O Interface
1 x KB/MS (1x6 pin) 1 x SATA 6Gb/s
1 x LPT (2x13 pin) 2 x RS-232 (2x5pin, P=2.0)
1 x SATA 3Gb/s 2 x USB 2.0 (2x4 pin, P=2.0)
- ◆ Audio
Supports 7.1-channel HD Audio by IEI AC-KIT-892HD-R10 kit
- ◆ Front Panel
1 x Front panel connector (1x10 pin, power LED, HDD LED, speaker, power button, reset button)
- ◆ TPM
1 x TPM (2x10 pin)
- ◆ SMBus
1 x SMBus (1x4 pin)
- ◆ I²C
1 x I²C (1x4 pin)
- ◆ Expansion
PCIe signal and PCI signal via golden finger
- ◆ Watchdog Timer
Software programmable supports 1~255 sec. system reset
- ◆ Digital I/O
8-bit digital I/O (2x5 pin)
- ◆ Fan Connector
1 x CPU smart fan (1x4 pin)
1 x System smart fan (1x4 pin)
- ◆ Power Supply
5V/12V, AT/ATX support
- ◆ Power Consumption
5V@3.17A, 12V@0.46A, Vcore_12V@7.26A, 5VSB@0.18A
(3.4GHz Intel® Core™ i7-2600K with two 2 GB 1333 MHz DDR3 memory)
- ◆ Operating Temperature
-10°C ~ 60°C
- ◆ Storage Temperature
-20°C ~ 70°C
- ◆ Operating Humidity
5% ~ 95%, non-condensing
- ◆ Dimensions
185 mm x 122 mm
- ◆ Weight
GW: 1000g / NW: 260g
- ◆ CE/FCC compliant



Features

- Half-size PCIe CPU card with LGA 1155 Intel® Core™ i7/i5/i3, Pentium® or Celeron® processor supported
- One 1333/1066 MHz DDR3/DDR3L (1.35V) SDRAM SO-DIMM supports up to 8 GB
- On-board embedded controller supports infrared and PECI 2.0 technologies
- One SATA 6Gb/s and dual Realtek PCIe GbE
- TPM V1.2 hardware security provided by the TPM module
- IEI One Key Recovery solution allows you to create rapid OS backup and recovery

Packing List

1 x PICOe-B650 single board computer	
1 x Dual RS-232 cable with bracket	
1 x USB cable	1 x Mini jumper pack
2 x SATA cable	1 x QIG

Ordering Information

Part No.	Description
PICOe-B650-R10	Half-size PCIe CPU card supports 32nm LGA 1155 Intel® Core™ i7/i5/i3, Pentium® or Celeron® CPU with Intel® B65, DDR3, VGA, dual Realtek PCIe GbE, USB 2.0, SATA 6Gb/s, HD Audio and RoHS
19800-000075-RS	PS/2 KB/MS cable with bracket, 220mm, P=2.0
32102-000100-200-RS	SATA power cable, MOLEX 5264-4P to SATA15P
AC-KIT-892HD-R10	7.1-channel HD Audio kit with Realtek ALC892 supports dual audio streams
CF-115XA-R10	High-performance LGA 1155/LGA 1156 cooler kit, 1U chassis compatible, 73W
CPU-DT-C-G440	Intel® Celeron® G440 processor, LGA -1155, single core 1.6GHz, 1M cache, 35W, compatible with CF-1156C-R20 CPU cooler
CPU-DT-i3-2120T	Intel® Core™ i3-2120T processor, LGA 1155, dual core 2.6GHz, 3M cache, 35W, compatible with CF-1156C-R20 CPU cooler
CPU-DT-i5-2390T	Intel® Core™ i5-2390T processor, LGA -1155, dual core 2.7GHz, 3M cache, 35W, AMT, compatible with CF-1156C-R20 CPU cooler
CPU-DT-i5-2500T	Intel® Core™ i5-2500T processor, LGA -1155, quad core 2.3GHz, 6M cache, 45W, compatible with CF-1156C-R20 CPU cooler
CPU-DT-P-G630T	Intel® Pentium® G630T processor, LGA 1155, dual core 2.3GHz, 3M cache, 35W, compatible with CF-1156C-R20 CPU cooler
SAIDE-KIT01-R10	SATA to IDE/CF converter board
TPM-IN01-R20	20-pin Infineon TPM module, software management tool, firmware v3.17

PIC0e-HM650

Half-size PCIe CPU Card supports Socket 988B Intel® Mobile Core™ i7/i5/i3 or Celeron® CPU with Intel® HM65, DDR3, VGA, LVDS, Dual PCIe GbE, SATA 6Gb/s, HD Audio and RoHS

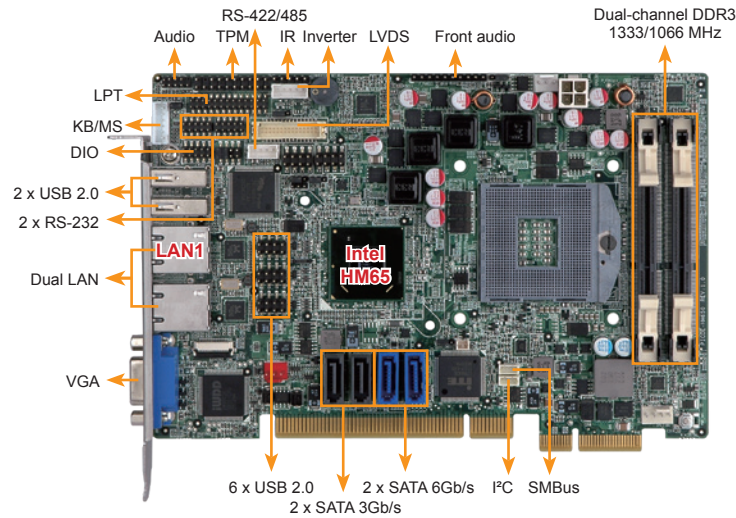

CPU cooler
P/N: CF-989A-RS-R12



TPM 2.0 Support



Specifications

- ◆ CPU
LGA 1155 socket supports Intel® Core™ i7/i5/i3, Pentium® or Celeron® processor
- ◆ Chipset
Intel® B65
- ◆ Memory
One 240-pin 1333/1066 MHz dual-channel DDR3 & DDR3L SDRAM unbuffered DIMMs support up to 8 GB
- ◆ BIOS
UEFI
- ◆ Graphics Engine
Intel® HD Graphics Gen 6 supports DX10.1 and OpenGL 3.0
Full MPEG2, VC1, AVC decoding
- ◆ Display Output
1 x VGA (up to 2048x1536@75Hz)
- ◆ Ethernet
LAN1: Realtek RTL8111E PCIe GbE controller with ASF 2.0 support
LAN2: Realtek RTL8111E PCIe GbE controller
- ◆ External I/O Interface
2 x USB 2.0
- ◆ Internal I/O Interface
1 x KB/MS (1x6 pin) 1 x SATA 6Gb/s
1 x LPT (2x13 pin) 2 x RS-232 (2x5pin, P=2.0)
1 x SATA 3Gb/s 2 x USB 2.0 (2x4 pin, P=2.0)
- ◆ Audio
Supports 7.1-channel HD Audio by IEI AC-KIT-892HD-R10 kit
- ◆ Front Panel
1 x Front panel connector (1x10 pin, power LED, HDD LED, speaker, power button, reset button)
- ◆ TPM
1 x TPM (2x10 pin)
- ◆ SMBus
1 x SMBus (1x4 pin)
- ◆ I²C
1 x I²C (1x4 pin)
- ◆ Expansion
PCIe signal and PCI signal via golden finger
- ◆ Watchdog Timer
Software programmable supports 1~255 sec. system reset
- ◆ Digital I/O
8-bit digital I/O (2x5 pin)
- ◆ Fan Connector
1 x CPU smart fan (1x4 pin)
1 x System smart fan (1x4 pin)
- ◆ Power Supply
5V/12V, AT/ATX support
- ◆ Power Consumption
5V@3.17A, 12V@0.46A, Vcore_12V@7.26A, 5VSB@0.18A
(3.4GHz Intel® Core™ i7-2600K with two 2 GB 1333 MHz DDR3 memory)
- ◆ Operating Temperature
-10°C ~ 60°C
- ◆ Storage Temperature
-20°C ~ 70°C
- ◆ Operating Humidity
5% ~ 95%, non-condensing
- ◆ Dimensions
185 mm x 122 mm
- ◆ Weight
GW: 1000g / NW: 260g
- ◆ CE/FCC compliant

Features

- Half-size PCIe CPU card supports Socket G2 32nm Intel® Core™ i7/i5/i3 or Celeron® processor
- Up to 16 GB 1333/1066 MHz dual-channel DDR3 SDRAM
- Supports 18/24-bit dual-channel LVDS and analog CRT output
- High-speed I/O interface provided through the 2nd gen PCIe add-on card and SATA 6Gb/s connectors
- Rich media acceleration for hardware encoding and decoding
- TPM V1.2 hardware security provided by the TPM module
- IEI One Key Recovery solution allows you to create raidp OS backup and recovery

Packing List

1 x PIC0e-B650 single board computer	
1 x Dual RS-232 cable with bracket	
1 x USB cable	1 x Mini jumper pack
2 x SATA cable	1 x QIG

Ordering Information

Part No.	Description
PIC0e-B650-R10	Half-size PCIe CPU card supports 32nm LGA 1155 Intel® Core™ i7/i5/i3, Pentium® or Celeron® CPU with Intel® B65, DDR3, VGA, dual Realtek PCIe GbE, USB 2.0, SATA 6Gb/s, HD Audio and RoHS
19800-000075-RS	PS/2 KB/MS cable with bracket, 220mm, P=2.0
32102-000100-200-RS	SATA power cable, MOLEX 5264-4P to SATA15P
AC-KIT-892HD-R10	7.1-channel HD Audio kit with Realtek ALC892 supports dual audio streams
CF-115XA-R10	High-performance LGA 1155/LGA 1156 cooler kit, 1U chassis compatible, 73W
CPU-DT-C-G440	Intel® Celeron® G440 processor, LGA -1155, single core 1.6GHz, 1M cache, 35W, compatible with CF-1156C-R20 CPU cooler
CPU-DT-i3-2120T	Intel® Core™ i3-2120T processor, LGA 1155, dual core 2.6GHz, 3M cache, 35W, compatible with CF-1156C-R20 CPU cooler
CPU-DT-i5-2390T	Intel® Core™ i5-2390T processor, LGA -1155, dual core 2.7GHz, 3M cache, 35W, AMT, compatible with CF-1156C-R20 CPU cooler
CPU-DT-i5-2500T	Intel® Core™ i5-2500T processor, LGA -1155, quad core 2.3GHz, 6M cache, 45W, compatible with CF-1156C-R20 CPU cooler
CPU-DT-P-G630T	Intel® Pentium® G630T processor, LGA 1155, dual core 2.3GHz, 3M cache, 35W, compatible with CF-1156C-R20 CPU cooler
SAIDE-KIT01-R10	SATA to IDE/CF converter board
TPM-IN01-R20	20-pin Infineon TPM module, software management tool, firmware v3.17

PCI/PICoE Backplane

Selection Guide

PAC series wall-mount chassis

4U rack-mount chassis

	PCIe/PCI	PCIe/ PCI	HPE-3S1	HPE-3S2	HPE-4S1	HPE-4S2	HPE-5S1	HPE-5S2	HPE-6S1	HPE-8S
Total Slot			3	3	4	4	5	5	6	7
Expansion Slots	PCI		2	1	3	2	4	3	4	4
	PCIe	x4		1		1		1	1	
		x1								
Chassis			N/A	N/A	PAC-42GH PAC-400G	PAC-42GH PAC-400G	PR-1500G RACK-500G	PR-1500G RACK-500G	N/A	N/A

HPE-3S1-R41

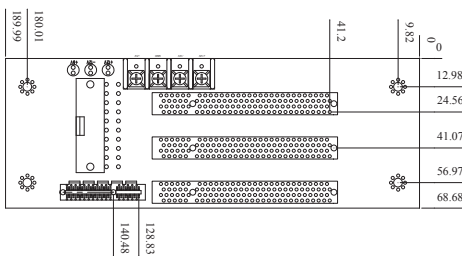
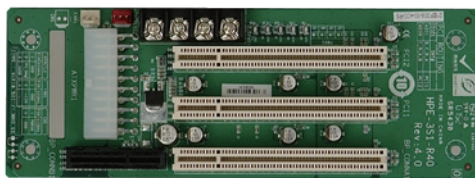

Ordering Information

HPE-3S1-R41 3-slot backplane with two PCI slots

HPE-4S1-R41

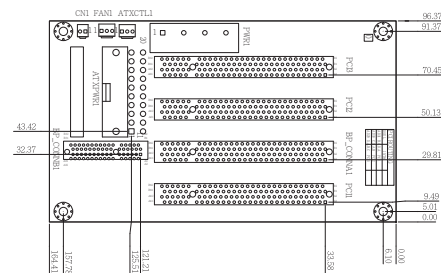
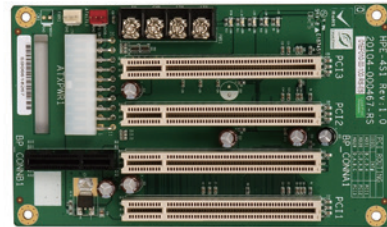

Ordering Information

HPE-4S1-R41 4-slot backplane with three PCI slots
 PAC-42GH 4-slot half-size compact chassis
 PAC-400G 4-slot half-size compact chassis

HPE-3S2-R41

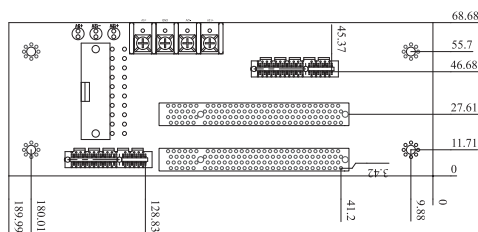
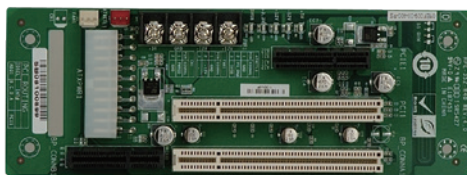

Ordering Information

HPE-3S2-R41 3-slot backplane with one PCI slot and one PCIe x4 slot

HPE-4S2-R41

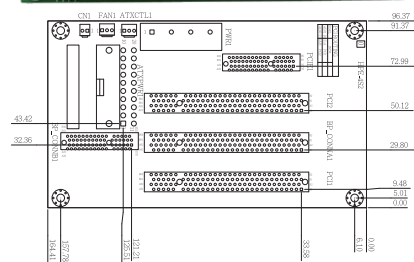
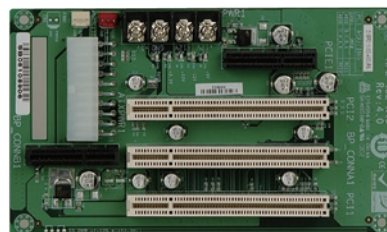

Ordering Information

HPE-4S2-R41 4-slot backplane with two PCI slots and one PCIe x4 slot
 PAC-42GH 4-slot half-size compact chassis
 PAC-400G 4-slot half-size compact chassis

HPE-5S1-R51

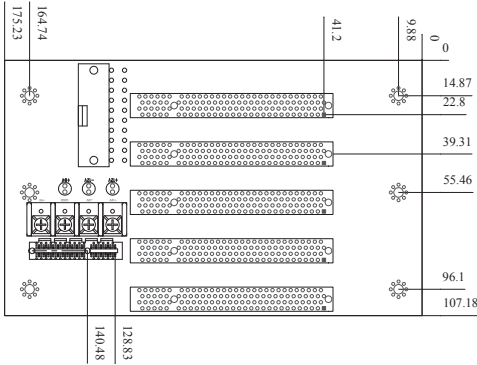
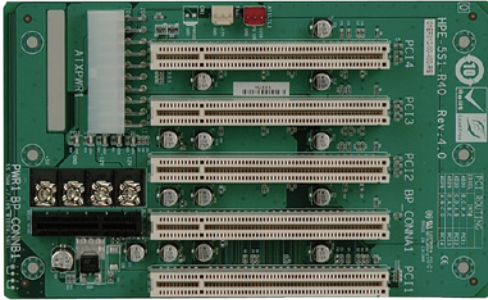

Ordering Information

HPE-5S1-R51	5-slot backplane with four PCI slots
PR-1500G	5-slot half-size compact chassis
RACK-500G	5U 5-slot full-size rack-mount chassis

HPE-6S1-R41

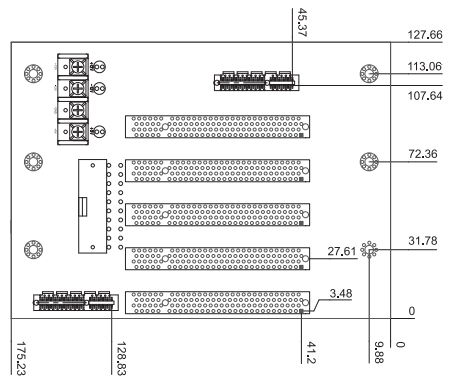
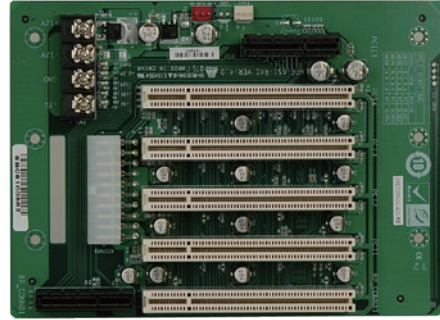

Ordering Information

HPE-6S1-R41	6-slot backplane with four PCI slots and one PCIe x4 slot
-------------	---

HPE-5S2-R40

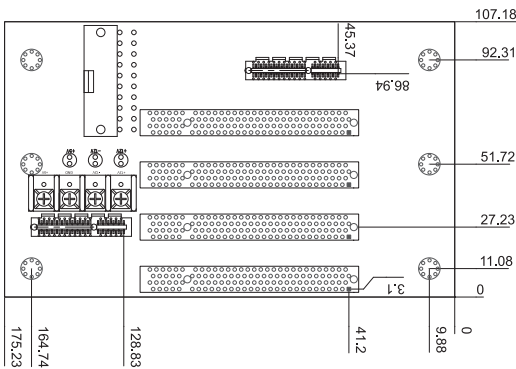
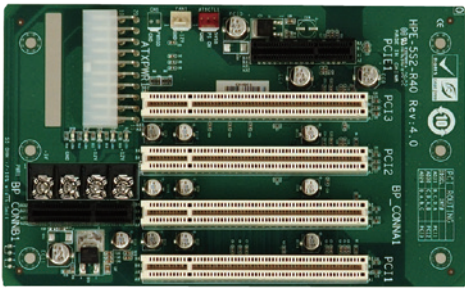

Ordering Information

HPE-5S2-R40	5-slot backplane with three PCI slots and one PCIe x4 slot
PR-1500G	5-slot half-size compact chassis
RACK-500G	5U 5-slot full-size rack-mount chassis

HPE-8S0-R41

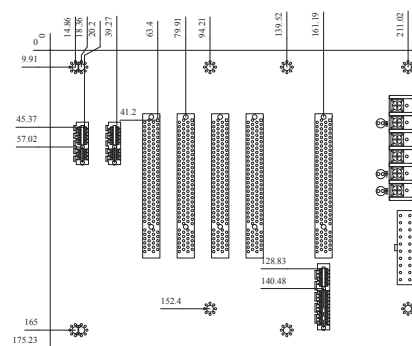
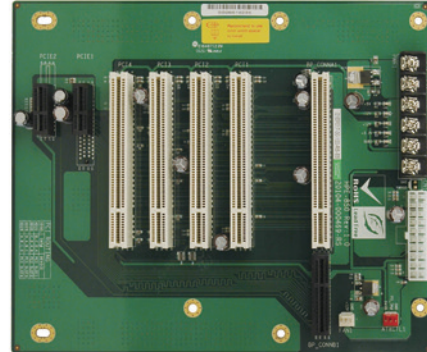

Ordering Information

HPE-8S0-R41	7-slot backplane with four PCI slots and two PCIe x1 slots
-------------	--

PCISA-BT

Half-size PCISA CPU Card supports 22nm Intel® Atom™ On-board SoC with VGA, iDP, Dual Intel® PCIe GbE, USB 3.1 Gen 1 (5Gb/s), PCIe Mini, SATA, mSATA, COM, Audio and RoHS

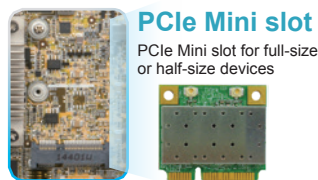
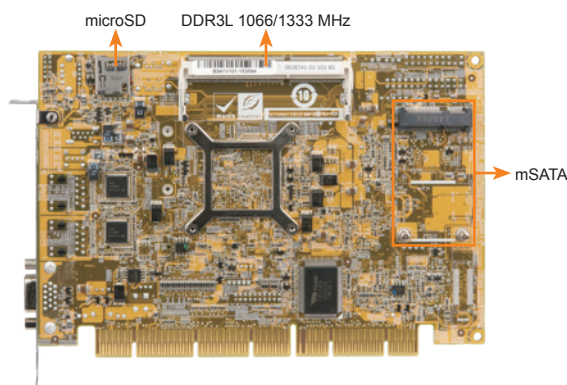
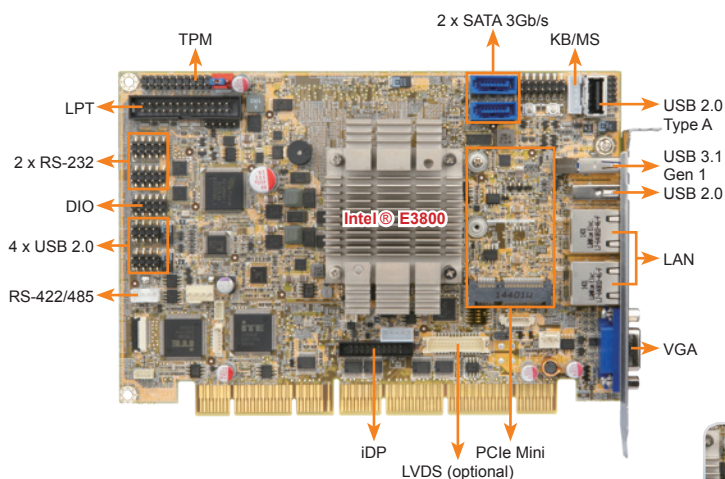

PCIe Mini slot

PCIe Mini slot for full-size or half-size devices

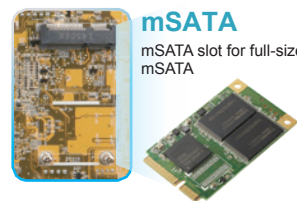

mSATA

mSATA slot for full-size mSATA

Specifications

- ◆ SoC
 - Intel® Atom™ E3845 on-board SoC (1.91GHz, quad-core, 2MB cache, TDP=10W)
 - Intel® Atom™ E3827 on-board SoC (1.75GHz, dual-core, 1MB cache, TDP=8W)
 - Intel® Atom™ E3826 on-board SoC (1.46GHz, dual-core, 1MB cache, TDP=7W)
 - Intel® Atom™ E3825 on-board SoC (1.33GHz, dual-core, 1MB cache, TDP=6W)
 - Intel® Atom™ E3815 on-board SoC (1.46GHz, single-core, 512KB cache, TDP=5W)
- ◆ Memory
 - One 204-pin 1333/1066 MHz single-channel DDR3L SDRAM unbuffered SO-DIMM slot supports up to 8GB
- ◆ Graphics Engine
 - Intel® HD Graphics Gen 7 Engines with 4 execution units, supporting DX11.1, OpenGL 4.2 and OpenCL1.2
- ◆ Display Output
 - Dual independent display
 - 1 x VGA (up to 2560x1600@60Hz)
 - 1 x 18/24-bit dual-channel LVDS (up to 1920x1200@60Hz) (optional, MOQ: 100 pcs/lot)
 - 1 x iDP interface for HDMI, LVDS, VGA, DVI, DP (up to 2560x1600@60Hz)
- ◆ Ethernet
 - LAN1: Intel® I211-AT PCIe controller
 - LAN2: Intel® I211-AT PCIe controller
- ◆ External I/O Interface
 - 1 x USB 2.0
 - 1 x USB 3.1 Gen 1 (5Gb/s)
- ◆ Internal I/O Interface

1 x KB/MS (1x6 pin)	1 x USB 2.0 (180° Type-A)
1 x LPT (2x13 pin)	2 x RS-232 (2x5 pin, P=2.54)
1 x mSATA	2 x SATA 3Gb/s
1 x RS-422/485 (1x4 pin, P=2.0)	4 x USB 2.0 (2x4 pin, P=2.54)
- ◆ Audio
 - Supports 7.1-channel HD Audio by IEI AC-KIT-892HD kit
 - 1 x Front Audio (2x5 pin)
- ◆ TPM
 - 1 x TPM (2x10 pin)
- ◆ SMBus
 - 1 x SMBus (1x4 pin)
- ◆ I²C
 - 1 x I²C (1x4 pin)
- ◆ Infrared Interface
 - 1 x Infrared interface (1x5 pin)
- ◆ Expansion
 - 1 x microSD socket
 - 1 x PCIe Mini slot
 - PCI and ISA signal via golden finger
- ◆ Watchdog Timer
 - Software programmable supports 1~255 sec. system reset
- ◆ Digital I/O
 - 8-bit digital I/O (2x5 pin)
- ◆ Fan Connector
 - 1 x CPU smart fan (1x4 pin)
 - 1 x System smart fan (1x3 pin)
- ◆ Power Supply
 - 5V/12V, AT/ATX support
- ◆ Power Consumption
 - 5V@1.55A, 12V@0.74A (Intel® Atom™ E3845 1.91GHz CPU with one 8 GB 1333 MHz memory)
- ◆ Operating Temperature
 - 20°C ~ 60°C
- ◆ Storage Temperature
 - 30°C ~ 70°C
- ◆ Dimensions
 - 185 mm x 128 mm
- ◆ Weight
 - GW: 1000g / NW: 250g
- ◆ CE/FCC compliant



Features

- Half-size PCISA CPU card supports 22nm Intel® Atom™ or Celeron® on-board SoC
- Supports dual LAN by Intel® I211-AT PCIe controllers
- Supports 1.35 V 1333/1066 MHz DDR3L SDRAM up to 8 GB
- Supports dual independent display with one analog CRT, iDP and one 24-bit dual-channel LVDS (optional)
- COM, USB 3.1 Gen 1 (5Gb/s), SATA 3Gb/s, PCIe Mini, mSATA and HD Audio support
- IEI One Key Recovery solution allows you to create rapid OS backup and recovery

Packing List

1 x PCISA-BT single board computer	
1 x SATA cable	1 x QIG

Ordering Information

Part No.	Description
PCISA-BT-E38451-R11	Half-size PCISA CPU card supports Intel® Atom™ E3845 (10W) on-board SoC with VGA, iDP, dual Intel® PCIe GbE, PCIe Mini, USB 3.1 Gen 1 (5Gb/s), SATA, mSATA, COM, Audio and RoHS
PCISA-BT-E38251-R11	Half-size PCISA CPU card supports Intel® Atom™ E3825 (6W) on-board SoC with VGA, iDP, dual Intel® PCIe GbE, PCIe Mini, USB 3.1 Gen 1 (5Gb/s), SATA, mSATA, COM, Audio and RoHS
19800-000049-RS	LPT flat cable, 240mm, P=2.54
19800-000075-RS	PS/2 KB/MS cable with bracket, 220mm, P=2.0
19800-020100-100-RS	RS-232 cable with bracket, Dual 10-pin to dual DB-9, 230mm, P=2.54
32102-000100-200-RS	SATA power cable, MOLEX 5264-4P to SATA15P
32205-003800-300-RS	RS-422/485 cable, 200mm, P=2.0
AC-KIT-892HD-R10	Realtek ALC892 7.1-channel HD Audio peripheral board
DP-DP-R10	DisplayPort to DisplayPort converter board (for IEI iDP connector)
DP-DVI-R10	DisplayPort to DVI-D converter board (for IEI iDP connector)
DP-HDMI-R10	DisplayPort to HDMI converter board (for IEI iDP connector)
DP-LVDS-R10	DisplayPort to LVDS converter board (for IEI iDP connector)
DP-VGA-R10	DisplayPort to VGA converter board (for IEI iDP connector)
TPM-IN01-R20	20-pin Infineon TPM module, software management tool, firmware v3.17

Note: Models with other CPUs not listed in the table are requested by MOQ - 100 pcs/lot.

IP/IPX Series Backplane

Supports PCI and ISA slot on one backplane!
For half-size PCISA series single board computers

The advantages of using the PCISA card are numerous:

1. Supports standard PISA version 1.0 slot on the IP/IPX series passive backplane.
2. Compatible with all available PCI/ISA cards. IP/IPX backplane is also integrated with the PCISA series card slot.

Selection Guide

PAC series wall-mount chassis 4U rack-mount chassis



Model	IP-3S-RS	IP-4S-RS	IP-4S2A-RS	IP-4S4-RS	IP-5SA2-RS
Total Slot	3	4	4	4	5
PCI Slot	2	3	3		4
ISA Slot				3	
PSU Type	AT	AT	ATX	AT	ATX
Chassis	PAC-53GH	PAC-400G PAC-42GH	PAC-400G	PAC-400G PAC-42GH	PR-1500G



Model	IP-6S-RS	IP-6SA-RS	IPX-9S-RS	IP-10S-RS	IPX-13S-RS
Total Slot	6	6	9	10	13
PCI Slot	3	3	8	4	12
ISA Slot	2	2		5	
PSU Type	AT	ATX	ATX/AT	ATX/AT	ATX/AT
Chassis	PAC-1000G	PAC-106G PAC-1000G	PAC-125G	PAC-125G	RACK-305G RACK-360G RACK-3000G

IP-3S-RS-R40

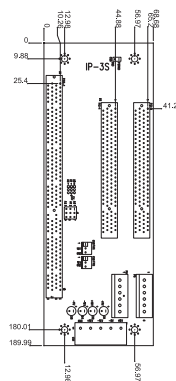
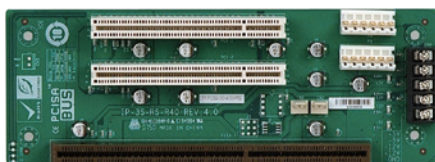

IP-4S-RS-R40

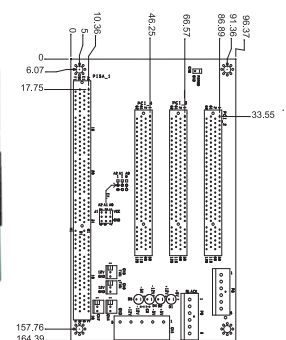
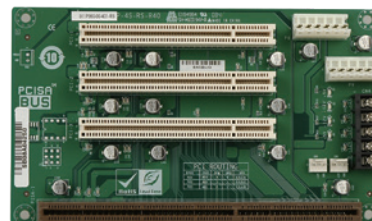

Ordering Information	
IP-3S-RS-R40	3-slot backplane with two PCI slots
PAC-53GH	3-slot half-size compact chassis

Ordering Information	
IP-4S-RS-R40	4-slot backplane with three PCI slots
PAC-400G	4-slot half-size compact chassis
PAC-42GH	4-slot half-size compact chassis

IP-4S2A-RS-R40

ATX power

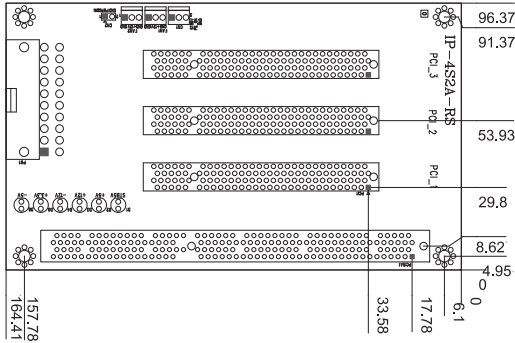
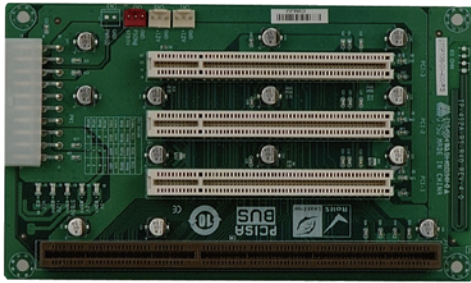

Ordering Information

IP-4S2A-RS-R40	4-slot backplane with three PCI slots
PAC-400G	4-slot half-size compact chassis

IP-5SA2-RS-R40

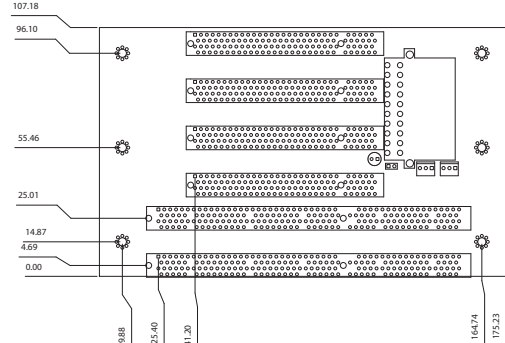
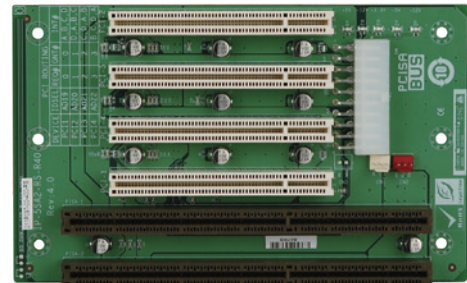

Ordering Information

IP-5SA2-RS-R40	5-slot backplane with four PCI slots
PR-1500G	5-slot half-size compact chassis

IP-4S4-RS-R40

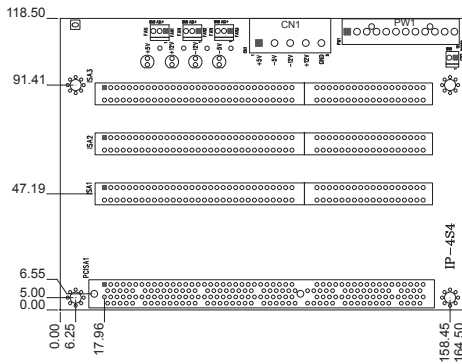
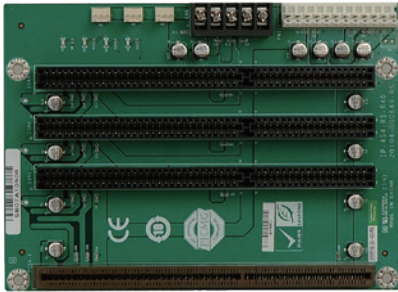

Ordering Information

IP-4S4-RS-R40	4-slot backplane with three ISA slots
PAC-400G	4-slot half-size compact chassis
PAC-42GH	4-slot half-size compact chassis

IP-6S-RS-R40

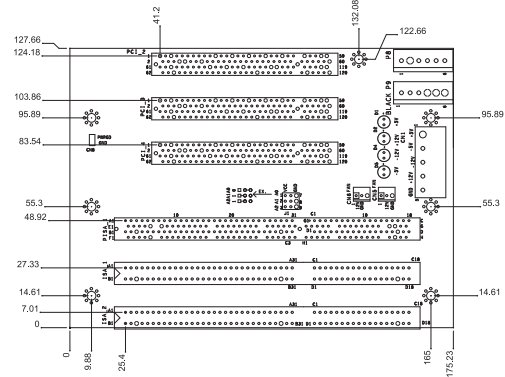
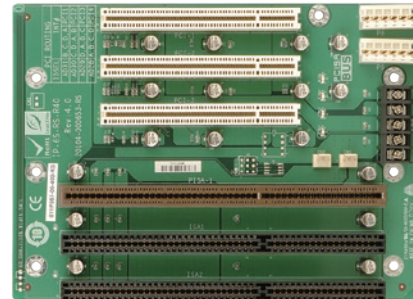

Ordering Information

IP-6S-RS-R40	6-slot backplane with three PCI slots and two ISA slots
PAC-1000G	6-slot full-size compact chassis

IP-6SA-RS-R40

ATX power

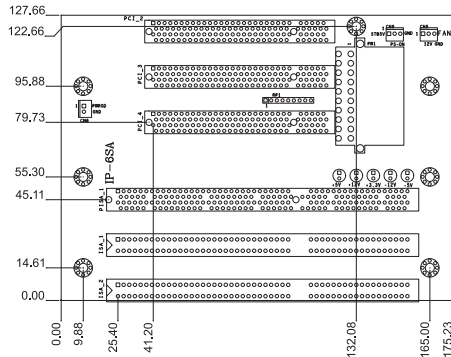
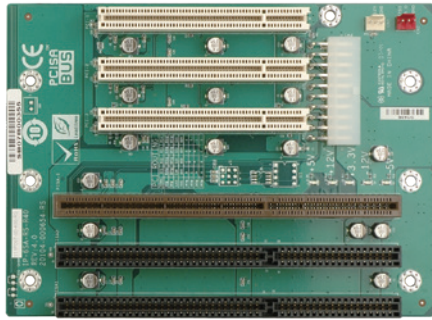

Ordering Information

IP-6SA-RS-R40	6-slot backplane with three PCI slots and two ISA slots
PAC-106G	6-slot full-size compact chassis
PAC-1000G	6-slot full-size compact chassis

IP-10S-RS-R40

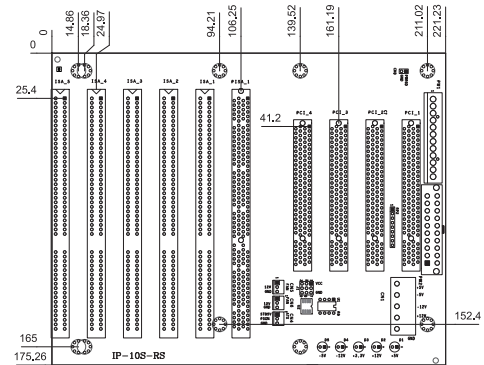
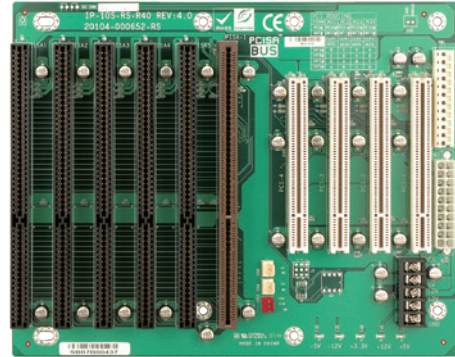

Ordering Information

IP-10S-RS-R40	10-slot backplane with four PCI slots and five ISA slots
PAC-125G	10-slot full-size compact chassis

IPX-9S-RS-R41

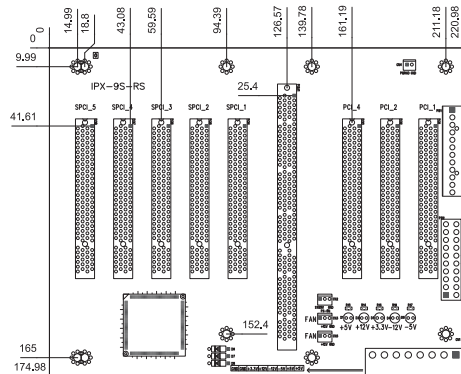
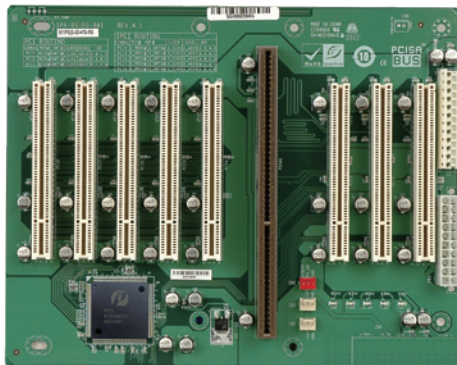

Ordering Information

IPX-9S-RS-R41	9-slot backplane with eight PCI slots
PAC-125G	10-slot full-size compact chassis

IPX-13S-RS-R40

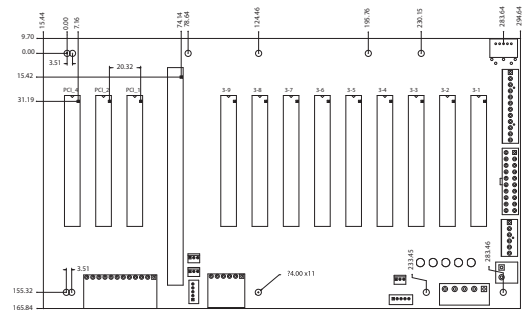
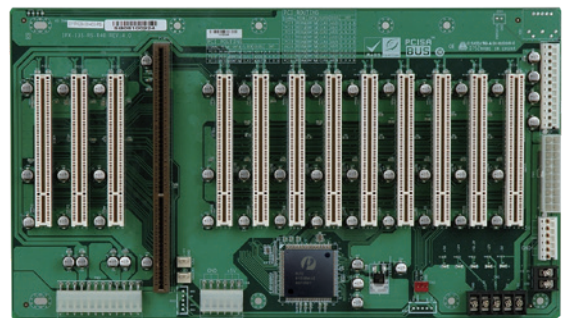

Ordering Information

IPX-13S-RS-R40	13-slot backplane with twelve PCI slots
RACK-305G	4U 14-slot rack-mount chassis
RACK-360G	4U 14-slot rack-mount chassis
RACK-3000G	4U 14-slot rack-mount chassis

IOWA-LX

Half-size Pure ISA CPU Card with On-board AMD Geode™ LX600 Processor (366 MHz), 128KB L2 cache, On-board 128MB Memory, VGA, LAN, USB 2.0, CF, COM, LPT, Audio and RoHS

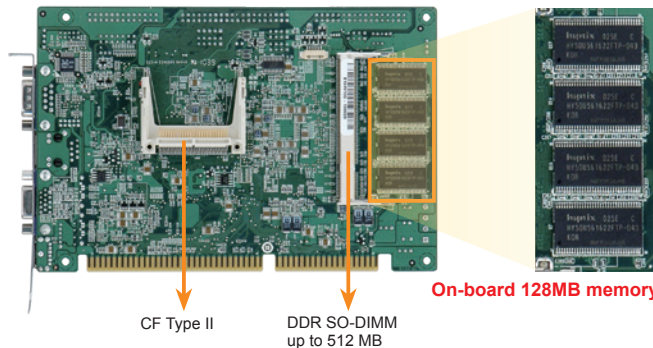
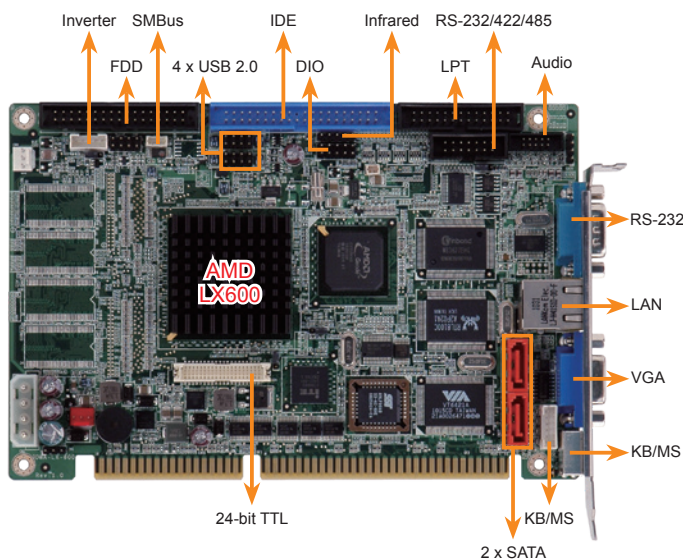

Performance Comparison Chart

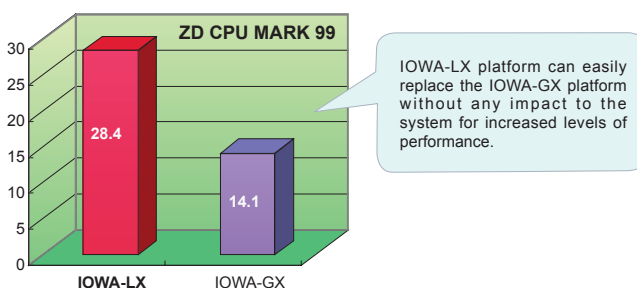

Specifications

- ◆ CPU
 - On-board AMD Geode™ LX600 processor (366 MHz), 128KB L2 cache
- ◆ Chipset
 - AMD Geode™ CS5536
- ◆ BIOS
 - Award BIOS
- ◆ Memory
 - One 200-pin 266/200 MHz DDR SDRAM SO-DIMMs supports up to 512MB
 - On-board 128MB DDR 266/200 MHz memory
- ◆ Graphics Engine
 - VGA integrated in the AMD Geode™ LX600
- ◆ Display Output
 - Single HD VOP 2.0 output
 - 1 x VGA (up to 1920x1440)
 - 1 x TFT (up to 1600x1200)
- ◆ External I/O Interface
 - 1 x KB/MS
 - 1 x RS-232
- ◆ Internal I/O Interface
 - 1 x CF Type II
 - 1 x RS-232/422/485 (2x7 pin, P=2.54)
 - 1 x FDD (2x17 pin)
 - 1 x LPT (2x13 pin)
 - 1 x IDE (2x10 pin)
 - 4 x USB 2.0 (2x4 pin, P=2.54)
 - 2 x SATA (RAID 0/1 supported on IOWA-LX-600S-R10)
- ◆ Ethernet
 - 10/100Mbps Realtek RTL8100C Ethernet controller
- ◆ Audio
 - Realtek ALC203 with AC'97 codec
 - 1 x Front audio (2x5 pin)
- ◆ Expansion
 - ISA bus supported via golden finger
- ◆ Digital I/O
 - 8-bit digital I/O (2x5 pin)
- ◆ Infrared Interface
 - 1 x Infrared Interface (1x5 pin)
- ◆ Watchdog Timer
 - Software programmable supports 1~255 sec. system reset
- ◆ FAN connector
 - 1 x Smart fan (1x3 pin)
- ◆ Power supply
 - 5V/12V, AT/ATX support
- ◆ Power Consumption
 - 5V@1.51A, 5Vsb@0.09A
 - (On-board AMD Geode™ LX 600 CPU 366 MHz with 128MB 200 MHz on-board DDR memory and 512MB 333 MHz DDR memory)
- ◆ Operating Temperature
 - 10°C ~ 60°C
- ◆ Storage Temperature
 - 20°C ~ 70°C
- ◆ Operating Humidity
 - 5% ~ 95%, non-condensing
- ◆ Weight
 - GW: 1000g / NW: 250g
- ◆ CE/FCC compliant



Features

- ISA CPU card with on-board AMD Geode™ LX600 processor (366 MHz), 128KB L2 cache
- Flexible on-board DDR SDRAM and one SO-DIMM slot
- Enhanced TTL, RS-232, RS-422/485 and USB 2.0 interfaces for extended connectivities
- IEI One Key Recovery solution allows you to create rapid OS backup and recovery

Packing List

1 x IOWA-LX-600 single board computer
1 x Audio cable
1 x IDE flat cable
1 x KB/MS Y cable
1 x USB cable
1 x Mini jumper pack
1 x QIG

Ordering Information

Part No.	Description
IOWA-LX-600-R10	Half-size pure ISA CPU card with on-board AMD Geode™ LX600 processor (366 MHz), 128KB L2 cache, on-board 128MB memory, VGA, LAN, USB 2.0, COM, CF, LPT, audio and RoHS
IOWA-LX-600S-R10	Half-size pure ISA CPU card with on-board AMD Geode™ LX600 processor (366 MHz), 128KB L2 cache, on-board 128MB memory, VGA, LAN, USB 2.0, SATA, CF, COM, LPT, Audio and RoHS
19800-000049-RS	LPT flat cable, 240mm, P=2.54
19800-004400-200-RS	RS-232 & RS-422/485 cable with bracket, 14-pin to two DB-9, 255mm, P=2.54
32801-000703-500-RS	SATA (7-pin to 7-pin) cable, 500mm
32200-000017-RS	FDD Cable, 520mm, P=2.54

BP Series Backplane

Selection Guide

PAC series wall-mount chassis 4U rack-mount chassis



Model	BP-3S-RS-R40	BP-4S-RS-R40	BP-5S-RS-R40	BP-6S-RS-R40	BP-7S-RS-R40	BP-8S-RS-R41	BP-10S-RS-R40
Total Slot	3	4	5	6	7	8	10
ISA Slot	3	4	5	6	7	8	10
PSU Type	AT	AT	AT	AT	AT	AT	AT
Chassis	PAC-53GH	PAC-400G PAC-42GH	PR-1500G	PAC-106G PAC-1000G	PAC-700G PAC-1700G	N/A	PAC-125G

BP-3S-RS-R40

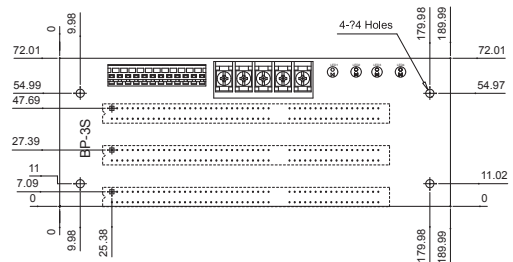
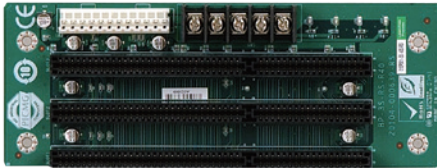

Ordering Information

- BP-3S-RS-R40 3-slot backplane with three ISA slots
- PAC-53GH 3-slot half-size compact chassis

BP-4S-RS-R40

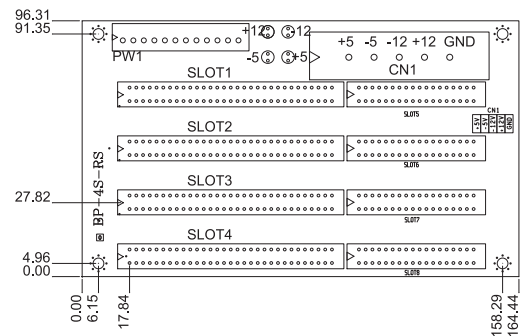
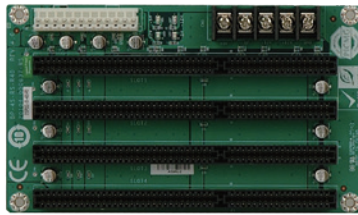

Ordering Information

- BP-4S-RS-R40 4-slot backplane with four ISA slots
- PAC-400G 4-slot half-size compact chassis
- PAC-42GH 4-slot half-size compact chassis

BP-5S-RS-R40

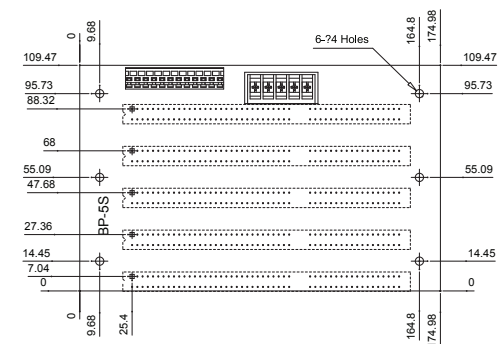
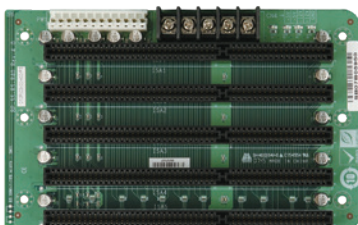

Ordering Information

- BP-5S-RS-R40 5-slot backplane with five ISA slots
- PR-1500G 5-slot half-size compact chassis

BP-6S-RS-R40

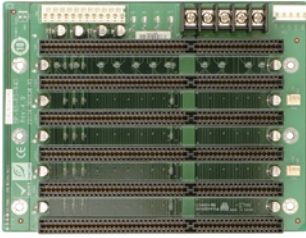

Ordering Information

BP-6S-RS-R40	6-slot backplane with six ISA slots
PAC-106G	6-slot full-size compact chassis
PAC-1000G	6-slot full-size compact chassis

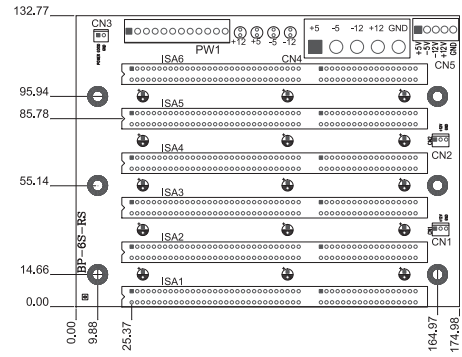

BP-7S-RS-R40

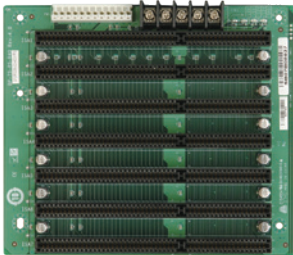

Ordering Information

BP-7S-RS-R40	7-slot backplane with seven ISA slots
PAC-700G	7-slot half-size compact chassis
PAC-1700G	7-slot full-size compact chassis

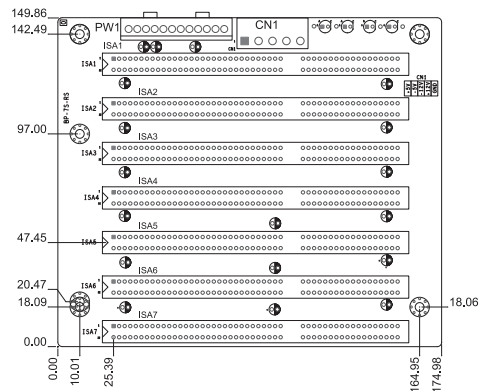

BP-8S-RS-R41

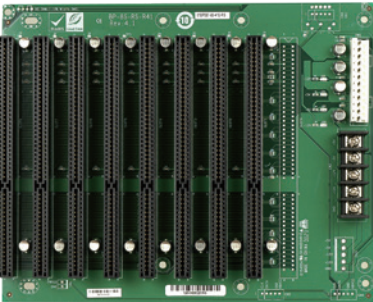

Ordering Information

BP-8S-RS-R41	8-slot backplane with eight ISA slots
--------------	---------------------------------------

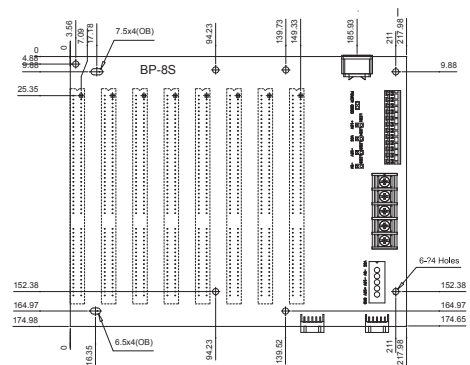

BP-10S-RS-R40

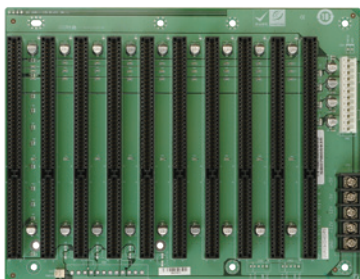

Ordering Information

BP-10S-RS-R40	10-slot backplane with ten ISA slots
PAC-125G	10-slot full-size compact chassis

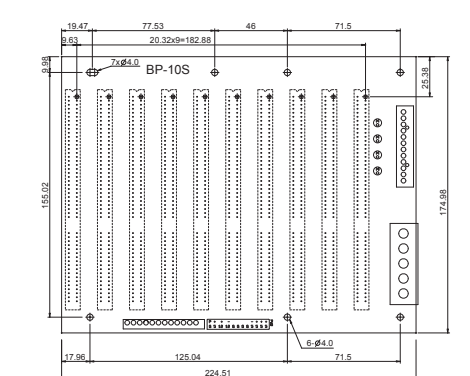

AC-KIT-892HD

Realtek ALC892 7.1-Channel HD Audio Peripheral Board, RoHS

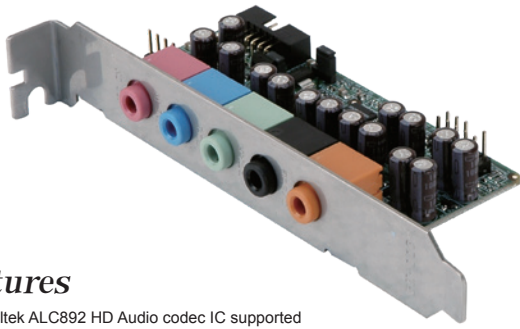

Features

- Realtek ALC892 HD Audio codec IC supported
- Five audio jacks for microphone, 7.1+2-channel high definition audio input and output
- High performance 7.1+2-channel high definition audio board provides 7.1-channel sound playback and multiple streaming through the front panel stereo outputs
- Digital to Analog Converter (DAC) with 97dB Signal to Noise Ratio (SNR)
- Analog to Digital Converter (ADC) with 90dB Signal to Noise Ratio (SNR)
- All the Digital to Analog Converter (DAC) supports 44.1k/48k/96k/192kHz sampling rate
- All the Analog to Digital Converter (ADC) supports 44.1k/48k/96kHz sampling rate
- Driver supports Windows® 2000/2003/XP/VISTA/7 (32/64 bits) and Linux (Ubuntu or Debian)
- CE/FCC compliant

Packing List

1 x AC-KIT-892HD audio peripheral board	
1 x Audio cable	1 x QIG

Dimensions (Unit: mm)

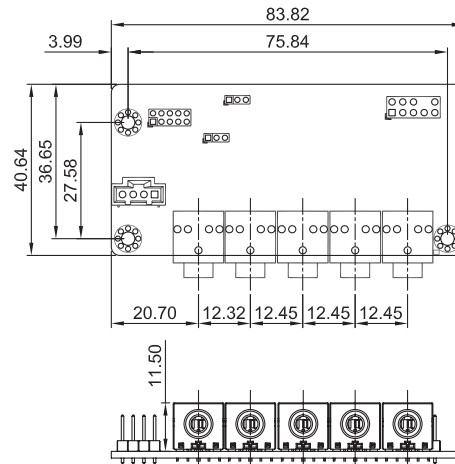

Ordering Information

AC-KIT-892HD-R10	Realtek ALC892 7.1-channel HD Audio peripheral board
32107-001100-100-RS	Audio cable with length of 200 mm, 2 x 5-pin, pitch=2.0 mm

AC-KIT08R

Audio Converter Card via Realtek ALC655 AC'97 5.1-Channel Audio Daughter Board, RoHS



Features

- Realtek ALC655 AC'97 audio codec IC supported
- Three audio jacks for microphone, 5.1-channel AC'97 audio input and output
- Full duplex AC'97 2.3 compatible 5.1-channel audio codec designed for PC multimedia system
- Supports double sampling rate (96kHz) of DVD audio playback
- Driver supports Windows® 2000/2003/XP/VISTA/7 (32/64 bits) and Linux (Ubuntu or Debian)
- CE/FCC compliant

Packing List

1 x AC-KIT08R audio peripheral board	
1 x Audio cable	1 x QIG

Dimensions (Unit: mm)

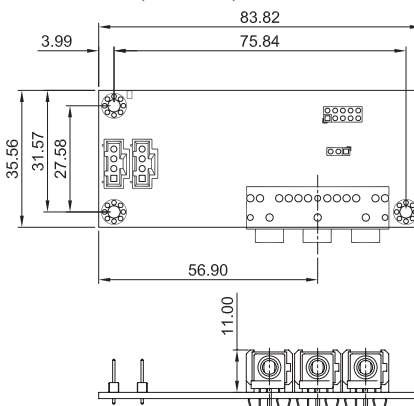

Ordering Information

AC-KIT08R-R10	Realtek ALC655 AC'97 5.1-channel audio peripheral board
32107-001100-100-RS	Audio cable with length of 200 mm, 2 x 5-pin, pitch=2.0 mm

IO-KIT-001-R20

DVI and 4 x USB 1.1/2.0 Translation Daughter Board with Bracket, RoHS

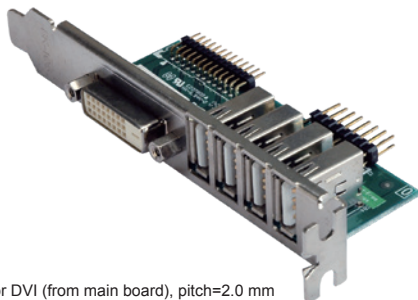

Features

- 26-pin header for DVI (from main board), pitch=2.0 mm
- 2 x 8-pin header for USB 1.1/2.0 (from main board, four sets), pitch=2.54 mm
- DVI-D connector on edge
- Four USB 1.1/2.0 connectors on edge
- CE/FCC compliant

Dimensions (Unit: mm)

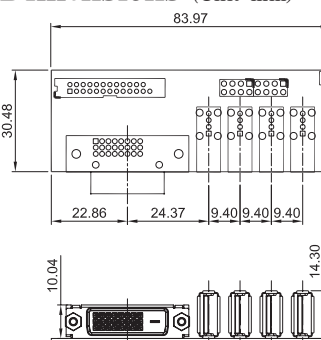

Packing List

1 x IO-KIT-001-R20 (DVI and four USB 1.1/2.0 translation daughter board)
1 x DVI cable
1 x USB cable
1 x QIG

Ordering Information

IO-KIT-001-R20	DVI and four USB 1.1/2.0 translation daughter board
32001-009900-100-RS	USB cable with length of 200 mm, 2 x 8-pin, pitch=2.54 mm
32104-000100-100-RS	DVI cable with length of 200 mm, 2 x 13-pin, pitch=2.0 mm